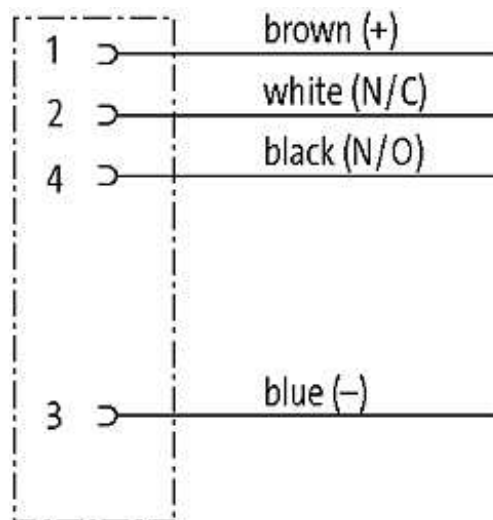

**M8 FEMALE 0° F&B**

PVC 4x0.25 GRAY, UL/CSA 3m

Female straight  
4-pole

Plastic housings with good resistance against chemicals and oils. The resistance to aggressive media should be individually tested for your application. Further details on request. Further cable lengths on request.

[Link to Product](#)**Illustration**

# Female

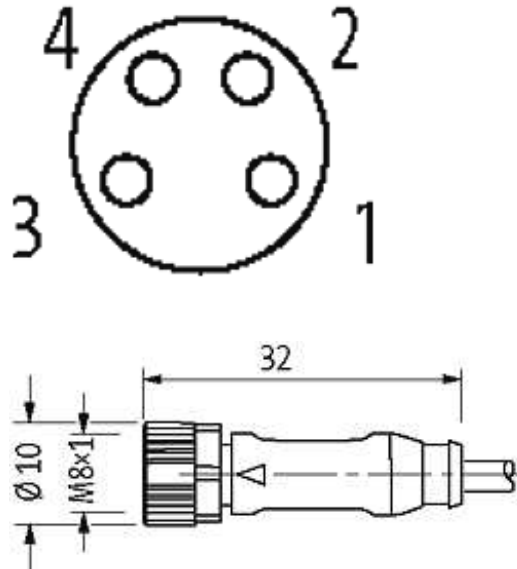

Product may differ from Image

## Approvals



## Form

Form 08061

## Cables

Cable number	211
No./diameter of wires	4 × 0.25 mm <sup>2</sup>
Wire isolation	PVC (br, wh, bl, bk)
Jacket Color	gray
Shore hardness outer jacket	85 ± 5A
Material (jacket)	PVC (UL/CSA)
Outer Ø	approx. 4.8 mm
Bend radius (fixed)	5 × outer Ø
Bend radius (moving)	10 × outer Ø
Temperature range (fixed)	-30...+80 °C
Temperature range (mobile)	-5...+80 °C

## General data

Temperature range -25...+85 °C, depending on cable quality

**Technical Data**

Operating voltage	max. 30 V AC/DC
Operating current per contact	max. 4 A
Locking of ports	Screw thread M8 × 1 mm (recommended torque 0.4 Nm) self-securing
Protection	IP65, IP66K, IP67, IP68 inserted and tightened (EN 60529)
Locking material	Stainless Steel 1.4404 (V4A)

**Commercial data**

country of origin	DE
customs tariff number	85444290
minimum order quantity	1