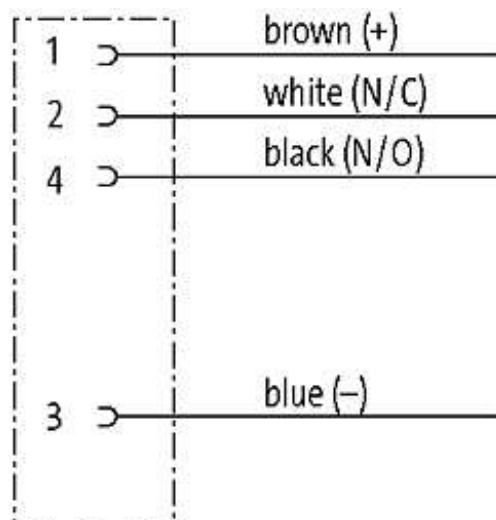
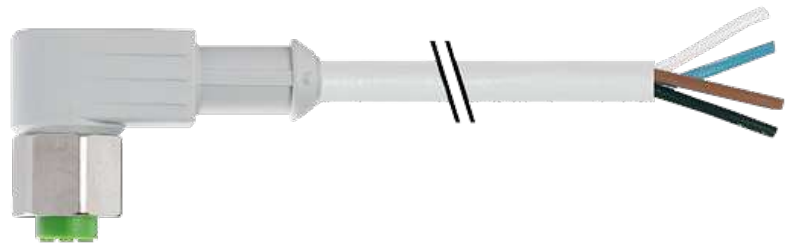

M12 FEMALE 90° F&B

PVC 4X0.34 GRAY, 40m

Female 90°
4-pole
Profile gasket

Further cable lengths on request.

[Link to Product](#)**Illustration**

Female

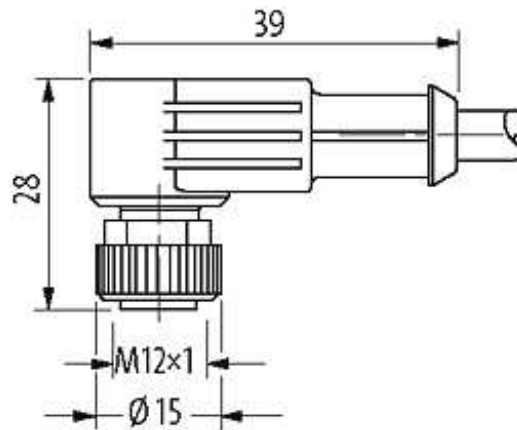

Product may differ from Image

Approvals



Form

Form 12341

Cables

Cable number	214
No./diameter of wires	4 × 0.34 mm ²
Wire isolation	PVC (br, wh, bl, bk)
Jacket Color	gray
Shore hardness outer jacket	85 ± 5A
Material (jacket)	PVC (UL/CSA)
Outer Ø	approx. 5.0 mm
Bend radius (fixed)	5 × outer Ø
Bend radius (moving)	10 × outer Ø

The information in this brochure has been compiled with the utmost care.

Liability for the correctness completeness and topicality of the information is restricted to gross negligence. Version: 05/16

Temperature range (fixed)	-30...+80 °C
---------------------------	--------------

Temperature range (mobile)	-5...+80 °C
----------------------------	-------------

General data

Temperature range	-25...+85 °C, depending on cable quality
-------------------	--

Technical Data

Operating voltage	max. 250 V AC/DC
-------------------	------------------

Operating current per contact	max. 4 A
-------------------------------	----------

Locking of ports	Screw thread M12 × 1 mm (recommended torque 0.6 Nm) self-securing
------------------	---

Protection	IP65, IP66K, IP67, IP68 inserted and tightened (EN 60529)
------------	---

Locking material	Stainless Steel 1.4404 (V4A)
------------------	------------------------------

Commercial data

country of origin	DE
-------------------	----

customs tariff number	85444290
-----------------------	----------

minimum order quantity	1
------------------------	---