

M12 FEMALE 90° F&B

PVC 5X0.34 GRAY, 10m

F&B

Female 90°

5-pole

Profile gasket

Further cable lengths on request.

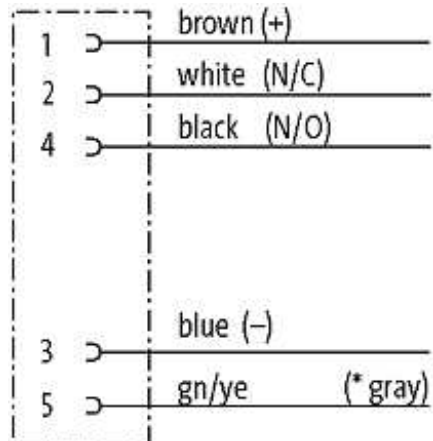
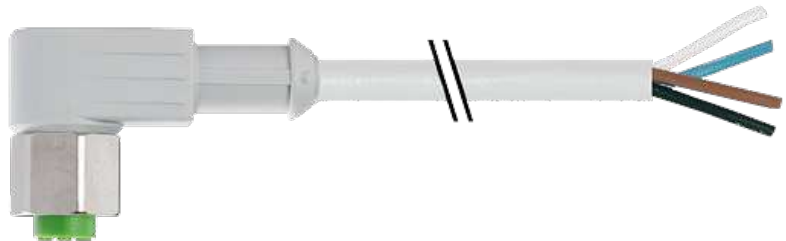
[Link to Product](#)**Illustration**

(* for cable type 126, 732, 219, 619)

Female

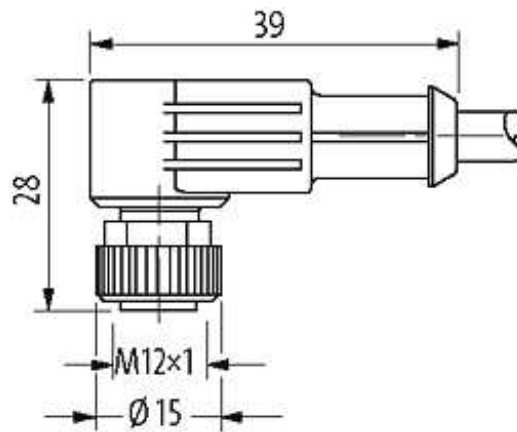
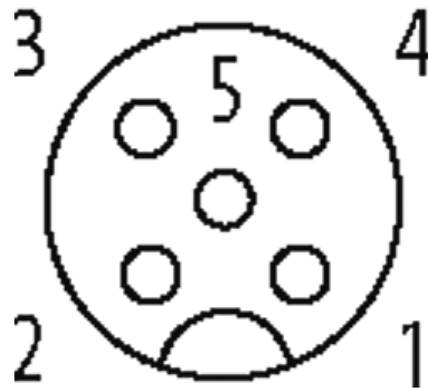

Product may differ from Image

Approvals



Form

Form 12361

Cables

Cable number	215
No./diameter of wires	5 × 0.34 mm ²
Wire isolation	PVC (br, wh, bl, bk, gnye)
Jacket Color	gray
Shore hardness outer jacket	85 ± 5A
Material (jacket)	PVC (UL/CSA)
Outer Ø	approx. 5.2 mm
Bend radius (fixed)	5 × outer Ø

The information in this brochure has been compiled with the utmost care.

Liability for the correctness completeness and topicality of the information is restricted to gross negligence. Version: 05/16

Bend radius (moving)	10 × outer Ø
Temperature range (fixed)	-30...+80 °C
Temperature range (mobile)	-5...+80 °C

General data

Temperature range	-25...+85 °C, depending on cable quality
-------------------	--

Technical Data

Operating voltage	max. 125 V AC/DC
Operating current per contact	max. 4 A
Locking of ports	Screw thread M12 × 1 mm (recommended torque 0.6 Nm) self-securing
Protection	IP65, IP66K, IP67, IP68 inserted and tightened (EN 60529)
Locking material	Stainless Steel 1.4404 (V4A)

Commercial data

country of origin	DE
customs tariff number	85444290
minimum order quantity	1