

M12 FEMALE 90° SHIELDED F&B

PVC 5X0.34 shielded GRAY, 3m

Female 90°
5-pole, shielded
Profile gasket

Plastic housings with good resistance against chemicals and oils. The resistance to aggressive media should be individually tested for your application. Further details on request. Further cable lengths on request.

[Link to Product](#)

Illustration

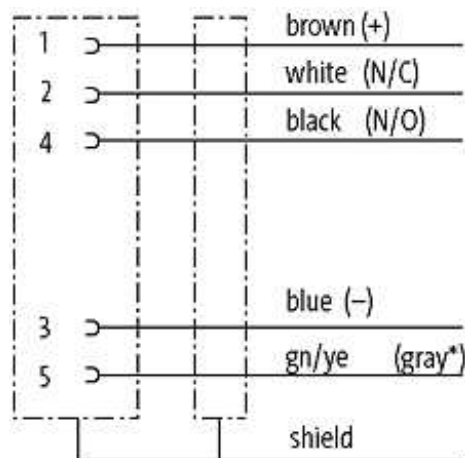
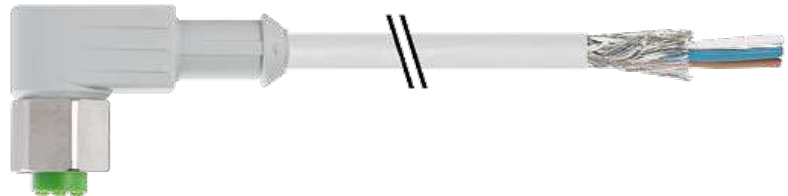

(* for cable type 203, 603, 243, 643)

Female

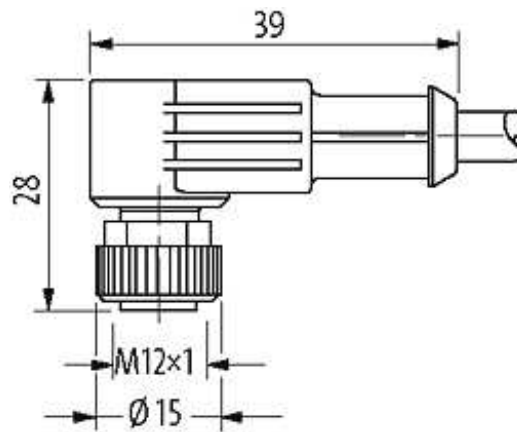
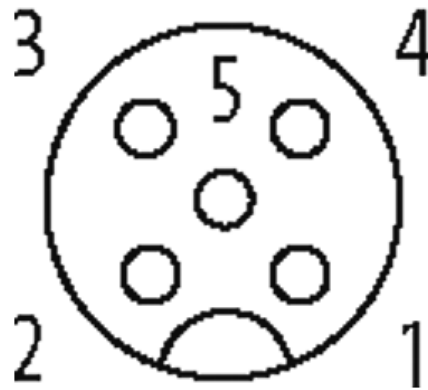

Product may differ from Image

Approvals



Form

Form 13281

Cables

Cable number	348
No./diameter of wires	5 × 0.34 mm ²
Wire isolation	PVC (br, wh, bl, bk, gnye)
Jacket Color	gray
Shore hardness outer jacket	80 ± 5A
Material (jacket)	PVC
Outer Ø	approx. 5.9 mm
Bend radius (fixed)	10 × outer Ø

The information in this brochure has been compiled with the utmost care.

Liability for the correctness completeness and topicality of the information is restricted to gross negligence. Version: 05/16

Bend radius (moving)	15 × outer Ø
Temperature range (fixed)	-30...+80 °C
Temperature range (mobile)	-5...+70 °C
Shielded	yes

General data

Temperature range	-25...+85 °C, depending on cable quality
-------------------	--

Technical Data

Operating voltage	max. 60 V AC/DC
Operating current per contact	max. 4 A
Locking of ports	Screw thread M12 × 1 mm (recommended torque 0.6 Nm) self-securing
Protection	IP65, IP66K, IP67, IP68 inserted and tightened (EN 60529)
Locking material	Stainless Steel 1.4404 (V4A)

Commercial data

country of origin	DE
customs tariff number	85444290
minimum order quantity	1