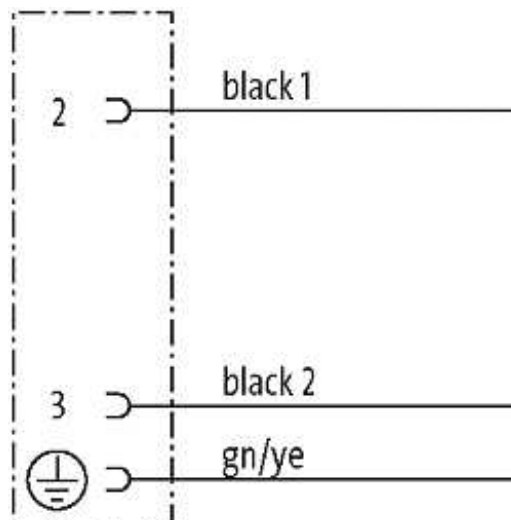

M12 FEMALE 90° C CODED

PUR 3X0.75 black 3m

Female 90°
M12, C-coded
3-pole

Plastic housings with good resistance against chemicals and oils. The resistance to aggressive media should be individually tested for your application. Further details on request. Further cable lengths on request.

[Link to Product](#)**Illustration**

Female

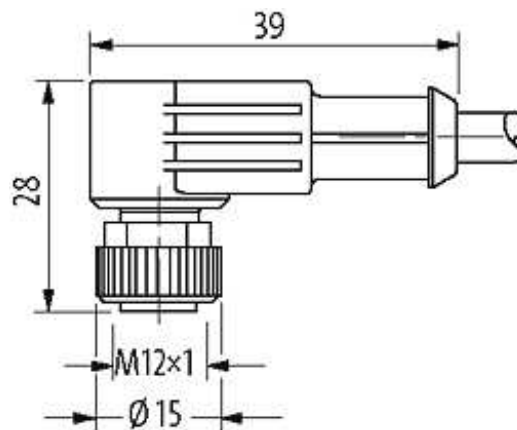
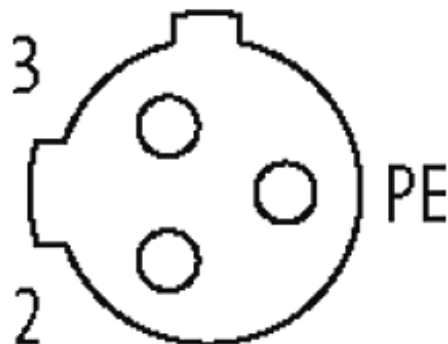

Product may differ from Image

Approvals



Form

Form 20121

Cables

Cable number	626
No./diameter of wires	3 × 0.75 mm ²
Wire isolation	PVC (bk num, gnye)
C-track properties	2 Mio.
Jacket Color	black
Shore hardness outer jacket	85 ± 5A
Material (jacket)	PUR/PVC (UL/CSA)
Outer Ø	approx. 5.9 mm
Bend radius (fixed)	10 × outer Ø

The information in this brochure has been compiled with the utmost care.

Liability for the correctness completeness and topicality of the information is restricted to gross negligence. Version: 05/16

Bend radius (moving)	15 × outer Ø
Temperature range (fixed)	-30...+80 °C
Temperature range (mobile)	-5...+80 °C

General data

Temperature range	-25...+85 °C, depending on cable quality
-------------------	--

Technical Data

Operating voltage	max. 250 V AC/DC
Operating current per contact	max. 4 A
Locking of ports	Screw thread M12 × 1 mm (recommended torque 0.6 Nm) self-securing
Protection	IP66K, IP67 inserted and tightened (EN 60529)
Locking material	PA

Commercial data

country of origin	DE
customs tariff number	85444290
minimum order quantity	1