

**M12-Steel female 90° with cable**

PVC 4x0.34 gy UL/CSA 5m

M12-Steel  
Female 90°  
4-pole[Link to Product](#)**Illustration**

# Female

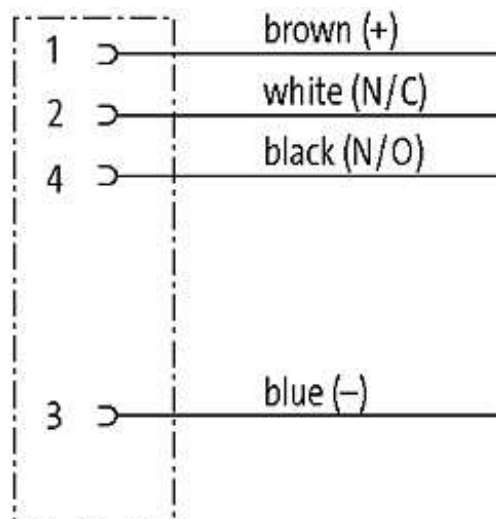
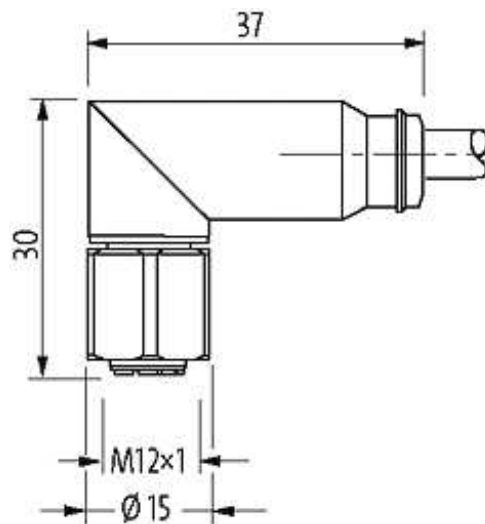

Product may differ from Image

## Approvals



## Form

Form 12341

## Cables

Cable number	214
No./diameter of wires	4 × 0.34 mm <sup>2</sup>
Wire isolation	PVC (br, wh, bl, bk)
Jacket Color	gray
Shore hardness outer jacket	85 ± 5A
Material (jacket)	PVC (UL/CSA)
Outer Ø	approx. 5.0 mm

Bend radius (fixed)	5 × outer Ø
Bend radius (moving)	10 × outer Ø
Temperature range (fixed)	-30...+80 °C
Temperature range (mobile)	-5...+80 °C

#### Technical Data

Operating voltage	max. 32 V AC/DC
Operating current per contact	max. 4 A
Locking of ports	Screw thread M12 × 1 mm (recommended torque 0.6 Nm) self-securing
Protection	IP65, IP66K, IP67, IP68, IP69K inserted and tightened (EN 60529)
Locking material	Stainless Steel 1.4404 (V4A)

#### Commercial data

country of origin	CZ
customs tariff number	85444290
minimum order quantity	1