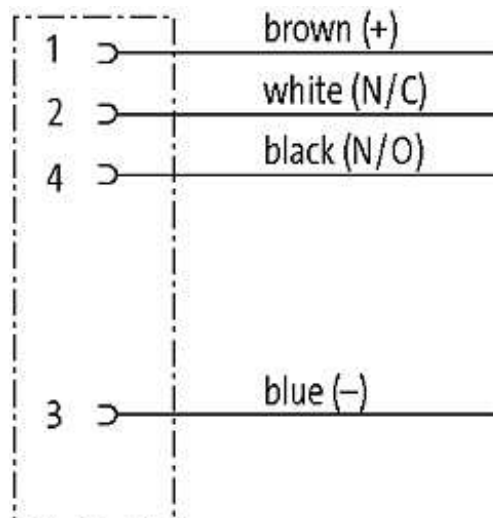

MQ12 FEMALE 0°

PVC 4X0.34 black 20m

Female straight
4-pole

Further cable lengths on request. Plastic housings with good resistance against chemicals and oils. The resistance to aggressive media should be individually tested for your application. Further details on request.

[Link to Product](#)**Illustration**

Female

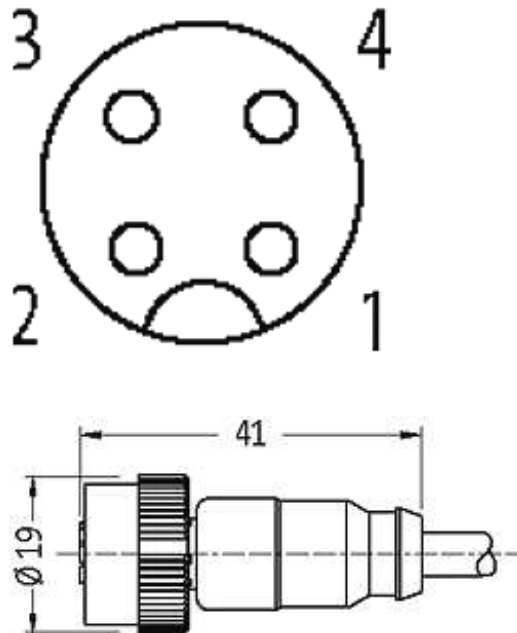

Product may differ from Image

Approvals



Form

Form 12221

Cables

Cable number	614
No./diameter of wires	4 × 0.34 mm ²
Wire isolation	PVC (br, wh, bl, bk)
Jacket Color	black
Shore hardness outer jacket	85 ± 5A
Material (jacket)	PVC (UL/CSA)
Outer Ø	approx. 5.0 mm
Bend radius (fixed)	5 × outer Ø
Bend radius (moving)	10 × outer Ø
Temperature range (fixed)	-30...+80 °C
Temperature range (mobile)	-5...+80 °C

General data

Temperature range -25...+85 °C, depending on cable quality

Technical Data

Operating voltage	max. 250 V AC/DC
Operating current per contact	max. 4 A
Locking of ports	Quick connection, 1/4 turn
Protection	IP67 inserted and tightened (EN 60529)

Commercial data

country of origin	DE
customs tariff number	85444290
minimum order quantity	1