

MQ12 female 0° with cable

PUR 5x0.34 bk UL/CSA+drag chain 40m

Female straight
5-pole

Further cable lengths on request. Plastic housings with good resistance against chemicals and oils. The resistance to aggressive media should be individually tested for your application. Further details on request.

[Link to Product](#)

Illustration



1	↷	brown (+)
2	↷	white (N/C)
4	↷	black (N/O)
3	↷	blue (-)
5	↷	gn/ye (* gray)

(* for cable type 126, 732, 219, 619)

Female

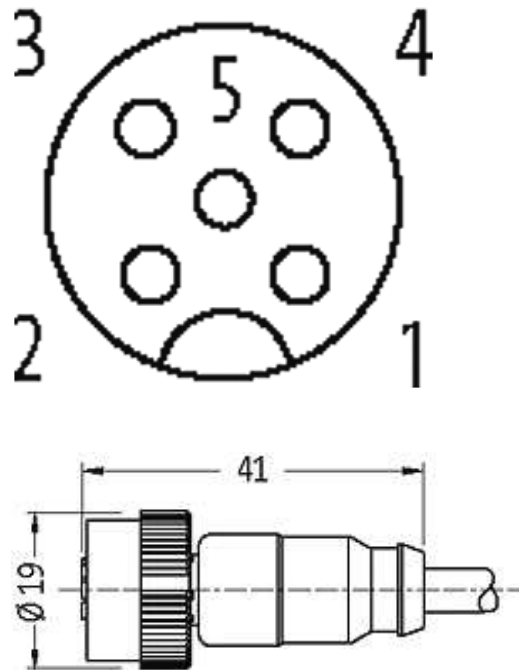

Product may differ from Image

Approvals



Form

Form 12241

Cables

Cable number	732
No./diameter of wires	5 × 0.34 mm ²
Wire isolation	PP (br, wh, bl, bk, gr)
C-track properties	5 Mio.
Torsion	2 Mio. ± 180°/m
Jacket Color	black
Shore hardness outer jacket	90 ± 5A
Material (jacket)	PUR (UL/CSA) wire color gray
Outer Ø	approx. 5.0 mm
Bend radius (fixed)	5 × outer Ø
Bend radius (moving)	10 × outer Ø
Temperature range (fixed)	-40...+80 °C

Temperature range (mobile) -25...+80 °C

General data

Temperature range -25...+85 °C, depending on cable quality

Technical Data

Operating voltage max. 125 V AC/DC

Operating current per contact max. 4 A

Locking of ports Quick connection, 1/4 turn

Protection IP67 inserted and tightened (EN 60529)

Commercial data

country of origin DE

customs tariff number 85444290

minimum order quantity 1