

**MQ12 FEMALE 90° LED**

PUR 4X0.34 YELLOW, UL/CSA, drag ch 1.5m

MQ12

Female 90°

4-pole with 3 × LED (PNP)

Further cable lengths on request. Plastic housings with good resistance against chemicals and oils. The resistance to aggressive media should be individually tested for your application. Further details on request.

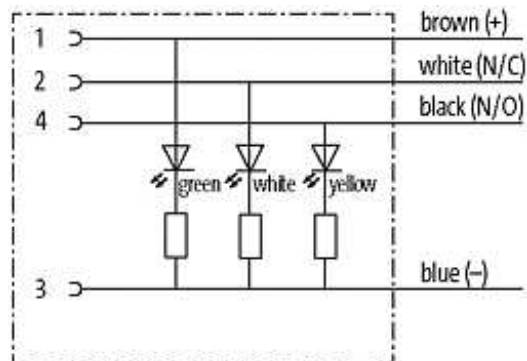
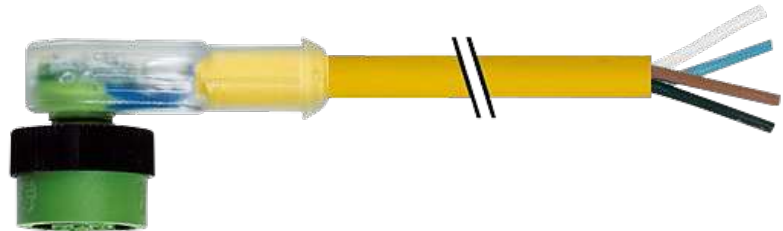
[Link to Product](#)**Illustration**

# Female

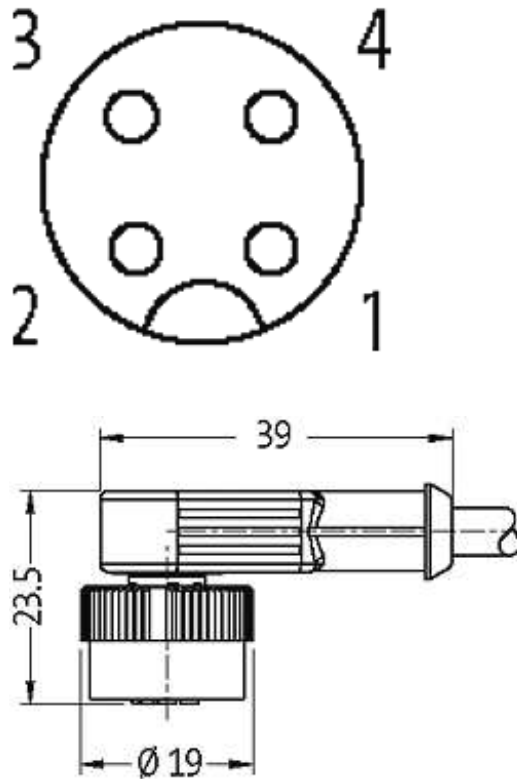

Product may differ from Image

## Approvals



## Form

Form 12421

## Cables

Cable number	034
No./diameter of wires	4 × 0.34 mm <sup>2</sup>
Wire isolation	PP (br, wh, bl, bk)
C-track properties	5 Mio.
Torsion	2 Mio. ± 180°/m
Jacket Color	yellow
Shore hardness outer jacket	90 ± 5A
Material (jacket)	PUR (UL/CSA)
Outer Ø	approx. 4.7 mm
Bend radius (fixed)	5 × outer Ø

Bend radius (moving)	10 × outer Ø
Temperature range (fixed)	-40...+80 °C
Temperature range (mobile)	-25...+80 °C

**General data**

Temperature range	-25...+85 °C, depending on cable quality
-------------------	--

**Technical Data**

Operating voltage	24 V DC ±25 %
Operating current per contact	max. 4 A
Locking of ports	Quick connection, 1/4 turn
Protection	IP67 inserted and tightened (EN 60529)

**Commercial data**

country of origin	DE
customs tariff number	85444290
minimum order quantity	1