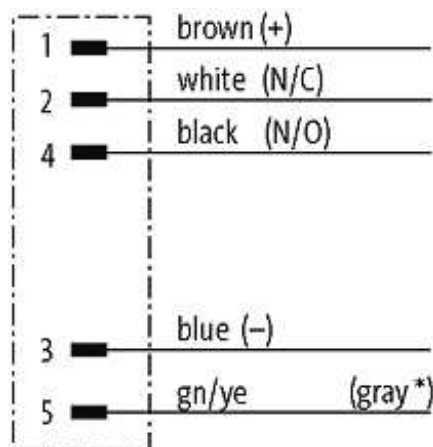

M12 male 0° with cable

TPE 5xAWG18 ye UL/CSA+drag chain 3m

M12
Male straight
5-pole
USA

Plastic housings with good resistance against chemicals and oils. The resistance to aggressive media should be individually tested for your application. Further details on request. Further cable lengths on request.

[Link to Product](#)**Illustration**

(* for cable type 162)

Male

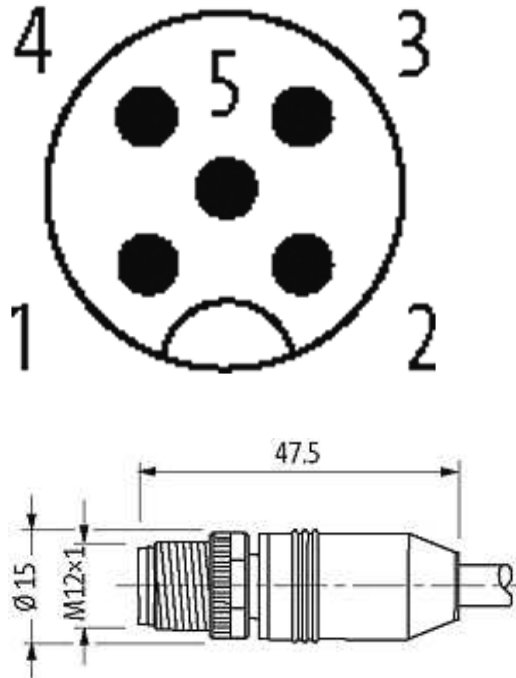

Product may differ from Image

Approvals



Form

Form 12041

Cables

Cable number	161
No./diameter of wires	5 × AWG18
Wire isolation	PVC (br, wh, bl, bk, gnye)
C-track properties	2 Mio.
Jacket Color	yellow
Shore hardness outer jacket	90 ± 5A
Material (jacket)	TPE (UL, CSA, ITC, PLTC)
Outer Ø	approx. 7.2 mm
Bend radius (fixed)	10 × outer Ø
Bend radius (moving)	15 × outer Ø
Temperature range (fixed)	-40...+105 °C
Temperature range (mobile)	-20...+105 °C

The information in this brochure has been compiled with the utmost care.

Liability for the correctness completeness and topicality of the information is restricted to gross negligence. Version: 05/16

Technical Data

Operating voltage	max. 125 V AC/DC
Operating current per contact	max. 4 A
Coding	M12, A-coded
Locking of ports	Screw thread M12 × 1 mm (recommended torque 0.6 Nm) self-securing
Compression gland	M12 (SW13)
Protection	IP66K, IP67 inserted and tightened (EN 60529)
Locking material	Zinc die casting, matte nickel plated
Material	PUR

Commercial data

country of origin	DE
customs tariff number	85444290
minimum order quantity	1