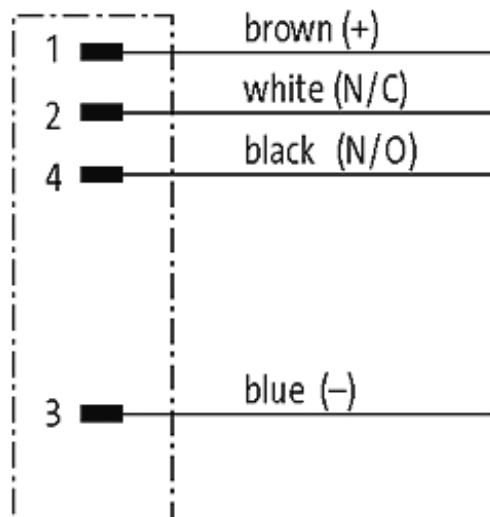
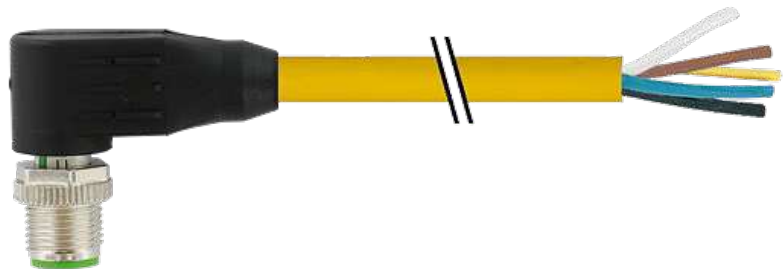

M12 male 90° with cable

TPE 4xAWG18/41 ye UL,CSA+drag chain 3m

M12
Male 90°
4-pole
USA

Plastic housings with good resistance against chemicals and oils. The resistance to aggressive media should be individually tested for your application. Further details on request. Further cable lengths on request.

[Link to Product](#)**Illustration**

Male

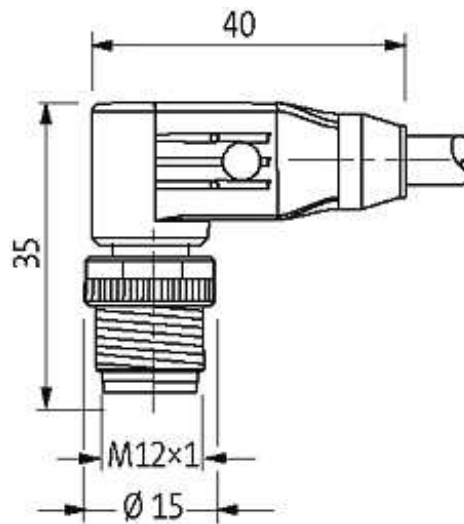

Product may differ from Image

Approvals



Form

Form 12101

Cables

Cable number	150
No./diameter of wires	4 × AWG18
Wire isolation	PVC (br, wh, bl, bk)
C-track properties	2 Mio.
Jacket Color	yellow
Shore hardness outer jacket	90 ± 5A

The information in this brochure has been compiled with the utmost care.

Liability for the correctness completeness and topicality of the information is restricted to gross negligence. Version: 05/16

Material (jacket)	TPE (UL, CSA, ITC, PLTC)
Outer Ø	approx. 6.6 mm
Bend radius (fixed)	10 × outer Ø
Bend radius (moving)	15 × outer Ø
Temperature range (fixed)	-40...+105 °C
Temperature range (mobile)	-20...+105 °C

Technical Data

Operating voltage	max. 250 V AC/DC
Operating current per contact	max. 4 A
Locking of ports	Screw thread M12 × 1 mm (recommended torque 0.6 Nm) self-securing
Locking material	Zinc die casting, matte nickel plated
Protection	IP66K, IP67 inserted and tightened (EN 60529)

Commercial data

country of origin	DE
customs tariff number	85444290
minimum order quantity	1