

**M12 male 0° D-cod. shielded with cable EN**

TPE 2x2xAWG22 shielded gn UL/CSA+drag chain 7.5m

Ethernet CAT5

M12

Male straight

D-coded, 4-pole, shielded

Further cable lengths on request. Plastic housings with good resistance against chemicals and oils. The resistance to aggressive media should be individually tested for your application. Further details on request.

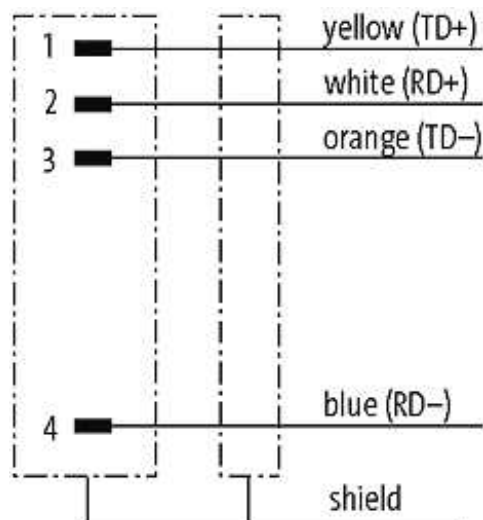
[Link to Product](#)**Illustration**

# Male

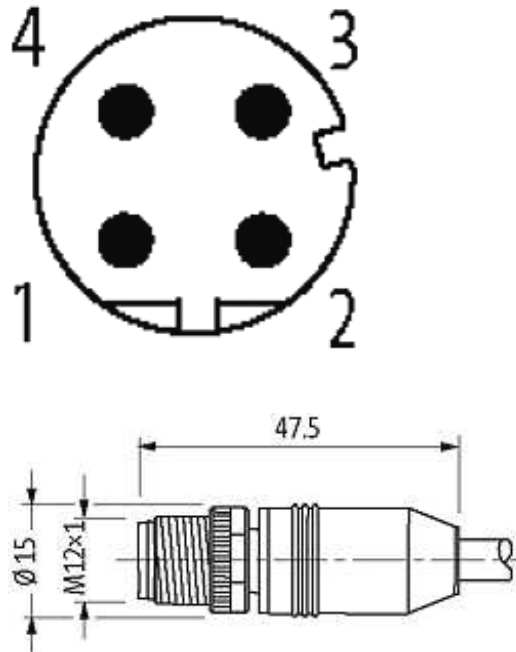

Product may differ from Image

## Approvals

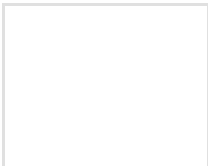

## More Info



## Form

Form 14541

## Cables

Cable number	S7V
No./diameter of wires	2 × 2 × AWG22
Wire isolation	HDPE (wh, ye, bl, or)
C-track properties	1 Mio.
Torsion	3 Mio.
Jacket Color	green
Shore hardness outer jacket	80 ± 5A
Material (jacket)	TPE (UL, CSA, ITC, PLTC)

The information in this brochure has been compiled with the utmost care.

Liability for the correctness completeness and topicality of the information is restricted to gross negligence. Version: 05/16

Outer Ø	approx. 7.9 mm
Bend radius (fixed)	5 × outer Ø
Bend radius (moving)	10 × outer Ø
Temperature range (fixed)	-40...+80 °C
Temperature range (mobile)	-40...+80 °C
Shielded	yes

#### Technical Data

Operating voltage	max. 60 V AC/DC
Operating current per contact	max. 4 A
Transfer parameters	CAT5, class D (ISO/IEC 11801:2002), (EN 50173-1)
Transfer rate	10/100 Mbit/s full duplex
Locking of ports	Screw thread M12 × 1 mm (recommended torque 0.6 Nm) self-securing
Locking material	Zinc die casting, matte nickel plated
Protection	IP66K, IP67 inserted and tightened (EN 60529)

#### Commercial data

country of origin	DE
customs tariff number	85444290
minimum order quantity	1