

## M12 male 90° D-cod. shielded with cable EN

TPE 2x2xAWG24 shielded bl UL/CSA+drag chain 2.0m

Ethernet CAT5

M12

Male 90°

D-coded, 4-pole, shielded

Further cable lengths on request. Plastic housings with good resistance against chemicals and oils. The resistance to aggressive media should be individually tested for your application. Further details on request.

### [Link to Product](#)

#### Illustration

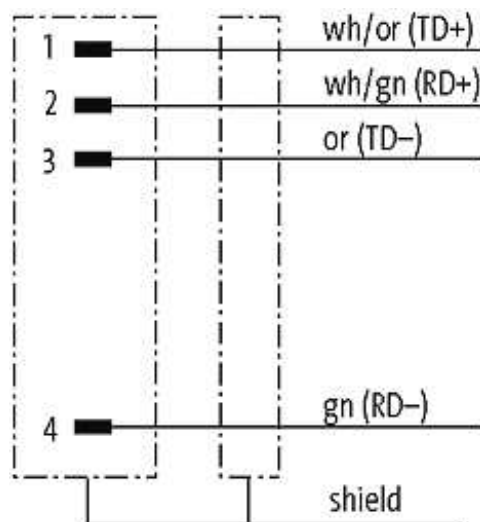

# Male

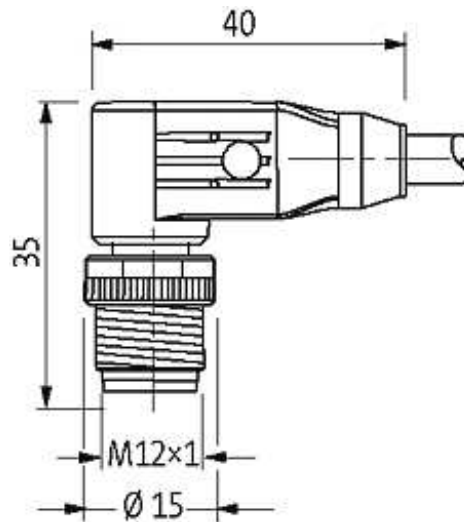

Product may differ from Image

## Approvals

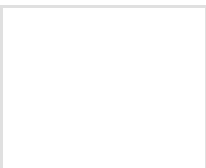

## More Info



## Form

Form 14561

## Cables

Cable number S4U

No./diameter of wires 2 × 2 × AWG24

Wire isolation	HDPE (whor, or, whgn, gn)
C-track properties	1 Mio.
Torsion	3 Mio.
Jacket Color	blue
Shore hardness outer jacket	80 ± 5A
Material (jacket)	TPE (UL, CSA, ITC, PLTC)
Outer Ø	approx. 6.6 mm
Bend radius (fixed)	5 × outer Ø
Bend radius (moving)	10 × outer Ø
Temperature range (fixed)	-40...+80 °C
Temperature range (mobile)	-40...+80 °C
Shielded	yes

### Technical Data

Operating voltage	max. 60 V AC/DC
Operating current per contact	max. 4 A
Transfer parameters	CAT5, class D (ISO/IEC 11801:2002), (EN 50173-1)
Transfer rate	10/100 Mbit/s full duplex
Locking of ports	Screw thread M12 × 1 mm (recommended torque 0.6 Nm) self-securing
Compression gland	M12 (SW13)
Protection	IP66K, IP67 inserted and tightened (EN 60529)
Locking material	Zinc die casting, matte nickel plated
Material	PUR

### Commercial data

country of origin	DE
customs tariff number	85444290
minimum order quantity	1