

M12 male 90° 8p. shielded with cable EN

TPE 4x2xAWG24 shielded bl UL/CSA+drag chain 0.6m

M12
USA
8-pole
Male 90°

Plastic housings with good resistance against chemicals and oils. The resistance to aggressive media should be individually tested for your application. Further details on request. Further cable lengths on request.

[Link to Product](#)

Illustration

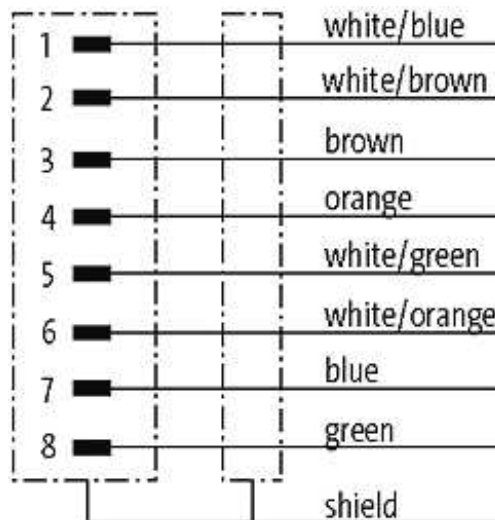
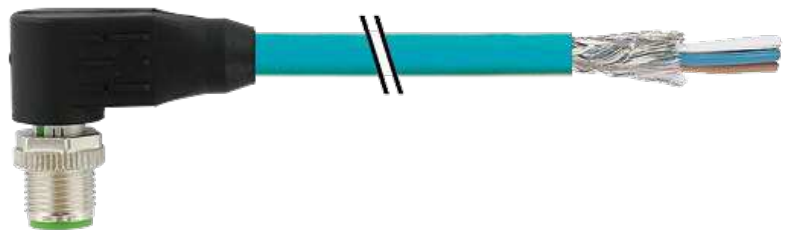

Male

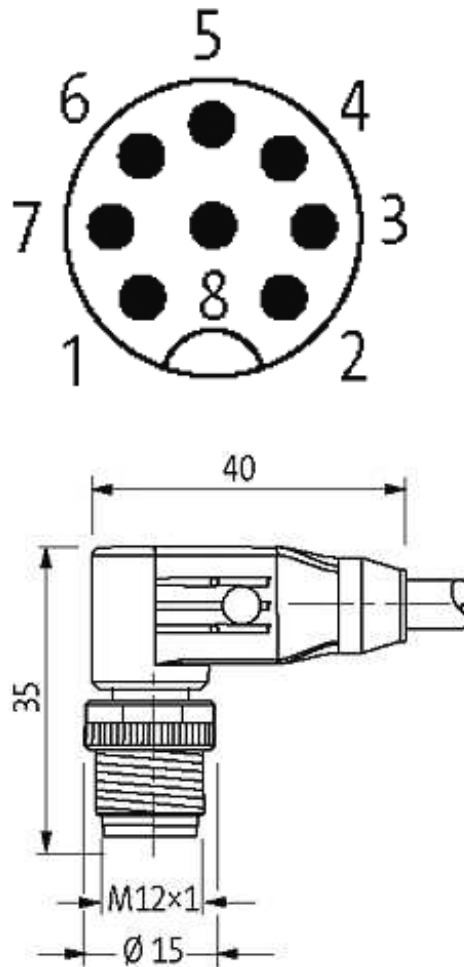

Product may differ from Image

Approvals

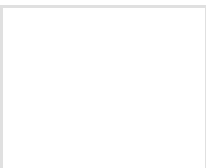

More Info



Form

Form 17561

Cables

Cable number S4W

No./diameter of wires 4 × 2 × AWG 24

Wire isolation	HDPE (whbl, bl, whor, or, whgn, gn, whbr, br)
C-track properties	1 Mio.
Torsion	3 Mio.
Jacket Color	blue
Shore hardness outer jacket	80 ± 5A
Material (jacket)	TPE (UL/CSA)
Outer Ø	approx. 7.6 mm
Bend radius (fixed)	5 × outer Ø
Bend radius (moving)	10 × outer Ø
Temperature range (fixed)	-40...+80 °C
Temperature range (mobile)	-40...+80 °C
Shielded	yes

General data

Temperature range	-25...+85 °C, depending on cable quality
-------------------	--

Technical Data

Operating voltage	30 V AC/DC
Operating current per contact	max. 2 A
Transfer parameters	CAT5, class D (ISO/IEC 11801:2002), (EN 50173-1)
Transfer rate	to 100 Mbit/s Full Duplex
Coding	M12, A-coded
Locking of ports	Screw thread M12 × 1 mm (recommended torque 0.6 Nm) self-securing
Compression gland	M12 (SW13)
Protection	IP66K, IP67 inserted and tightened (EN 60529)
Locking material	Zinc die casting, matte nickel plated
Material	PUR

Commercial data

country of origin	DE
customs tariff number	85444290
minimum order quantity	1