

M8 female 0° with cable

PVC 4x0.34 bk UL/CSA 2m

M8

Female straight

4-pole

Plastic housings with good resistance against chemicals and oils. The resistance to aggressive media should be individually tested for your application. Further details on request. Further cable lengths on request.

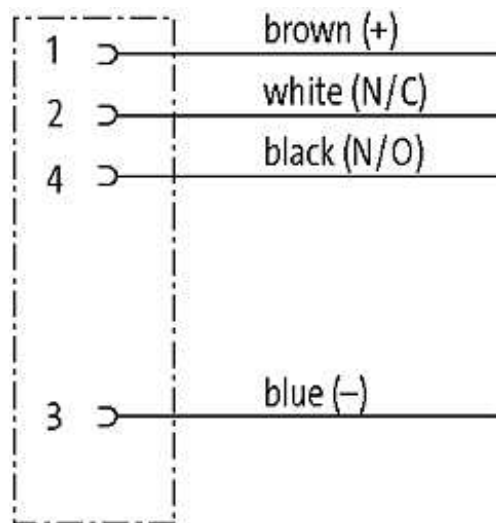
[Link to Product](#)**Illustration**

Female

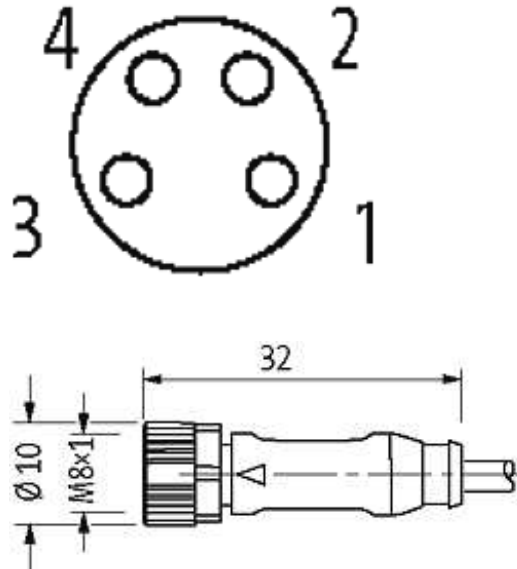

Product may differ from Image

Approvals



Form

Form 08061

Cables

Cable number	614
No./diameter of wires	4 × 0.34 mm ²
Wire isolation	PVC (br, wh, bl, bk)
Jacket Color	black
Shore hardness outer jacket	85 ± 5A
Material (jacket)	PVC (UL/CSA)
Outer Ø	approx. 5.0 mm
Bend radius (fixed)	5 × outer Ø
Bend radius (moving)	10 × outer Ø
Temperature range (fixed)	-30...+80 °C
Temperature range (mobile)	-5...+80 °C

Technical Data

Operating voltage max. 30 V AC/DC

Operating current per contact	max. 4 A
Locking of ports	Screw thread M8 × 1 mm (recommended torque 0.4 Nm) self-securing
Protection	IP66K, IP67 inserted and tightened (EN 60529)

Commercial data

country of origin	DE
customs tariff number	85444290
minimum order quantity	100