

**M8 FEMALE 90°**

PVC 3X0.34 black UL/CSA 10m

M8  
Female 90°  
3-pole

Plastic housings with good resistance against chemicals and oils. The resistance to aggressive media should be individually tested for your application. Further details on request. Further cable lengths on request.

[Link to Product](#)**Illustration**

# Female

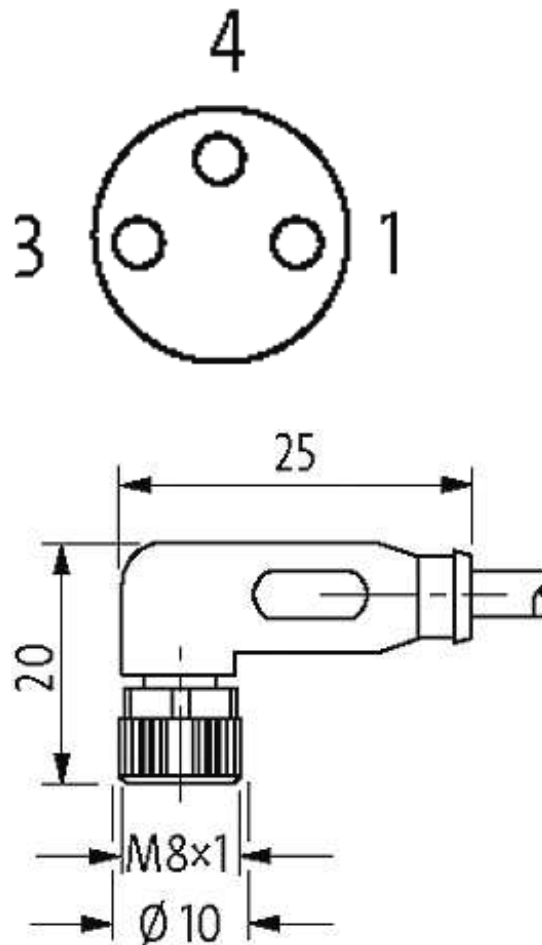

Product may differ from Image

## Approvals



## Form

Form 08081

## Cables

Cable number	613
No./diameter of wires	3 × 0.34 mm <sup>2</sup>
Wire isolation	PVC (br, bl, bk)
Jacket Color	black
Shore hardness outer jacket	85 ± 5A
Material (jacket)	PVC (UL/CSA)
Outer Ø	approx. 4.6 mm

The information in this brochure has been compiled with the utmost care.

Liability for the correctness completeness and topicality of the information is restricted to gross negligence. Version: 05/16

Bend radius (fixed)	5 × outer Ø
Bend radius (moving)	10 × outer Ø
Temperature range (fixed)	-30...+80 °C
Temperature range (mobile)	-5...+80 °C

#### Technical Data

Operating voltage	max. 60 V AC/DC
Operating current per contact	max. 4 A
Locking of ports	Screw thread M8 × 1 mm (recommended torque 0.4 Nm) self-securing
Protection	IP66K, IP67 inserted and tightened (EN 60529)

#### Commercial data

country of origin	DE
customs tariff number	85444290
minimum order quantity	100