

M8 FEMALE 90°

PUR 3X0.34 GRAY, UL/CSA, drag ch 3m

M8

Female 90°

3-pole with 2 × LED (PNP)

Plastic housings with good resistance against chemicals and oils. The resistance to aggressive media should be individually tested for your application. Further details on request. Further cable lengths on request.

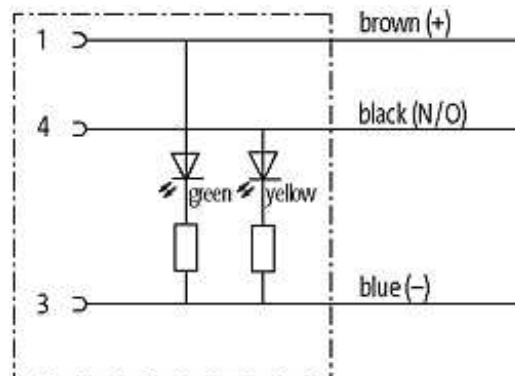
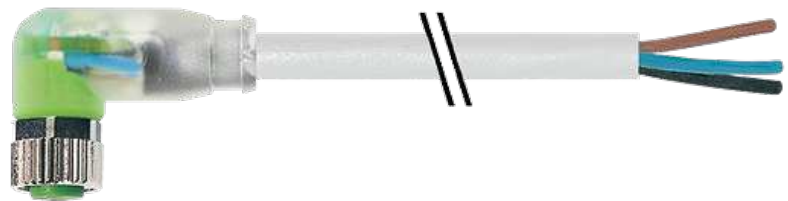
[Link to Product](#)**Illustration**

Female

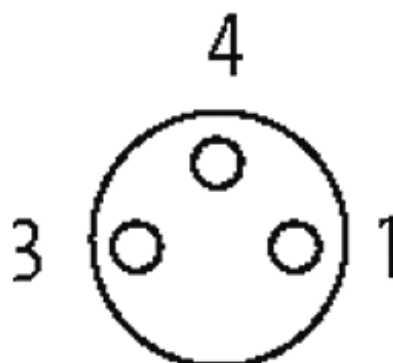

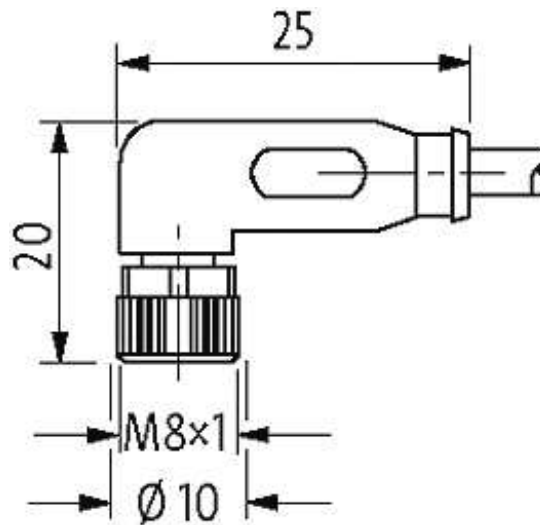

Product may differ from Image

Approvals

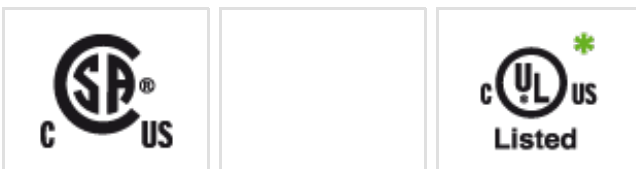

* only for products with UL/CSA approved cable

Form

Form 08121

Cables

Cable number	233
No./diameter of wires	3 × 0.34 mm ²
Wire isolation	PP (br, bl, bk)
C-track properties	5 Mio.
Torsion	2 Mio. ± 180°/m
Jacket Color	gray
Shore hardness outer jacket	90 ± 5A
Material (jacket)	PUR (UL/CSA)
Outer Ø	approx. 4.3 mm
Bend radius (fixed)	5 × outer Ø
Bend radius (moving)	10 × outer Ø
Temperature range (fixed)	-40...+80 °C
Temperature range (mobile)	-25...+80 °C

Technical Data

Operating voltage	24 V DC ±25 %
Operating current per contact	max. 4 A

Locking of ports	Screw thread M8 × 1 mm (recommended torque 0.4 Nm) self-securing
------------------	--

Protection	IP66K, IP67 inserted and tightened (EN 60529)
------------	---

Commercial data

country of origin	DE
-------------------	----

customs tariff number	85444290
-----------------------	----------

minimum order quantity	100
------------------------	-----