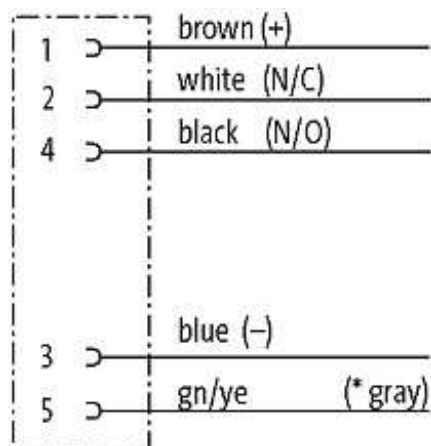

M12 FEMALE 0°

PUR 5X0.75 black UL/CSA, drag ch 5m

M12
Female straight
5-pole

Plastic housings with good resistance against chemicals and oils. The resistance to aggressive media should be individually tested for your application. Further details on request. Further cable lengths on request.

[Link to Product](#)**Illustration**

(* for cable type 126, 732, 219, 619)

Female

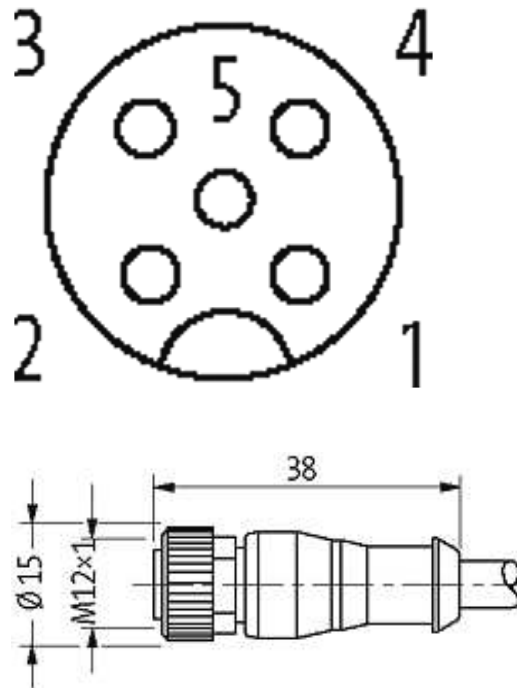

Product may differ from Image

Approvals



Form

Form 12241

Cables

Cable number	638
No./diameter of wires	5 × 0.75 mm ²
Wire isolation	PP (bk num, gnye)
C-track properties	5 Mio.
Torsion	2 Mio. ± 180°/m
Jacket Color	black
Shore hardness outer jacket	90 ± 5A
Material (jacket)	PUR (UL/CSA)
Outer Ø	approx. 7.0 mm
Bend radius (fixed)	5 × outer Ø
Bend radius (moving)	10 × outer Ø
Temperature range (fixed)	-40...+80 °C

The information in this brochure has been compiled with the utmost care.

Liability for the correctness completeness and topicality of the information is restricted to gross negligence. Version: 05/16

Temperature range (mobile) -25...+80 °C

General data

Temperature range -25...+85 °C, depending on cable quality

Technical Data

Operating voltage max. 125 V AC/DC

Operating current per contact max. 4 A

Locking of ports Screw thread M12 × 1 mm (recommended torque 0.6 Nm) self-securing

Protection IP66K, IP67 inserted and tightened (EN 60529)

Commercial data

country of origin DE

customs tariff number 85444290

minimum order quantity 100