

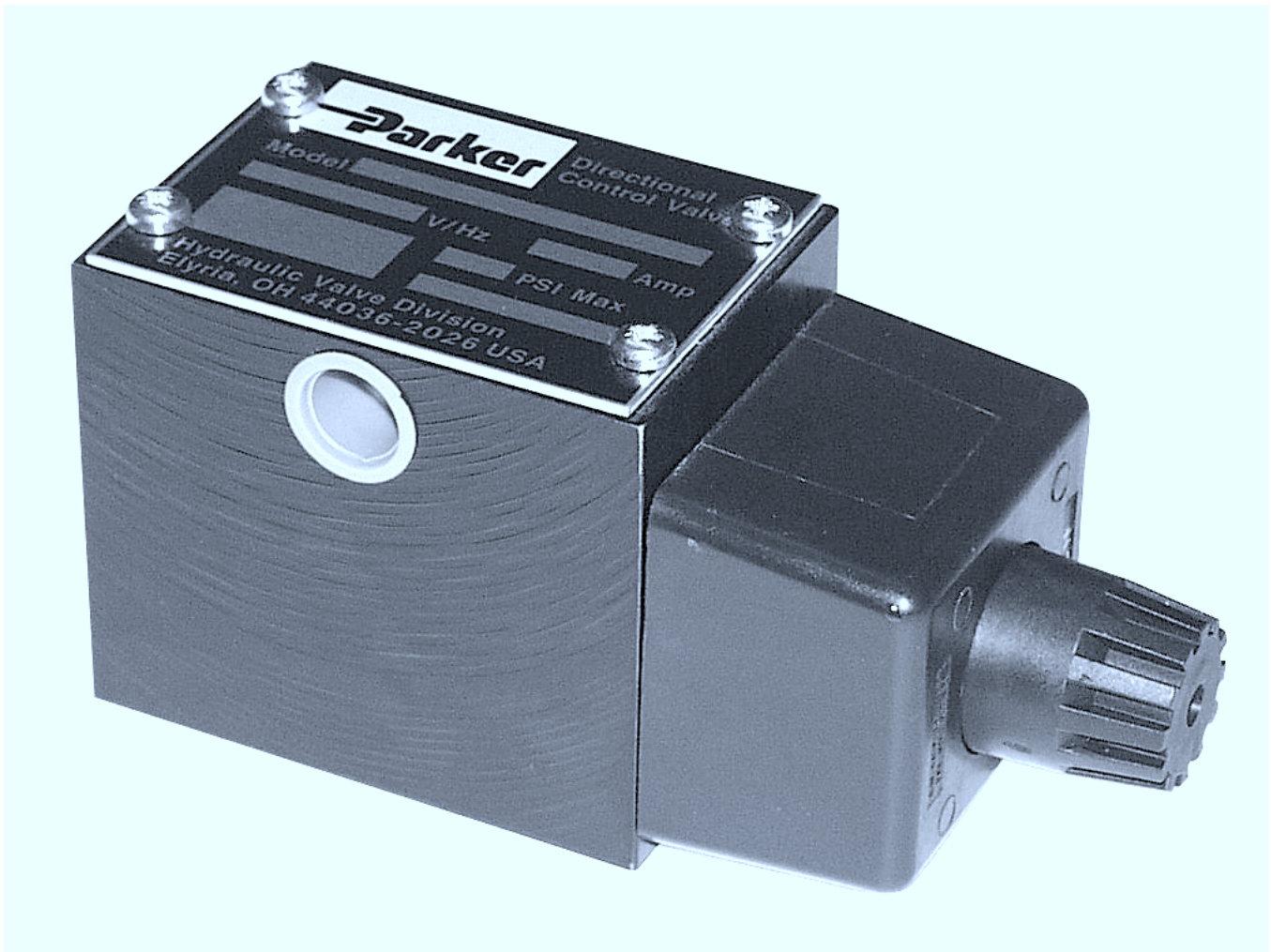

Bulletin 2542-M12/USA
Service Bulletin
Series D3W, E Style

Effective: January 1, 2000



 **WARNING**

FAILURE OR IMPROPER SELECTION OR IMPROPER USE OF THE PRODUCTS AND/OR SYSTEMS DESCRIBED HEREIN OR RELATED ITEMS CAN CAUSE DEATH, PERSONAL INJURY AND PROPERTY DAMAGE.

This document and other information from Parker Hannifin Corporation, its subsidiaries and authorized distributors provide product and/or system options for further investigation by users having technical expertise. It is important that you analyze all aspects of your application and review the information concerning the product or system in the current product catalog. Due to the variety of operating conditions and applications for these products or systems, the user, through its own analysis and testing, is solely responsible for making the final selection of the products and systems and assuring that all performance, safety and warning requirements of the application are met.

The products described herein, including without limitation, product features, specifications, designs, availability and pricing, are subject to change by Parker Hannifin Corporation and its subsidiaries at any time without notice.

Offer of Sale

The items described in this document are hereby offered for sale by Parker Hannifin Corporation, its subsidiaries or its authorized distributors. This offer and its acceptance are governed by the provisions stated in the "Offer of Sale".

© Copyright 2000, Parker Hannifin Corporation, All Rights Reserved

2542-M12.p65, dd, am

Contents

Ordering Information	1-2
Parts Data	3-7
D3W**E**C**	3
D3W**E**K**	4
D3W**E**P**, D3DW**E**W**	5
D3W**E**S*	6
D3W**E**E**	7
Technical Information	8-13
Spool Chart	12
Troubleshooting Guide	14-15
Offer of Sale	16

D

Directional Control Valve

3

Basic Valve

W

Actuator

Spool

E

Style

Seal

Seal

Solenoid Voltage

Solenoid Voltage

Connector Package

Connector Package

NFPA D05
 CETOP 5
 NG 10

Wet armature
 solenoid

Code	Description
N	Nitrile
V	Fluorocarbon

Code	Description
E	24/60 - 24/50 VAC
Y *	120/60 - 110/50 VAC
T *	240/60 - 220/50 VAC
K #	12 VDC
J #	24 VDC
D	120 VDC
Z	250 VDC

* Available in low watt version with integral rectifier.
 # Low Watt Coil available.

Code	Symbol	Code	Symbol
1		10†	
2		11	
3		12	
4		16	
5		21†	
6		22†	
7		81†	
8*, 9**		82†	

* 8 spool has closed crossover
 ** 9 spool has open crossover
 † Available only with rectified AC coils or high watt DC coils

Code	Description
E	Single solenoid, 2 position, spring offset to center. P to B and A to T when energized.

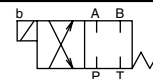

This condition varies with spool code

Code	Description
C	Conduit Cavity
K	Conduit Adaptor
P	Hirschmann w/Plug
W*	Hirschmann w/o Plug
S	Double Spade
E	Explosion Proof

*Not available with signal lights.

Ordering Information

Directional Control Valves Series D3W, E Style

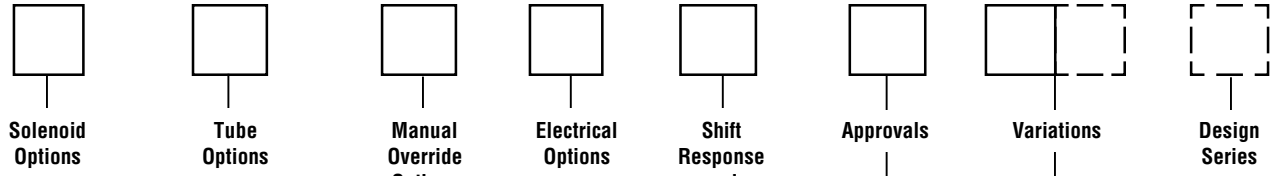

Solenoid Options

Code	Coil
Omit	High Watt
D†	Explosion Proof, EExd
F	Low Watt
U	Explosion Proof, UL/CSA

† Explosion proof coils are 60 Hz at standard voltage; dual rating not available.

Tube Options

Code	Description
Omit	Low Pressure

Manual Override Options

Code	Description
Omit	Standard Tube
P	Extended Manual Override
R	Repairable Manual Override

Electrical Options

Code	Description
Omit	No Option
V	Varistor Surge Suppressor
Z	AC Rectified Coil

Code	Description
Omit	Standard Response
S4	Soft Shift, 0.040" Orifice
S7†	Soft Shift, 0.070" Orifice
I7	Monitor Switch*

* Single solenoid models only. Not CE or CSA approved.
† Recommended for spools 3, 4, 15.

Shift Response and Indication

Approvals

Code	Description
Omit	Standard Valve
4	CSA Approval
K	UL Recognition

Variations

Code	Description
Omit	Standard Valve
5	Signal Lights
6	Manaplug, Brad Harrison Mini
7	Manaplug, Brad Harrison Micro (M12x1)
56	Manaplug (Mini) with Lights
57	Manaplug (Micro) with Lights (M12x1)
1A	Manaplug (Mini) Single Sol. 5-Pin
1B	Manaplug (Micro) Single Sol. 5-Pin (M12x1)
1C	Manaplug (Mini) Single Sol. 5-Pin w/Lights
1D	Manaplug (Micro) Single Sol. 5-Pin w/Lights (M12x1)

Design Series

NOTE:
Not required when ordering.

Valve Weight:	
Single Solenoid:	
AC	4.3 kg (9.5 lbs)
DC	5.3 kg (11.6 lbs)
Standard Bolt Kit:	
BK98	

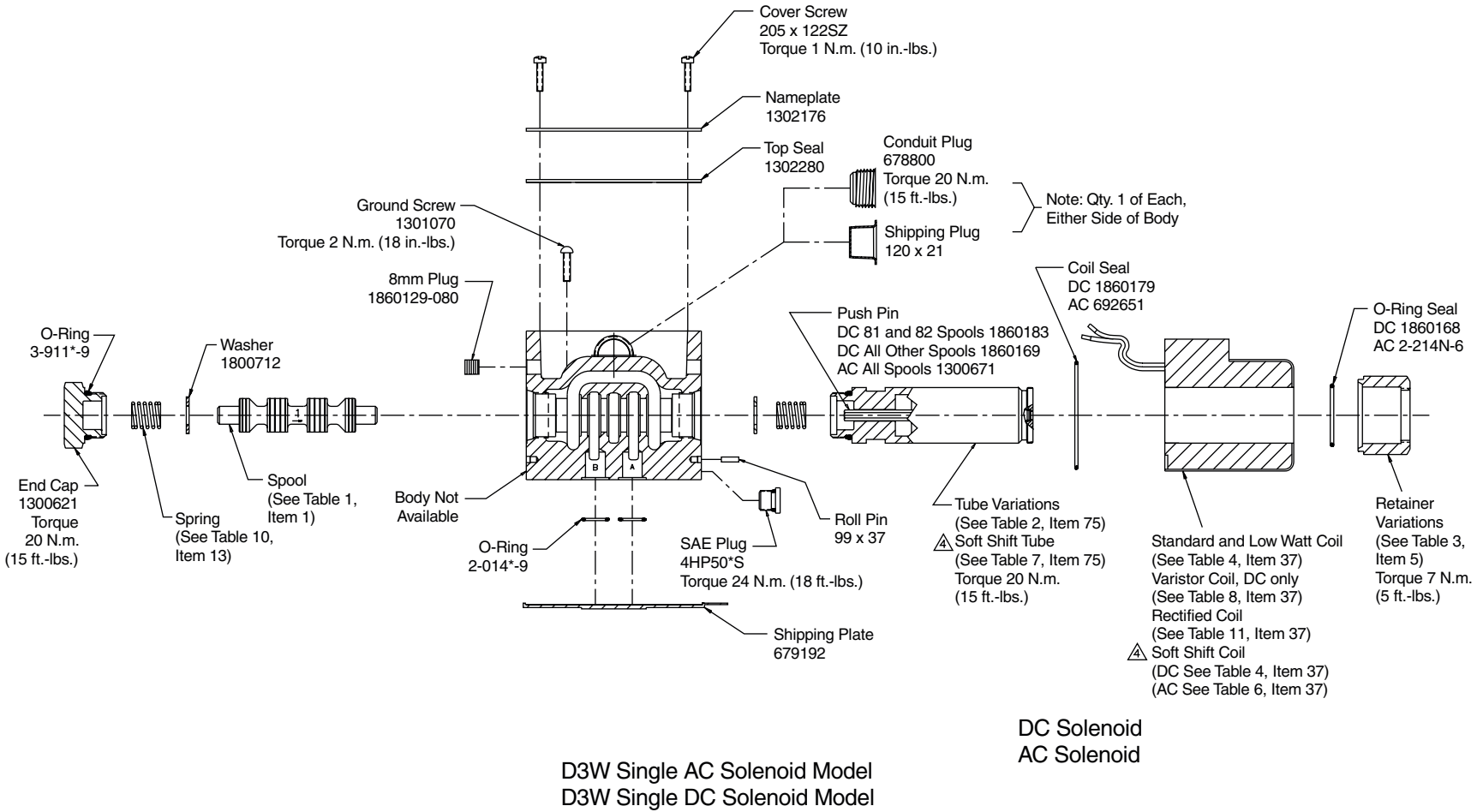

NOTES:

- 1) DC Components Shown, See Tables for AC Components Where Applicable
- 2) * Indicates Seal Compound: N-Nitrile, V-Fluorocarbon.
- 3) Gasket 1300698 (Used on AC Only) Not Shown. Reference C-Style for Location.
- △ See Detail "A" in Tables Location.

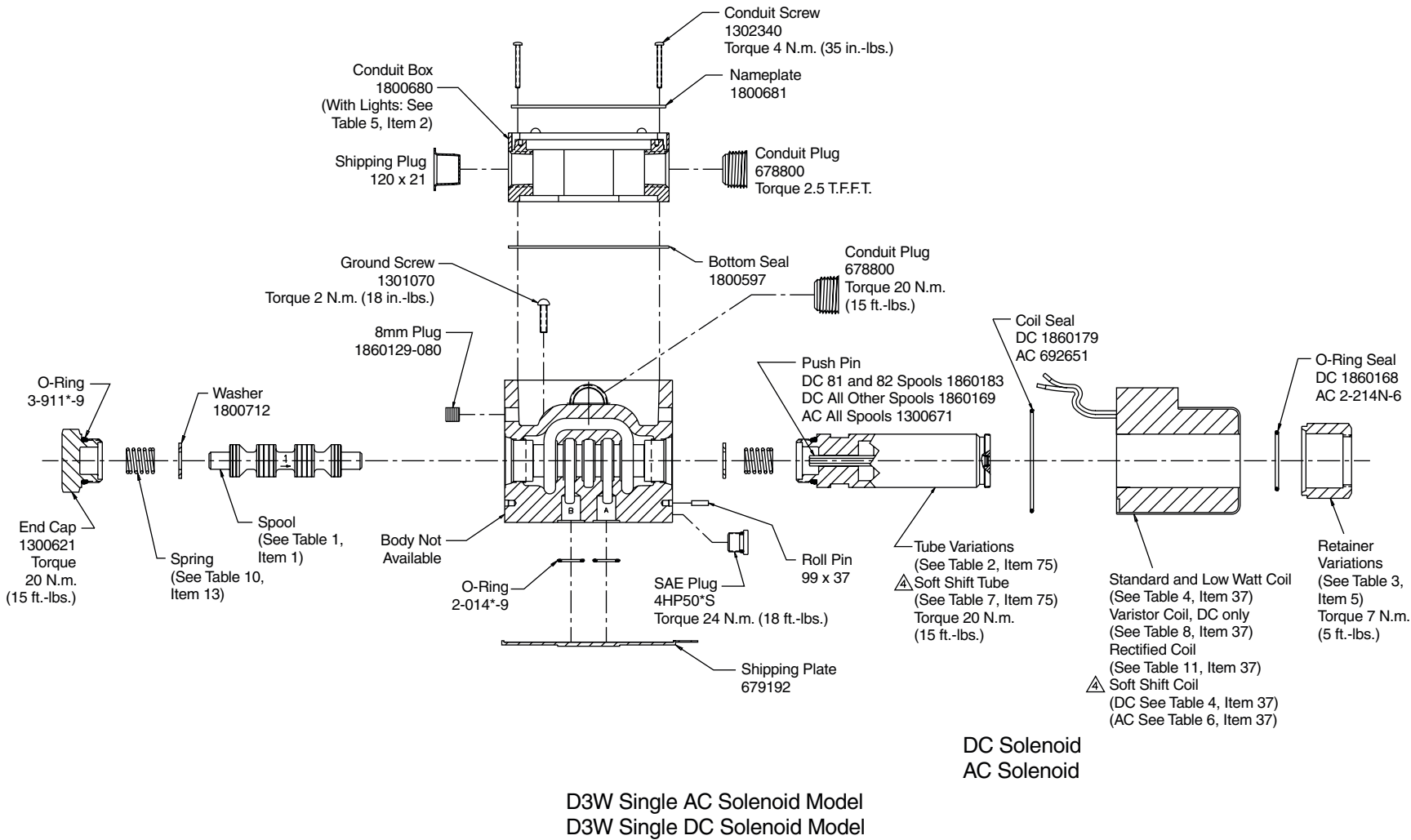

NOTES:

- 1) DC Components Shown. See Tables for AC Components Where Applicable
 - 2) * Indicates Seal Compound: N-Nitrile, V-Fluorocarbon.
 - 3) Gasket 1300698 (Used on AC Only) Not Shown. Reference C-Style for Location.
- ▲ See Detail "A" in Tables Location.

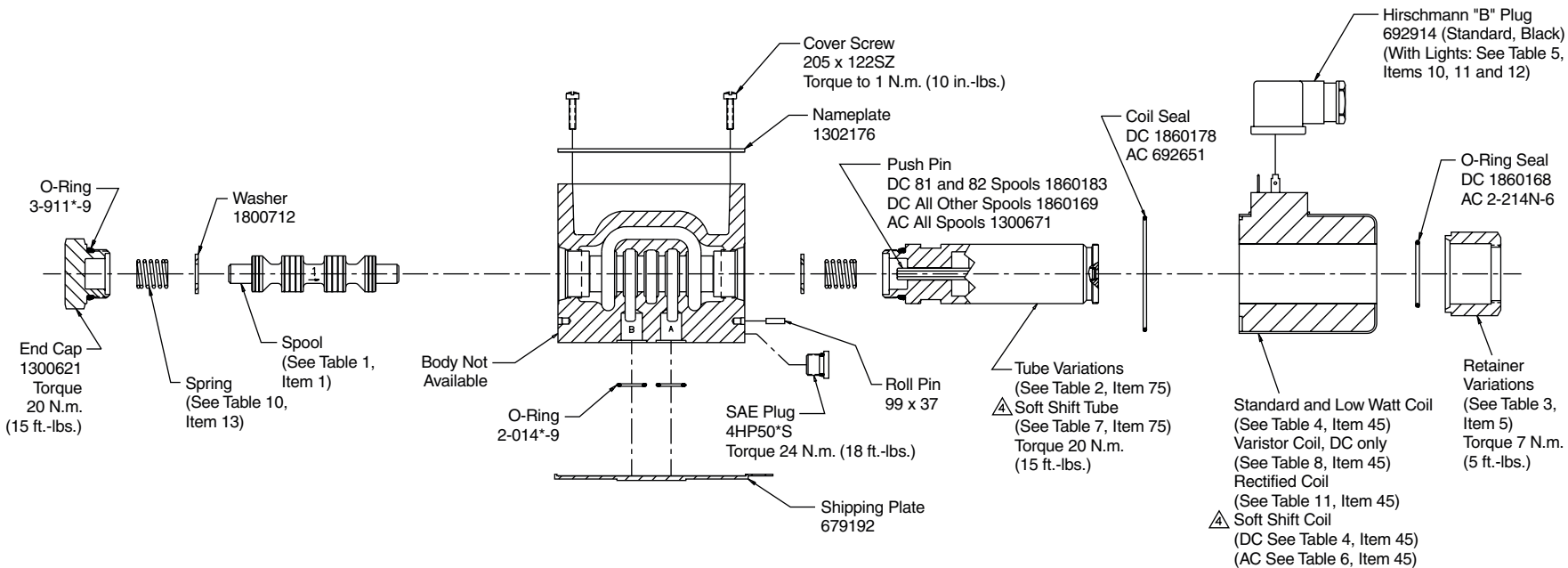

D3W Single AC Solenoid Model
 D3W Single DC Solenoid Model

DC Solenoid
 AC Solenoid

NOTES:

- 1) DC Components Shown, See Tables for AC Components Where Applicable
 - 2) * Indicates Seal Compound: N-Nitrile, V-Fluorocarbon.
 - 3) Gasket 1300698 (Used on AC Only) Not Shown. Reference C-Style for Location.
- ▲ See Detail "A" in Tables Location.

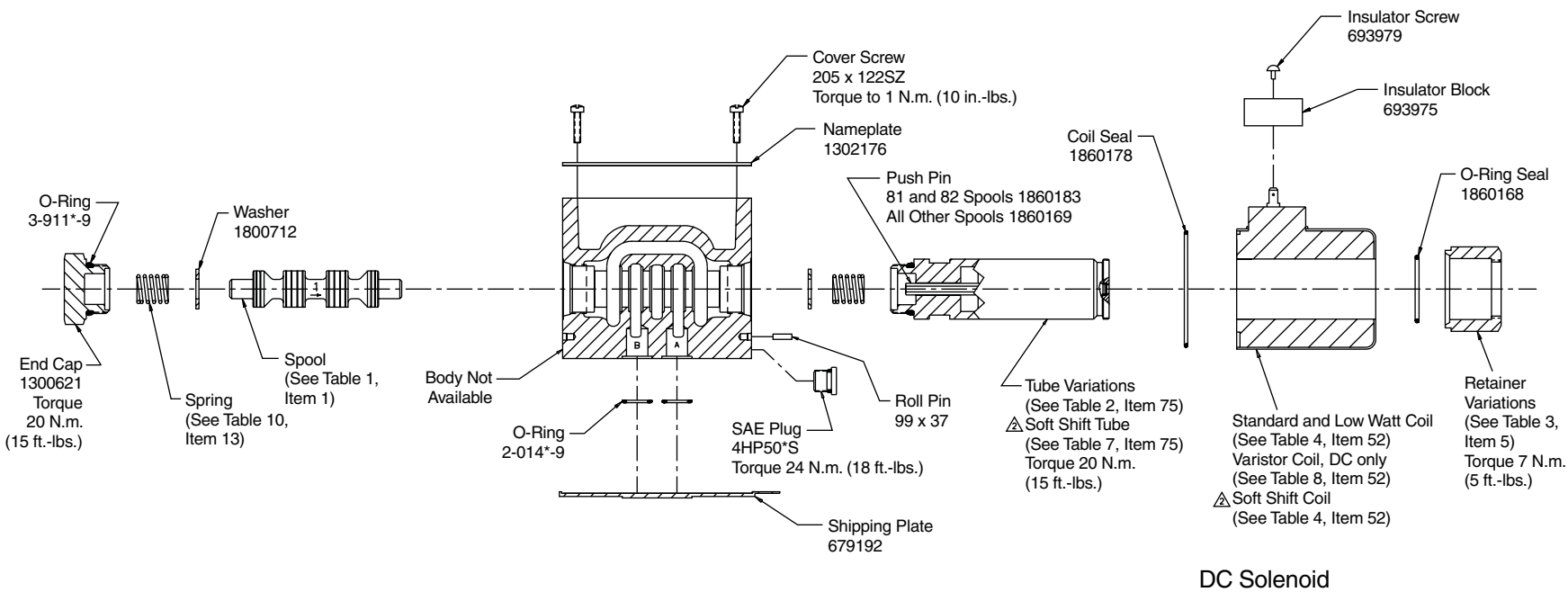

D3W Single DC Solenoid Model

DC Solenoid

NOTES:

- 1) * Indicates Seal Compound: N-Nitrile, V-Fluorocarbon.
- ▲ See Detail "A" in Tables Location.

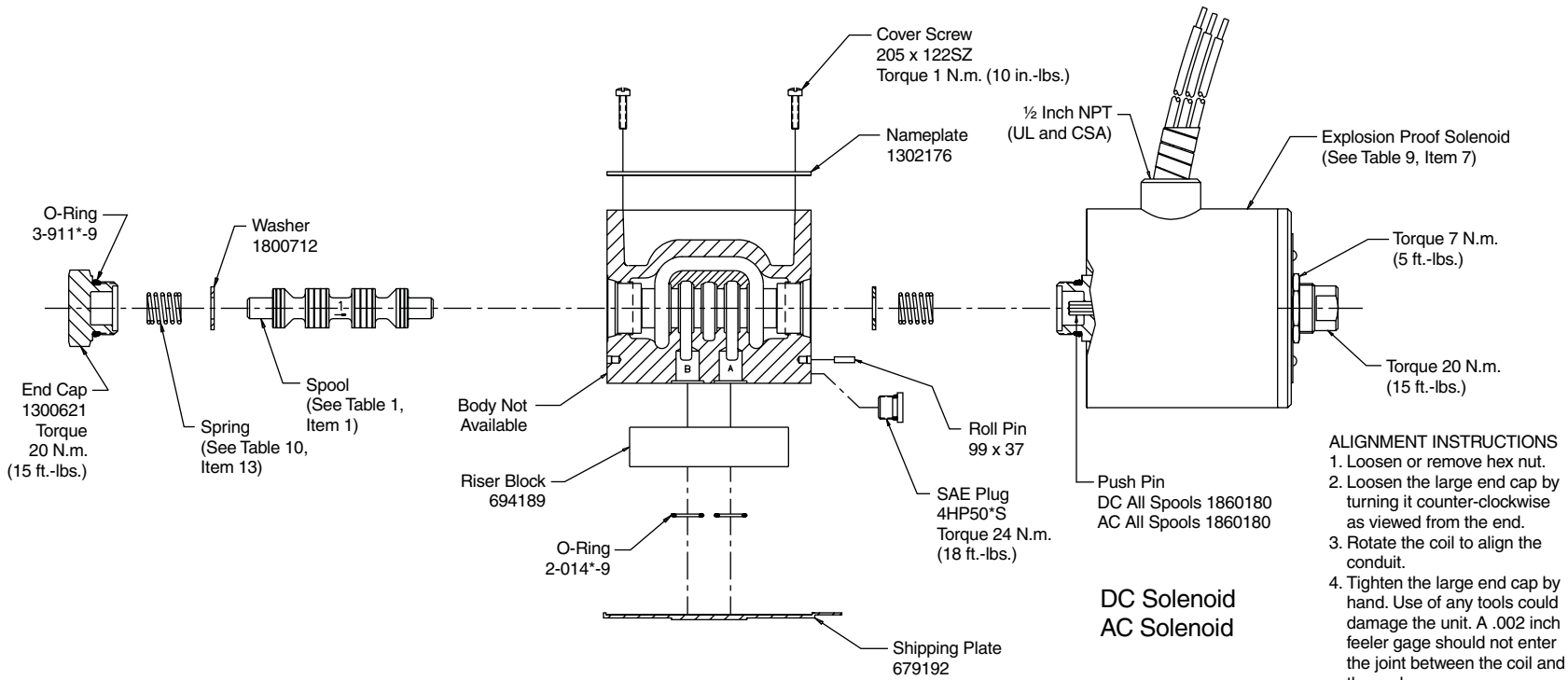

D3W Single AC Solenoid Model
 D3W Single DC Solenoid Model

ALIGNMENT INSTRUCTIONS

1. Loosen or remove hex nut.
2. Loosen the large end cap by turning it counter-clockwise as viewed from the end.
3. Rotate the coil to align the conduit.
4. Tighten the large end cap by hand. Use of any tools could damage the unit. A .002 inch feeler gage should not enter the joint between the coil and the end cap.
5. Replace the hex nut and torque to 20 N.m. (15 ft.-lbs.) maximum.

DC Solenoid
 AC Solenoid

NOTES:

- 1) DC Components Shown. See Tables for AC Components where Applicable.
- 2) * Indicates Seal Compound: N-Nitrile, V-Fluorocarbon.

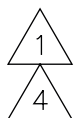

CODE	ITEM	PART NUMBER	QTY	DESCRIPTION
1	1	1300601	1	#1 SPOOL
2	1	1300602	1	#2 SPOOL
3	1	1300603	1	#3 SPOOL
4	1	1300604	1	#4 SPOOL
5	1	1300605	1	#5 SPOOL
6	1	1300606	1	#6 SPOOL
7	1	1300607	1	#7 SPOOL
8	1	1300608	1	#8 SPOOL
9	1	1300609	1	#9 SPOOL
10	1	1300610	1	#10 SPOOL
11	1	1300611	1	#11 SPOOL
12	1	1300664	1	#12 SPOOL
14	1	1300607	1	#7 SPOOL REVERSED
15	1	1300603	1	#3 SPOOL REVERSED
16	1	1300605	1	#5 SPOOL REVERSED
21	1	1301701	1	#21 SPOOL
22	1	1301701	1	#21 SPOOL REVERSED
81	1	1210161	1	#81 SPOOL
82	1	1210162	1	#82 SPOOL



NOTES:

- 1 ARROW POINTS TOWARD "A" PORT FOR ALL SPOOLS EXCEPT 14,15, 16 AND 22.
- 2 FOR "E" AND "K" STYLES WITH 8 OR 9 SPOOLS, SOLENOID IS ON OPPOSITE END OF THAT SHOWN IN ILLUSTRATION.
- 3 81 AND 82 SPOOLS NOT APPLICABLE WITH EXPLOSION PROOF OPTIONS.
- 4 10,21,22,81 AND 82 SPOOLS ONLY AVAILABLE IN RECTIFIED AC OR HIGH WATT DC ONLY.

CODE	ITEM	PART NUMBER	QTY	DESCRIPTION
OMIT or F	75	1300666	A/R	A.C. TUBE 1500 PSI
		1860163		D.C. TUBE 1500 PSI
P or FP	75	1860174	A/R	EXTENDED A.C. TUBE 1500 PSI
		1860165		EXTENDED D.C. TUBE 1500 PSI
R or FR	75	1860175	A/R	REPAIRABLE A.C. TUBE 1500 PSI
		1860166		REPAIRABLE D.C. TUBE 1500 PSI

CODE	ITEM	PART NUMBER	QTY	DESCRIPTION
ALL EXCEPT R,S,P & T	5	693568	A/R	AC STANDARD RETAINER
		1860167		DC STANDARD RETAINER
P or FP HP or FHP	5	1300128	A/R	AC EXT. OVERRIDE RETAINER
		1860171		DC EXT. OVERRIDE RETAINER
		697161		EXTENDED OVERRIDE BOOT
ALL R ALL S	5	1300700	A/R	AC REPAIR. OVERRIDE RETAINER
		1860167		DC REPAIR. OVERRIDE RETAINER
ALL T	5	693568	A/R	AC STANDARD RETAINER
		1300812		TAMPERPROOF DISC (AC ONLY)
		1300532		TAMPERPROOF DISC (AC ONLY)
		1860182		DC TAMPERPROOF RETAINER

		C	P/W	S
SOL CONNECTION		(CONDUIT)	(HIRSCHMANN)	(DUAL SPADE)
ITEM		37	45	52

CODE	DESCRIPTION	QTY	PART NUMBER	PART NUMBER	PART NUMBER
E*	24/50-24/60 VAC, 32/36 WATT	A/R	691745-1	1300574	N/A
Y*	120/60-110/50 VAC, 32 WATT	A/R	691740-1	691750	N/A
T*	240/60-220/50 VAC, 32 WATT	A/R	691743-1	693987	N/A
K*	12 VDC, 36 WATT	A/R	1860156-K	1860152-K	1860160-K
K*F	12 VDC, 18 WATT (LOW WATT)	A/R	1860157-K	1860153-K	1860161-K
J*	24 VDC, 36 WATT	A/R	1860156-J	1860152-J	1860160-J
J*F	24 VDC, 18 WATT (LOW WATT)	A/R	1860157-J	1860153-J	1860161-J
D*	120 VDC	A/R	1860156-D	1860152-D	1860160-D
Z*	250 VDC	A/R	1860156-Z	1860152-Z	1860160-Z

Table 5 (Signal Lights)

CODE	ITEM	PART NUMBER	QTY	DESCRIPTION	CODE	ITEM	PART NUMBER	QTY	DESCRIPTION
ALL PLUGS (*P*5)	10	A697047	A/R	LABEL - "A" SOLENOID	YK*5	2	1800679-Y	1	CONDUIT BOX COVER, 120VAC
	11	A697048	A/R	LABEL - "B" SOLENOID	TK*5		1800679-T	1	CONDUIT BOX COVER, 240VAC
					EK*5		1800679-E	1	CONDUIT BOX COVER, 24VAC
YP*5		B694936	A/R	PLUG WITH LIGHT, 100-120V	KK*5		1800679-K	1	CONDUIT BOX COVER, 12VDC
TP*5		B694936	A/R	PLUG WITH LIGHT, 240V	JK*5		1800679-J	1	CONDUIT BOX COVER, 24VDC
KP*5	12	B694935	A/R	PLUG WITH LIGHT, 12V	DK*5		1800679-D	1	CONDUIT BOX COVER, 120VDC
JP*5		B694935	A/R	PLUG WITH LIGHT, 24V	ZK*5		1800679-Z	1	CONDUIT BOX COVER, 250VDC
DP*5		B694936	A/R	PLUG WITH LIGHT, 100-120V			697799	1	WARNING LABEL

Table 6 (Soft Shift Coils, AC Only)

		SOL CONNECTION	C/K (CONDUIT)	P/W (HIRSCHMANN)
		ITEM	37	45
CODE	DESCRIPTION	QTY	PART NUMBER	PART NUMBER
E*	24/50-24/60 VAC, 32/36 WATT	A/R	1860158-E	1860154-E
Y*	120/60-110/50 VAC, 32 WATT	A/R	1860158-Y	1860154-Y
T*	240/60-220/50 VAC, 32 WATT	A/R	1860158-T	1860154-T

Table 7 (Soft Shift Tubes, AC or DC)

CODE	ITEM	PART NUMBER	QTY	DESCRIPTION
S4	75	1860172-4	A/R	AC 1500 PSI SOFT SHIFT TUBE
S7	75	1860172-7	A/R	AC 1500 PSI SOFT SHIFT TUBE
RS4	75	1860164	A/R	AC 1500 PSI REPAIRABLE SOFT SHIFT TUBE
		1301663	A/R	.040 ORIFICE
RS7		1860164	A/R	AC 1500 PSI REPAIRABLE SOFT SHIFT TUBE
		1800748	A/R	.070 ORIFICE

Table 8 (Varistor Coils, DC Only)

		SOL CONNECTION	C/K (CONDUIT)	P/W (HIRSCHMANN)	S (DUAL SPADE)
		ITEM	37	45	52
CODE	DESCRIPTION	QTY	PART NUMBER	PART NUMBER	PART NUMBER
K*	12 VDC	A/R	1860159-K	1860155-K	1860162-K
J*	24 VDC	A/R	1860159-J	1860155-J	1860162-J
D*	120 VDC	A/R	1860159-D	1860155-D	1860162-D
Z*	250 VDC	A/R	1860159-Z	1860155-Z	1860162-Z

Table 9 (Explosion Proof Coils)

Table 9 (Explosion Proof Coils)				
SOL CONNECTION			D (CENELEC)	U (UL & CSA)
ITEM			7	7
CODE	DESCRIPTION	QTY	PART NUMBER	PART NUMBER
YE	120/60 VAC	A/R	1302310-Y	132308-Y
TE	240/60 VAC	A/R	1302310-T	132308-T
PE	110/50 VAC	A/R	1302310-P	132308-P
NE	220/50 VAC	A/R	1302310-N	132308-N
KE	12 VDC	A/R	1302310-K	132308-K
JE	24 VDC	A/R	1302310-J	132308-J
DE	120 VDC	A/R	1302310-D	132308-D
ZE	250 VDC	A/R	1302310-Z	132308-Z

Table 10 (Springs)

CODE	ITEM	PART NUMBER	QTY	DESCRIPTION
ALL EXCEPT F	13	1301262	2	AC SPRING FOR SPOOLS 1,2,3,4,5,6,11,12,15,16
		1301263		AC SPRING FOR SPOOLS 7,8,9,14
ALL EXCEPT F	13	1800683	2	DC SPRING FOR SPOOLS 1,3,4,5,6,10,11,15,16,21,81,82
		1800684		DC SPRING FOR SPOOLS 2,7,8,9,12,14
F	13	1800685	2	DC LOW WATT SPRING FOR SPOOLS 1,3,4,5,6,11,15,16
		1800686		DC LOW WATT SPRING FOR SPOOLS 2,7,8,9,12,14

Table 11 (Rectified Coils, AC Only)

Table 11 (Rectified Coils, AC Only)				
SOL CONNECTION			C/K (CONDUIT)	P/W (HIRSCHMANN)
ITEM			37	45
CODE	DESCRIPTION	QTY	PART NUMBER	PART NUMBER
E*	24/50-24/60 VAC, 32/36 WATT	A/R	1860158-E	1860154-E
Y*	120/60-110/50 VAC, 32 WATT	A/R	1860158-Y	1860154-Y
T*	240/60-220/50 VAC, 32 WATT	A/R	1860158-T	1860154-T

Detail A: Repairable Soft Shift Option
 (Codes "RS4" and "RS7")

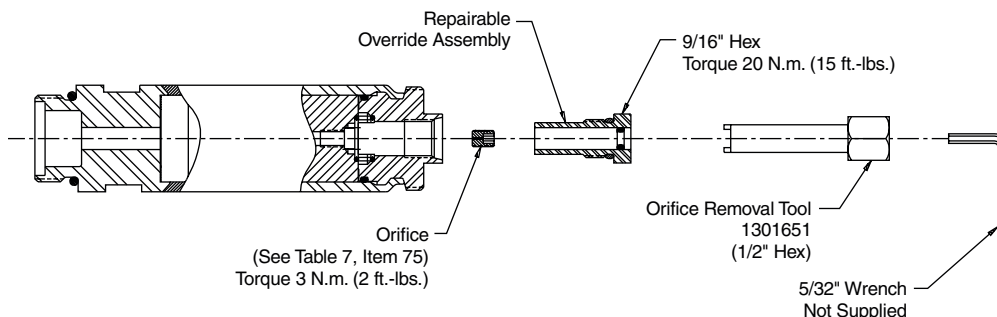

Solenoid Ratings**

Insulation	Class H
Allowable Deviation from rated voltage	-10% to +15%
Armature	Wet pin type

** DC Solenoids available with optional molded metal oxide varistor (MOV) for surge suppression.
 Leadwire length 6" from coil face.

D3W**F Solenoid Electrical Characteristics†**

Solenoid Code	Nominal Volts/Hz	In Rush Amps	Holding Amps	Watts
KF	12 VDC	—	3.00	18
JF	24 VDC	—	0.75	18

† Based on nominal voltage @ 22°C (72°F)

D3W Solenoid Electrical Characteristics†

Solenoid Code	Nominal Volts/Hz	In Rush VA	Holding VA	Nominal Watts (Ref)
Y	120/60	298	95	32
	110/50	294	102	
T	240/60	288	96	32
	220/50	288	101	
E	24/60	290	77	32
	24/50	381	110	
K	12 VDC	—	3.00†	36
J	24 VDC	—	1.50†	36
D	120 VDC	—	0.30†	36
Z	250 VDC	—	0.14†	36

† DC holding amps.

Explosion Proof Solenoids

Explosion Proof Solenoid Ratings

U.L. (EU) C.S.A.	Class I, Div. 1 & 2, Groups C & D Class II, Div 1 & 2, Groups E, F & G As defined by the N.E.C
CENELEC (ED)	Complies with BASEEFA requirements for BS5501: Parts 1 and 5 Ex'd CENELEC EN50 – D18, Group II B

Electrical Characteristics* ED and EU

Solenoid Code	Nominal Volts/Hz	In Rush VA	Holding VA	Nominal Watts (Ref)
Y	120/60	266	82	36
T	240/60	266	82	36
K	12 VDC	—	3.00†	36
J	24 VDC	—	1.50†	36
D	120 VDC	—	0.30†	36
Z	250 VDC	—	0.14†	36

*Dual frequency not available on explosion proof coils.

† DC holding amps.

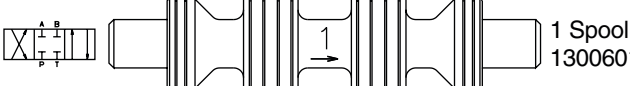
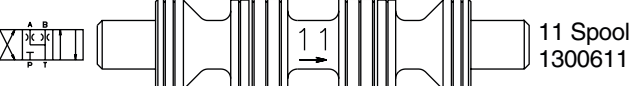
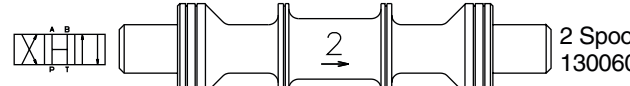
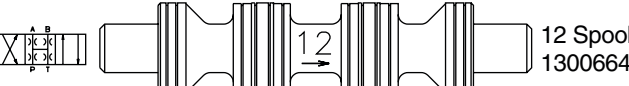
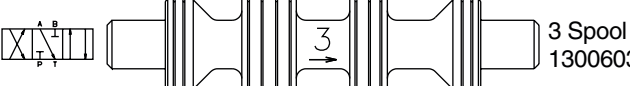
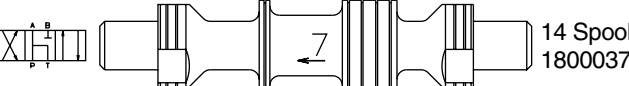
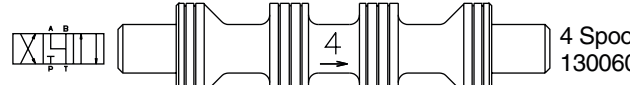
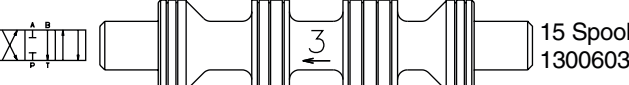
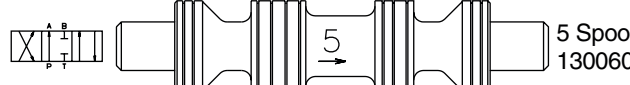
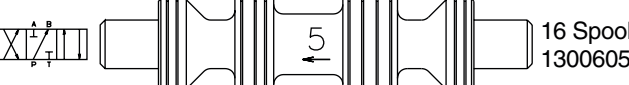
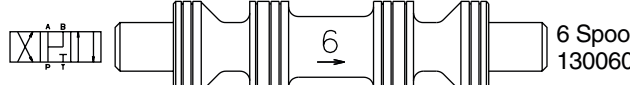
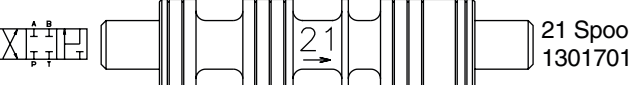
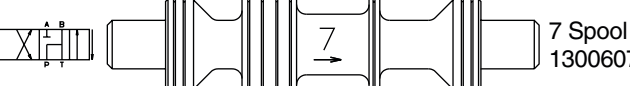
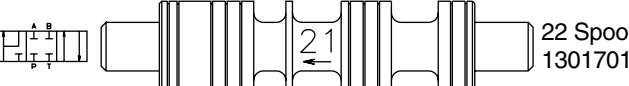
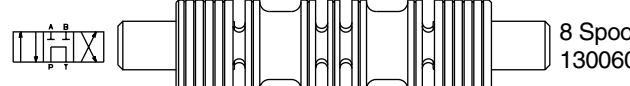
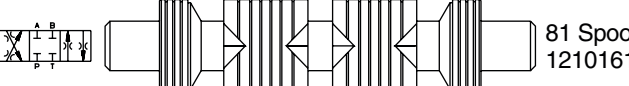
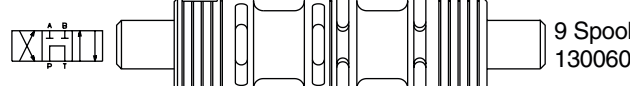
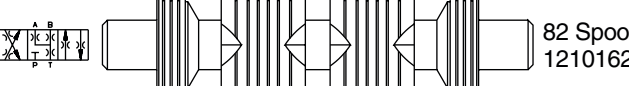
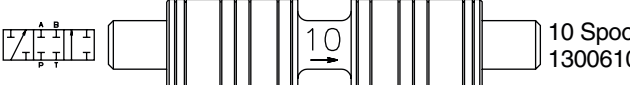
<p>B-SOLENOID *(A-SOLENOID)</p>	<p>B-SOLENOID *(A-SOLENOID)</p>
 <p>1 Spool 1300601</p>	 <p>11 Spool 1300611</p>
 <p>2 Spool 1300602</p>	 <p>12 Spool 1300664</p>
 <p>3 Spool 1300603</p>	 <p>14 Spool 1800037</p>
 <p>4 Spool 1300604</p>	 <p>15 Spool 1300603</p>
 <p>5 Spool 1300605</p>	 <p>16 Spool 1300605</p>
 <p>6 Spool 1300606</p>	 <p>21 Spool 1301701</p>
 <p>7 Spool 1300607</p>	 <p>22 Spool 1301701</p>
 <p>8 Spool* 1300608</p>	 <p>81 Spool 1210161</p>
 <p>9 Spool** 1300609</p>	 <p>82 Spool 1210162</p>
 <p>10 Spool 1300610</p>	

* 8 spool has closed crossover

** 9 spool has open crossover

Soft Shift with Tool

Repairable Soft Shift Tool

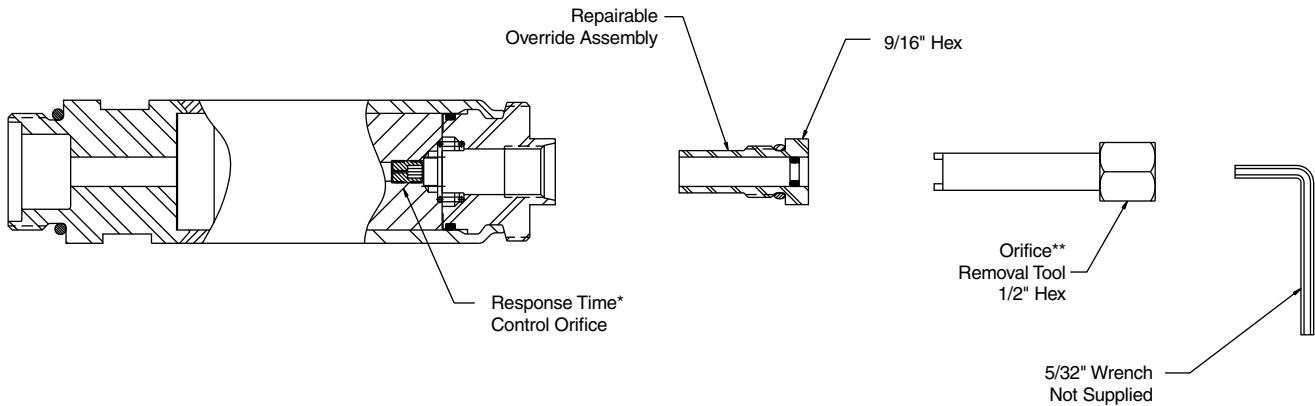

** Orifice Removal Tool with Kit Part Number 1301661

Single Solenoid AC

Inch equivalents for millimeter dimensions are shown in (**)

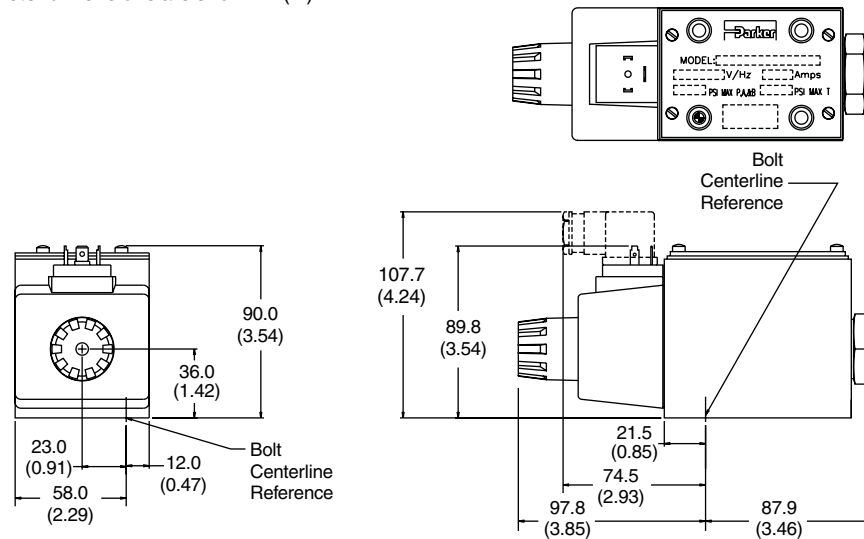

Single Solenoid DC

Inch equivalents for millimeter dimensions are shown in (**)

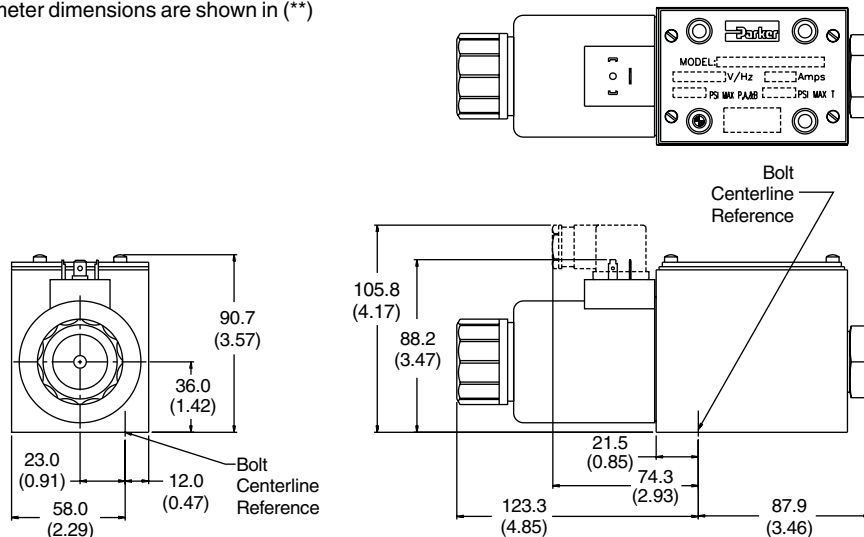

Warning

Before any circuit connection is broken, be sure to turn off all power and relieve system pressure. Lower all vertical loads and cylinders, lock any load which could produce pressure and discharge any accumulators. Plug and cap all lines and openings to prevent contamination from entering the system.

Cleaning and Inspection

1. Proper cleaning is a critical part of preventive maintenance in the use of directional control valves. All parts should be cleaned with a solvent that is compatible with the system fluid. Compressed air may also work well when cleaning orifices and passage ways, but proper filtration must be employed to remove water and contamination.

NOTE: Always make sure all parts have been cleaned before reassembling.

2. Inspection

a. Inspect all passage ways for obstructions.

b. Inspect all washers, push pins, plungers and pole faces for signs of wear and/or mushrooming. Inspect all springs for signs of distortion. Replace parts as necessary.

c. Look for nicks and burrs on the spool and bore lands. Nicks in these areas indicate likely contamination of the system fluid.

3. If there are no signs of nicks or burrs on the spool and bore, check the spool movement as follows:

a. Lubricate the spool and bore with clean system fluid.

b. Insert the spool back into the body and slowly move the spool back and forth. The spool should move freely. If there is any sticking between the spool and the bore, remove the spool and repeat 2a, 2c and 3a.

c. The spool movement can also be checked by placing the valve body on end and inserting the spool. Gravity will pull the spool to the other end if there is no sticking.

d. After several attempts have been made without resolution, replace the valve.

Troubleshooting

Problem: Valve spool fails to move

	Cause	Recommendation
Mechanical	Recommended flow exceeded	Check maximum flow rate for appropriate spool by spool function.
	Recommended pressure exceeded	Check maximum pressure rating for valve.
	Improper installation connections	Check installation drawings.
	Contamination in system	Disassemble, inspect, clean and flush.
	Improper assembly	Check proper assembly. Refer to drawing for appropriate model.
	Valve has silted	Disassemble and clean valve.
Electrical	Power off	Turn power on.
	Improper voltage	Check voltage requirements for valve model.
	Faulty connection	Check connections.
	Faulty coil	Check coil resistance.

Problem: Valve produces undesirable response

	Cause	Recommendation
Mechanical	Recommended flow exceeded	Check maximum flow rate for appropriate spool by spool function.
	Recommended pressure exceeded	Check maximum pressure rating for valve.
	Improper installation connections	Check installation drawings.
	Contamination in system	Disassemble, inspect, clean and flush.
	Improper assembly	Check proper assembly. Refer to drawing for appropriate model.
	Improper fluid	Check fluid recommendations.
	Recommended temperature exceeded (indicated by fluid discoloration or spool tarnishing)	Check maximum temperature recommendations.
	Incorrect orifice size (soft shift only)	Check orifice size for desired response time.
Electrical	Improper voltage	Check voltage requirements for valve model.
	Faulty connection	Check connections.
	Faulty coil	Check coil resistance.

Offer of Sale

The items described in this document and other documents or descriptions provided by Parker Hannifin Corporation, its subsidiaries and its authorized distributors are hereby offered for sale at prices to be established by Parker Hannifin Corporation, its subsidiaries and its authorized distributors. This offer and its acceptance by any customer ("Buyer") shall be governed by all of the following Terms and Conditions. Buyer's order for any such items, when communicated to Parker Hannifin Corporation, its subsidiary or an authorized distributor ("Seller") verbally or in writing, shall constitute acceptance of this offer.

1. Terms and Conditions of Sale: All descriptions, quotations, proposals, offers, acknowledgments, acceptances and sales of Seller's products are subject to and shall be governed exclusively by the terms and conditions stated herein. Buyer's acceptance of any offer to sell is limited to these terms and conditions. Any terms or conditions in addition to, or inconsistent with those stated herein, proposed by Buyer in any acceptance of an offer by Seller, are hereby objected to. No such additional, different or inconsistent terms and conditions shall become part of the contract between Buyer and Seller unless expressly accepted in writing by Seller. Seller's acceptance of any offer to purchase by Buyer is expressly conditional upon Buyer's assent to all the terms and conditions stated herein, including any terms in addition to, or inconsistent with those contained in Buyer's offer. Acceptance of Seller's products shall in all events constitute such assent.

2. Payment: Payment shall be made by Buyer net 30 days from the date of delivery of the items purchased hereunder. Amounts not timely paid shall bear interest at the maximum rate permitted by law for each month or portion thereof that the Buyer is late in making payment. Any claims by Buyer for omissions or shortages in a shipment shall be waived unless Seller receives notice thereof within 30 days after Buyer's receipt of the shipment.

3. Delivery: Unless otherwise provided on the face hereof, delivery shall be made F.O.B. Seller's plant. Regardless of the method of delivery, however, risk of loss shall pass to Buyer upon Seller's delivery to a carrier. Any delivery dates shown are approximate only and Seller shall have no liability for any delays in delivery.

4. Warranty: Seller warrants that the items sold hereunder shall be free from defects in material or workmanship for a period of 18 months from date of shipment from Parker Hannifin Corporation. **THIS WARRANTY COMPRISES THE SOLE AND ENTIRE WARRANTY PERTAINING TO ITEMS PROVIDED HEREUNDER. SELLER MAKES NO OTHER WARRANTY, GUARANTEE, OR REPRESENTATION OF ANY KIND WHATSOEVER. ALL OTHER WARRANTIES, INCLUDING BUT NOT LIMITED TO, MERCHANTABILITY AND FITNESS FOR PURPOSE, WHETHER EXPRESS, IMPLIED, OR ARISING BY OPERATION OF LAW, TRADE USAGE, OR COURSE OF DEALING ARE HEREBY DISCLAIMED.**

NOTWITHSTANDING THE FOREGOING, THERE ARE NO WARRANTIES WHATSOEVER ON ITEMS BUILT OR ACQUIRED WHOLLY OR PARTIALLY, TO BUYER'S DESIGNS OR SPECIFICATIONS.

5. Limitation Of Remedy: SELLER'S LIABILITY ARISING FROM OR IN ANY WAY CONNECTED WITH THE ITEMS SOLD OR THIS CONTRACT SHALL BE LIMITED EXCLUSIVELY TO REPAIR OR REPLACEMENT OF THE ITEMS SOLD OR REFUND OF THE PURCHASE PRICE PAID BY BUYER, AT SELLER'S SOLE OPTION. IN NO EVENT SHALL SELLER BE LIABLE FOR ANY INCIDENTAL, CONSEQUENTIAL OR SPECIAL DAMAGES OF ANY KIND OR NATURE WHATSOEVER, INCLUDING BUT NOT LIMITED TO LOST PROFITS ARISING FROM OR IN ANY WAY CONNECTED WITH THIS AGREEMENT OR ITEMS SOLD HEREUNDER, WHETHER ALLEGED TO ARISE FROM BREACH OF CONTRACT, EXPRESS OR IMPLIED WARRANTY, OR IN TORT, INCLUDING WITHOUT LIMITATION, NEGLIGENCE, FAILURE TO WARN OR STRICT LIABILITY.

6. Changes, Reschedules and Cancellations: Buyer may request to modify the designs or specifications for the items sold hereunder as well as the quantities and delivery dates thereof, or may request to cancel all or part of this order, however, no such requested modification or cancellation shall become part of the contract between Buyer and Seller unless accepted by Seller in a written amendment to this Agreement. Acceptance of any such requested modification or cancellation shall be at Seller's discretion, and shall be upon such terms and conditions as Seller may require.

7. Special Tooling: A tooling charge may be imposed for any special tooling, including without limitation, dies, fixtures, molds and patterns, acquired to manufacture items sold pursuant to this contract. Such special tooling shall be and remain Seller's property notwithstanding payment of any charges by Buyer. In no event will Buyer acquire any interest in apparatus belonging to Seller which is utilized in the manufacture of the items sold hereunder, even if such apparatus has been specially converted or adapted for such manufacture and notwithstanding any charges

paid by Buyer. Unless otherwise agreed, Seller shall have the right to alter, discard or otherwise dispose of any special tooling or other property in its sole discretion at any time.

8. Buyer's Property: Any designs, tools, patterns, materials, drawings, confidential information or equipment furnished by Buyer or any other items which become Buyer's property, may be considered obsolete and may be destroyed by Seller after two (2) consecutive years have elapsed without Buyer placing an order for the items which are manufactured using such property. Seller shall not be responsible for any loss or damage to such property while it is in Seller's possession or control.

9. Taxes: Unless otherwise indicated on the face hereof, all prices and charges are exclusive of excise, sales, use, property, occupational or like taxes which may be imposed by any taxing authority upon the manufacture, sale or delivery of the items sold hereunder. If any such taxes must be paid by Seller or if Seller is liable for the collection of such tax, the amount thereof shall be in addition to the amounts for the items sold. Buyer agrees to pay all such taxes or to reimburse Seller therefore upon receipt of its invoice. If Buyer claims exemption from any sales, use or other tax imposed by any taxing authority, Buyer shall save Seller harmless from and against any such tax, together with any interest or penalties thereon which may be assessed if the items are held to be taxable.

10. Indemnity For Infringement of Intellectual Property Rights: Seller shall have no liability for infringement of any patents, trademarks, copyrights, trade dress, trade secrets or similar rights except as provided in this Part 10. Seller will defend and indemnify Buyer against allegations of infringement of U.S. Patents, U.S. Trademarks, copyrights, trade dress and trade secrets (hereinafter 'Intellectual Property Rights'). Seller will defend at its expense and will pay the cost of any settlement or damages awarded in an action brought against Buyer based on an allegation that an item sold pursuant to this contract infringes the Intellectual Property Rights of a third party. Seller's obligation to defend and indemnify Buyer is contingent on Buyer notifying Seller within ten (10) days after Buyer becomes aware of such allegations of infringement, and Seller having sole control over the defense of any allegations or actions including all negotiations for settlement or compromise. If an item sold hereunder is subject to a claim that it infringes the Intellectual Property Rights of a third party, Seller may, at its sole expense and option, procure for Buyer the right to continue using said item, replace or modify said item so as to make it noninfringing, or offer to accept return of said item and return the purchase price less a reasonable allowance for depreciation. Notwithstanding the foregoing, Seller shall have no liability for claims of infringement based on information provided by Buyer, or directed to items delivered hereunder for which the designs are specified in whole or part by Buyer, or infringements resulting from the modification, combination or use in a system of any item sold hereunder. The foregoing provisions of this Part 10 shall constitute Seller's sole and exclusive liability and Buyer's sole and exclusive remedy for infringement of Intellectual Property Rights. If a claim is based on information provided by Buyer or if the design for an item delivered hereunder is specified in whole or in part by Buyer, Buyer shall defend and indemnify Seller for all costs, expenses or judgments resulting from any claim that such item infringes any patent, trademark, copyright, trade dress, trade secret or any similar right.

11. Force Majeure: Seller does not assume the risk of and shall not be liable for delay or failure to perform any of Seller's obligations by reason of circumstances beyond the reasonable control of Seller (hereinafter 'Events of Force Majeure'). Events of Force Majeure shall include without limitation, accidents, acts of God, strikes or labor disputes, acts, laws, rules or regulations of any government or government agency, fires, floods, delays or failures in delivery of carriers or suppliers, shortages of materials and any other cause beyond Seller's control.

12. Entire Agreement/Governing Law: The terms and conditions set forth herein, together with any amendments, modifications and any different terms or conditions expressly accepted by Seller in writing, shall constitute the entire Agreement concerning the items sold, and there are no oral or other representations or agreements which pertain thereto. This Agreement shall be governed in all respects by the law of the State of Ohio. No actions arising out of the sale of the items sold hereunder or this Agreement may be brought by either party more than two (2) years after the cause of action accrues.

9/91-P



Parker Hannifin Corporation
Hydraulic Valve Division
520 Ternes Avenue
Elyria, Ohio 44035 USA
Tel: (440) 366-5200
Fax: (440) 366-5253
Web Site: <http://www.parker.com/hydraulicvalve>

Bulletin 2542-M12/USA,
5M, 1/00, PHD