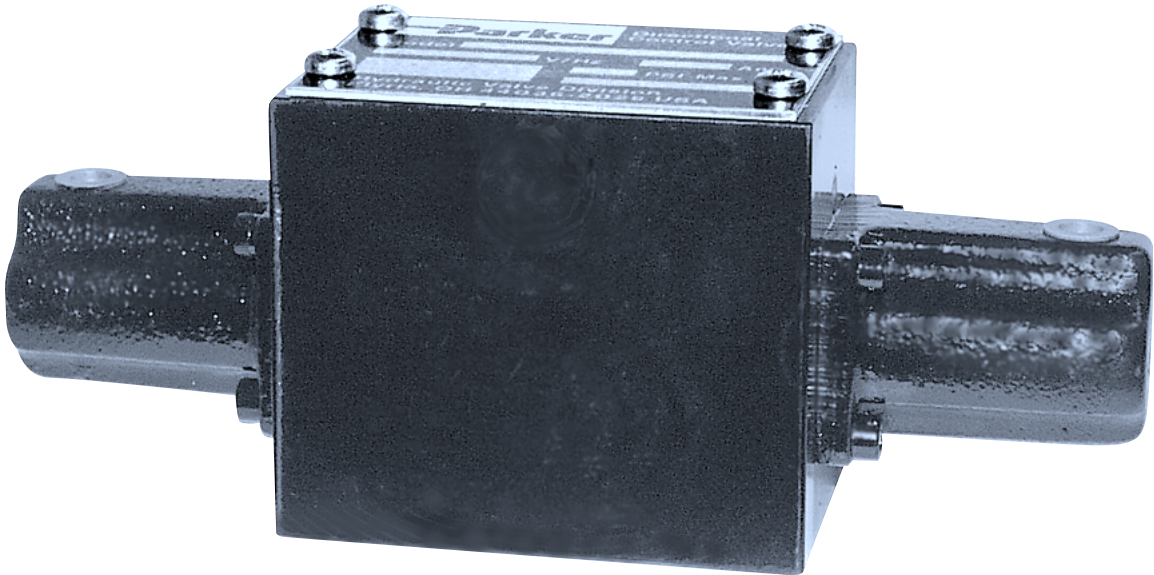




Bulletin 2542-M17/USA
Service Bulletin
Series D3A

Effective: January 1, 2000



Ordering Information 1-2

Parts Data 3-8

 D3A*B** 3

 D3A*C** 4

 D3A*D** 5

 D3A*E** 6

 D3A*H** 7

 D3A*K** 8

Spool Chart 9

Troubleshooting Guide 10

 **WARNING**

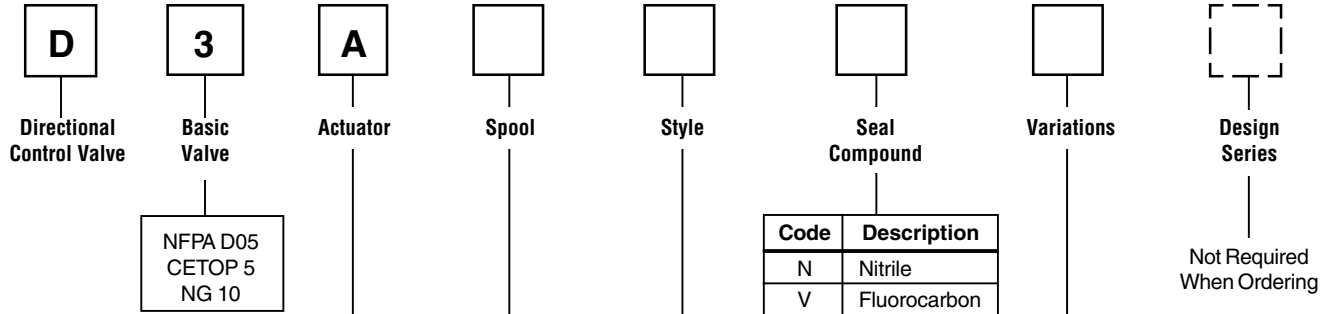
FAILURE OR IMPROPER SELECTION OR IMPROPER USE OF THE PRODUCTS AND/OR SYSTEMS DESCRIBED HEREIN OR RELATED ITEMS CAN CAUSE DEATH, PERSONAL INJURY AND PROPERTY DAMAGE.

This document and other information from Parker Hannifin Corporation, its subsidiaries and authorized distributors provide product and/or system options for further investigation by users having technical expertise. It is important that you analyze all aspects of your application and review the information concerning the product or system in the current product catalog. Due to the variety of operating conditions and applications for these products or systems, the user, through its own analysis and testing, is solely responsible for making the final selection of the products and systems and assuring that all performance, safety and warning requirements of the application are met.

The products described herein, including without limitation, product features, specifications, designs, availability and pricing, are subject to change by Parker Hannifin Corporation and its subsidiaries at any time without notice.

Offer of Sale

The items described in this document are hereby offered for sale by Parker Hannifin Corporation, its subsidiaries or its authorized distributors. This offer and its acceptance are governed by the provisions stated in the "Offer of Sale".



NFPA D05
 CETOP 5
 NG 10

Code	Description
A	Air Operator

Code	Description
N	Nitrile
V	Fluorocarbon

Code	Description
Omit	Standard
I7*	Monitor Switch

* Available in B, E, H & K styles only.
 Not CE or CSA approved.

Code	Symbol
1	
2	
4	
8*	
9**	
20*	
30**	
81	
82	

* 8 and 20 spools have closed crossover.

** 9 and 30 spools have open crossover

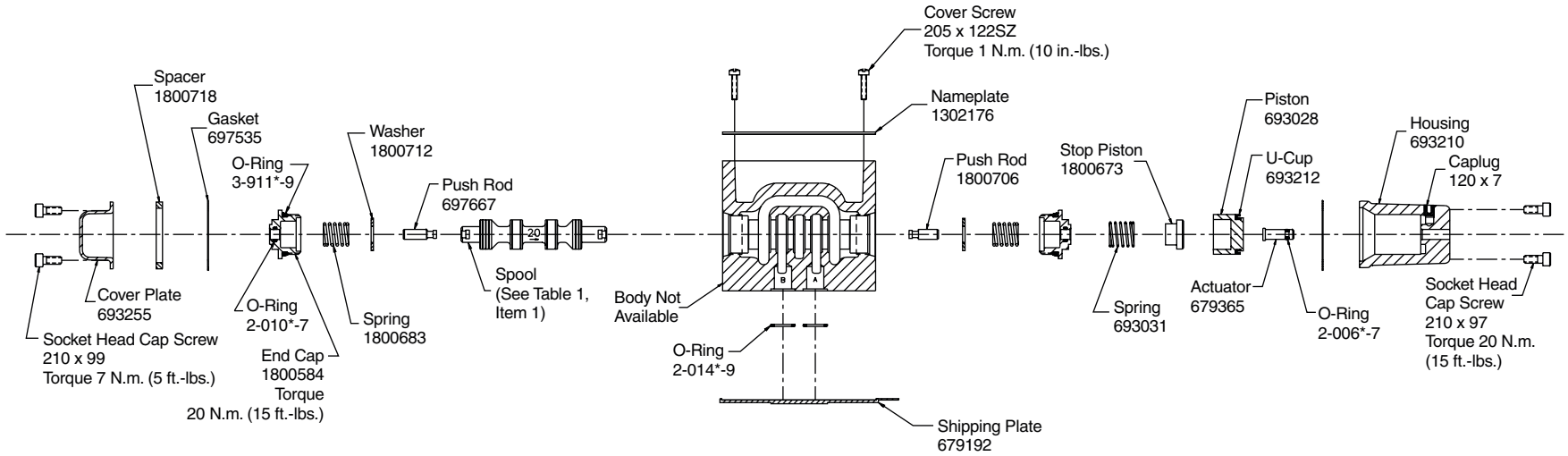
Code	Description
B #	Single operator, two position spring offset. P to A and B to T in offset position.
C	Double operator, three position, spring centered.
D #	Double operator, two position, detent.
E	Two position, spring offset to center. P to B and A to T in offset position.
H #	Single operator, two position, spring offset. P to B and A to T in offset position.
K	Two position, spring offset to center. P to A and B to T in offset position.

B, D & H styles available with 20 and 30 spools only.

Indicates air pilot

This condition varies with spool code

Table 1 (Spools)				
CODE	ITEM	PART NUMBER	QTY	DESCRIPTION
20	1	1800120	1	#20 SPOOL
30	1	1800130	1	#30 SPOOL



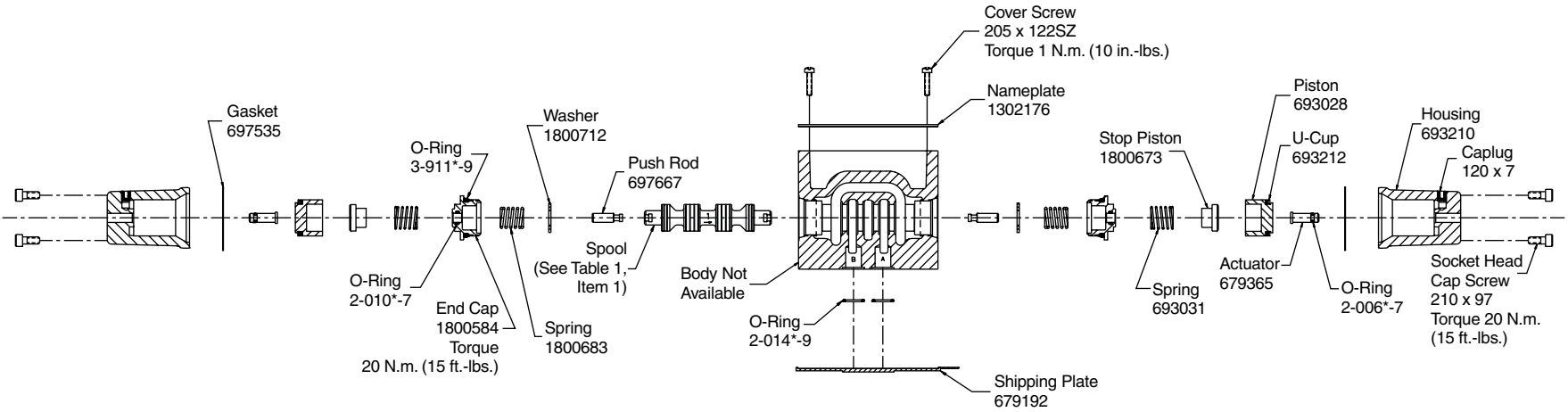
D3A Single Air Actuator Model

NOTES:

1) * Indicates Seal Compound: N-Nitrile, V-Fluorocarbon.

2542-M17.p65, ddi, am

Table 1 (Spools)				
<i>CODE</i>	<i>ITEM</i>	<i>PART NUMBER</i>	<i>QTY</i>	<i>DESCRIPTION</i>
1	1	1800101	1	#1 SPOOL
2	1	1800102	1	#2 SPOOL
4	1	1800104	1	#4 SPOOL
8	1	1800108	1	#8 SPOOL
9	1	1800109	1	#9 SPOOL
81	1	1800181	1	#81 SPOOL
82	1	1800182	1	#82 SPOOL



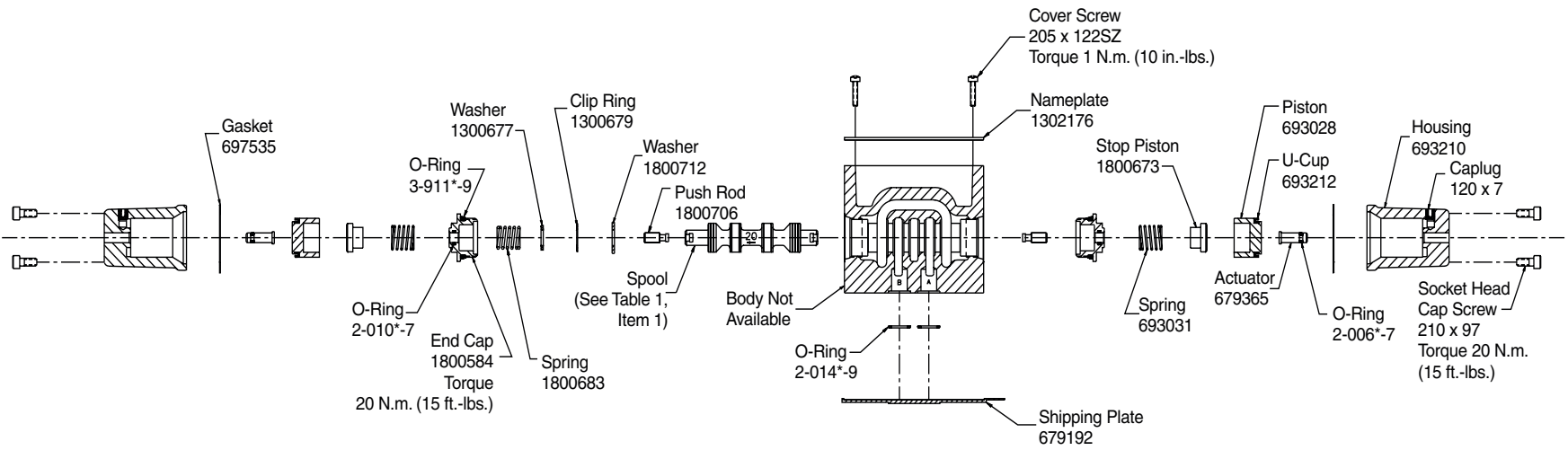
D3A Dual Air Actuator Model

NOTES:

1) * Indicates Seal Compound: N-Nitrile, V-Fluorocarbon.

2542-M17.p65, ddi, am

Table 1 (Spools)				
CODE	ITEM	PART NUMBER	QTY	DESCRIPTION
20	1	1800120	1	#20 SPOOL
30	1	1800130	1	#30 SPOOL



D3A Dual Air Actuator Model

NOTES:

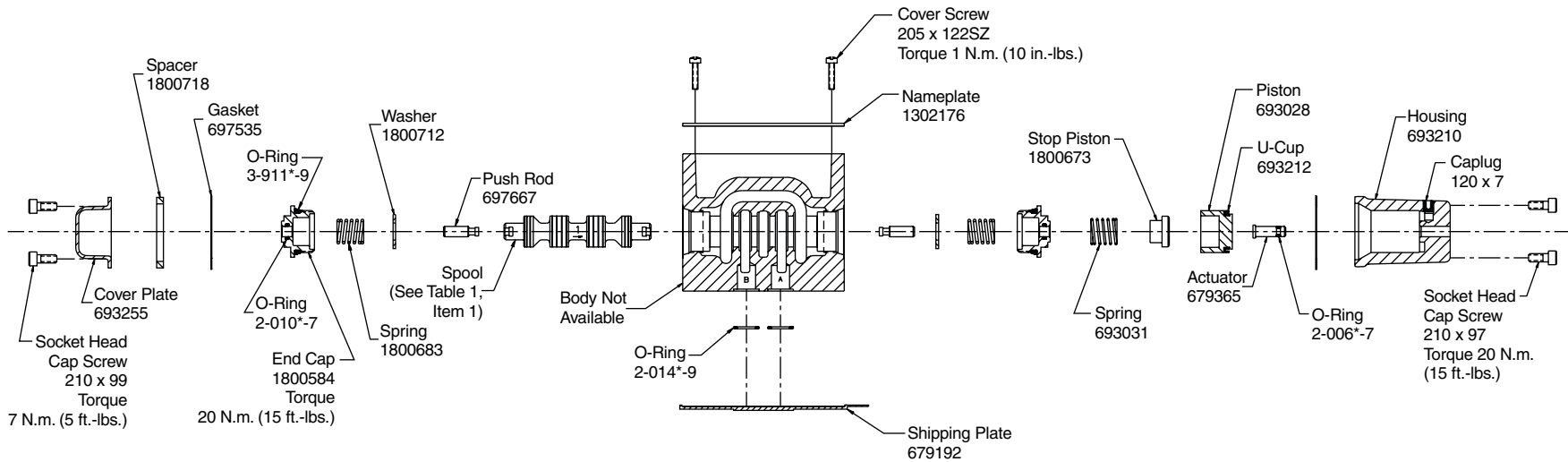
1) * Indicates Seal Compound: N-Nitrile, V-Fluorocarbon.

2542-M17.pds, ddi, am



Hydraulics

Table 1 (Spools)				
CODE	ITEM	PART NUMBER	QTY	DESCRIPTION
1	1	1800101	1	#1 SPOOL
2	1	1800102	1	#2 SPOOL
4	1	1800104	1	#4 SPOOL
8	1	1800108	1	#8 SPOOL
9	1	1800109	1	#9 SPOOL
81	1	1800181	1	#81 SPOOL
82	1	1800182	1	#82 SPOOL

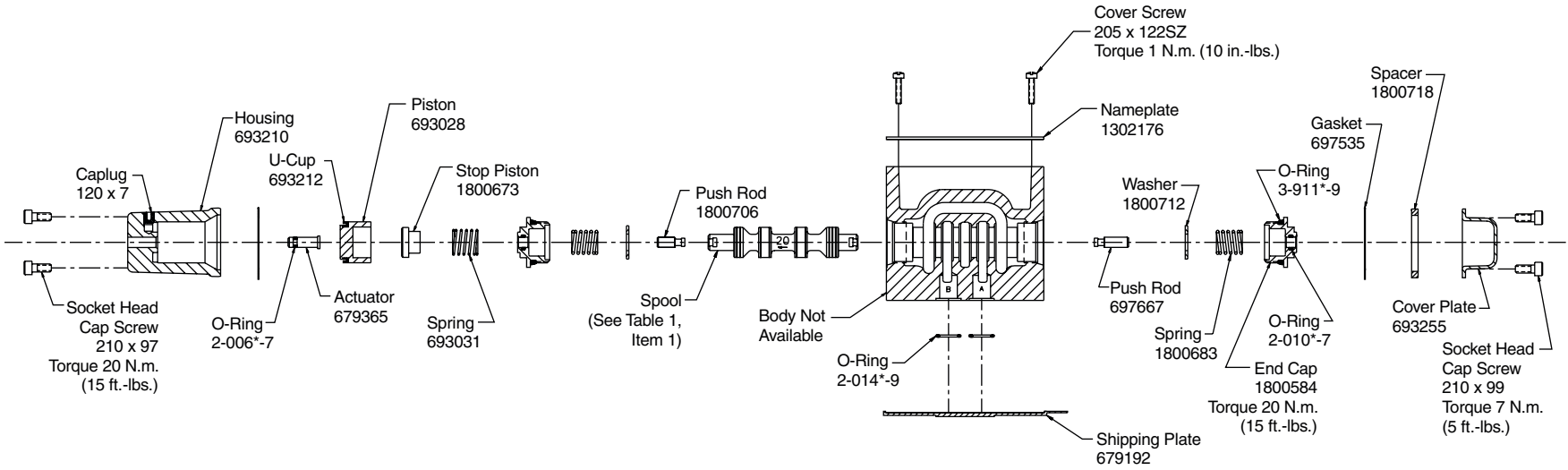


D3A Single Air Actuator Model

NOTES:

1) * Indicates Seal Compound: N-Nitrile, V-Fluorocarbon.

CODE	ITEM	PART NUMBER	QTY	DESCRIPTION
20	1	1800120	1	#20 SPOOL
30	1	1800130	1	#30 SPOOL



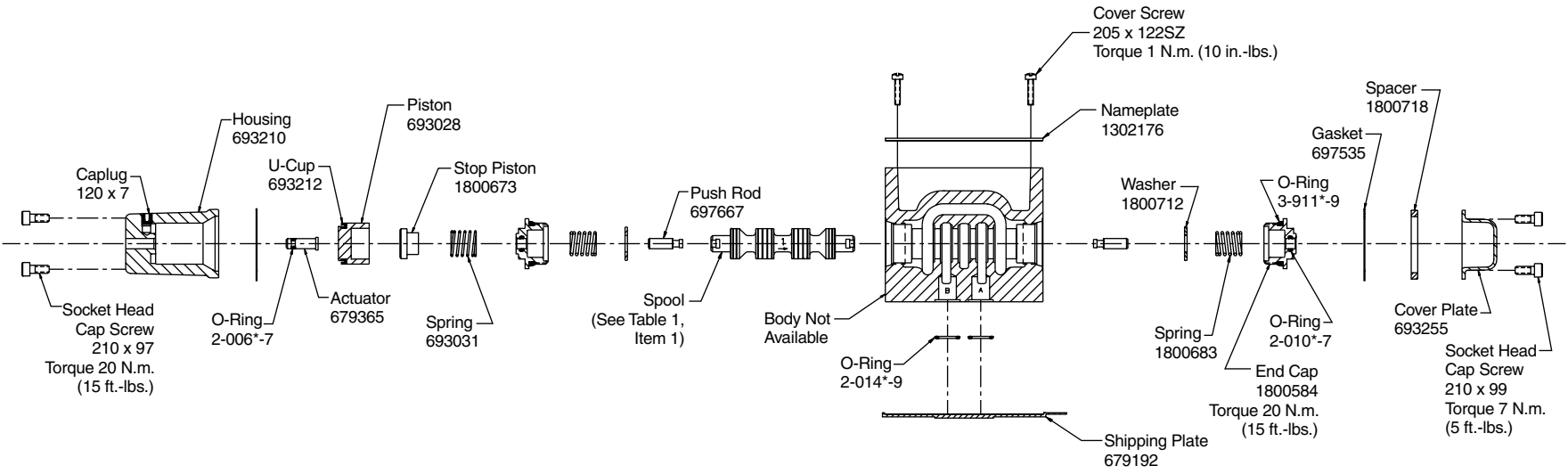
D3A Single Air Actuator Model

NOTES:

1) * Indicates Seal Compound: N-Nitrile, V-Fluorocarbon.

2542-M17.p65, ddi, am


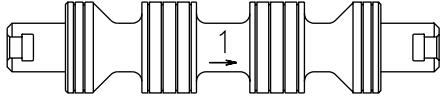

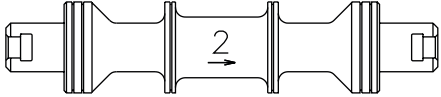

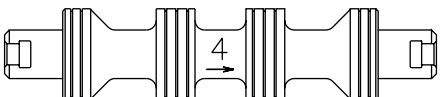

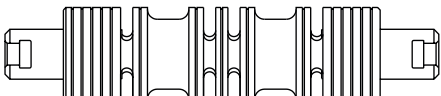

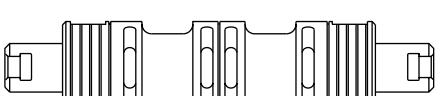

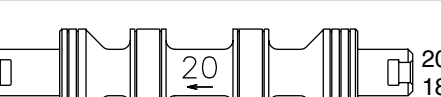

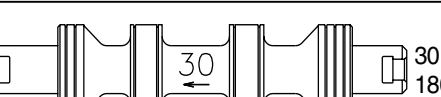

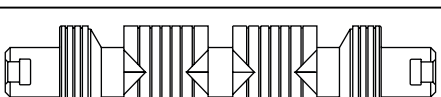

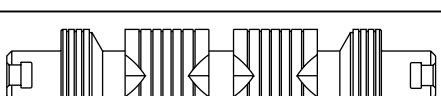
Table 1 (Spools)				
CODE	ITEM	PART NUMBER	QTY	DESCRIPTION
1	1	1800101	1	#1 SPOOL
2	1	1800102	1	#2 SPOOL
4	1	1800104	1	#4 SPOOL
8	1	1800108	1	#8 SPOOL
9	1	1800109	1	#9 SPOOL
81	1	1800181	1	#81 SPOOL
82	1	1800182	1	#82 SPOOL



D3A Single Air Actuator Model

NOTES:

1) * Indicates Seal Compound: N-Nitrile, V-Fluorocarbon.

B-SOLENOID * (A-SOLENOID)	A-SOLENOID * (B-SOLENOID)
	 1 Spool 1800101
	 2 Spool 1800102
	 4 Spool 1800104
	 8 Spool* 1800108
	 9 Spool** 1800109
	 20 Spool* 1800120
	 30 Spool** 1800130
	 81 Spool 1210161
	 82 Spool 1210162

* 8 and 20 spools have closed crossover

** 9 and 30 spools have open crossover

Warning

Before any circuit connection is broken, be sure to turn off all power and relieve system pressure. Lower all vertical loads and cylinders, lock any load which could produce pressure and discharge any accumulators. Plug and cap all lines and openings to prevent contamination from entering the system.

Cleaning and Inspection

1. Proper cleaning is a critical part of preventive maintenance in the use of directional control valves. All parts should be cleaned with a solvent that is compatible with the system fluid. Compressed air may also work well when cleaning orifices and passage ways, but proper filtration must be employed to remove water and contamination.

NOTE: Always make sure all parts have been cleaned before reassembling.

2. Inspection

a. Inspect all passage ways for obstructions.

b. Inspect all washers, push pins, plungers and pole faces for signs of wear and/or mushrooming. Inspect all springs for signs of distortion. Replace parts as necessary.

c. Look for nicks and burrs on the spool and bore lands. Nicks in these areas indicate likely contamination of the system fluid.

3. If there are no signs of nicks or burrs on the spool and bore, check the spool movement as follows:

a. Lubricate the spool and bore with clean system fluid.

b. Insert the spool back into the body and slowly move the spool back and forth. The spool should move freely. If there is any sticking between the spool and the bore, remove the spool and repeat 2a, 2c and 3a.

c. The spool movement can also be checked by placing the valve body on end and inserting the spool. Gravity will pull the spool to the other end if there is no sticking.

d. After several attempts have been made without resolution, replace the valve.

Troubleshooting

Problem: Valve spool fails to move

Cause	Recommendation
Recommended flow exceeded	Check maximum flow rate for appropriate spool by spool function.
Recommended pressure exceeded	Check maximum pressure rating for valve.
Improper installation connections	Check installation drawings.
Contamination in system	Disassemble, inspect, clean and flush.
Improper assembly	Check proper assembly. Refer to drawing for appropriate model.
Valve has silted	Disassemble and clean valve.
Pilot supply off	Turn supply on.
Inadequate pilot pressure	Check pilot pressure specifications for valve model. Check pilot/connections for leak.

Problem: Valve produces undesirable response

Cause	Recommendation
Recommended flow exceeded	Check maximum flow rate for appropriate spool by spool function.
Recommended pressure exceeded	Check maximum pressure rating for valve.
Improper installation connections	Check installation drawings.
Contamination in system	Disassemble, inspect, clean and flush.
Improper assembly	Check proper assembly. Refer to drawing for appropriate model.
Improper fluid	Check fluid recommendations.
Recommended temperature exceeded (indicated by fluid discoloration or spool tarnishing)	Check maximum temperature recommendations.
Inadequate pilot pressure	Check pilot pressure specifications for valve. Check pilot/connections for leak.



Parker Hannifin Corporation
Hydraulic Valve Division
520 Ternes Avenue
Elyria, Ohio 44035 USA
Tel: (440) 366-5200
Fax: (440) 366-5253
Web Site: <http://www.parker.com/hydraulicvalve>

Bulletin 2542-M17/USA,
5M, 1/00, PHD