



Bulletin HY14-1610-M6/US  
Service Bulletin

# Series A4D0131\*\*05 C Design

Effective: July 1, 2007

---

## Directional Control Valves

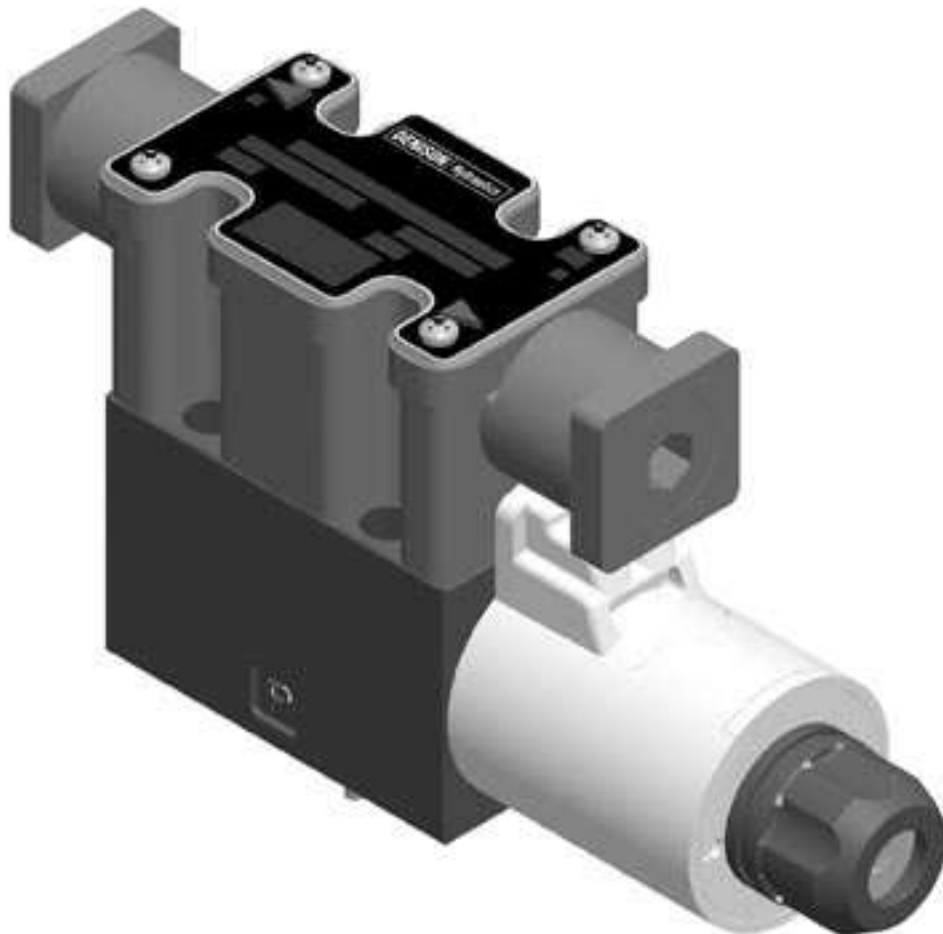

**DENISON** | **Hydraulics**

**WARNING – USER RESPONSIBILITY**

FAILURE OR IMPROPER SELECTION OR IMPROPER USE OF THE PRODUCTS DESCRIBED HEREIN OR RELATED ITEMS CAN CAUSE DEATH, PERSONAL INJURY AND PROPERTY DAMAGE.

- This document and other information from Parker-Hannifin Corporation, its subsidiaries and authorized distributors provide product or system options for further investigation by users having technical expertise.
- The user, through its own analysis and testing, is solely responsible for making the final selection of the system and components and assuring that all performance, endurance, maintenance, safety and warning requirements of the application are met. The user must analyze all aspects of the application, follow applicable industry standards, and follow the information concerning the product in the current product catalog and in any other materials provided from Parker or its subsidiaries or authorized distributors.
- To the extent that Parker or its subsidiaries or authorized distributors provide component or system options based upon data or specifications provided by the user, the user is responsible for determining that such data and specifications are suitable and sufficient for all applications and reasonably foreseeable uses of the components or systems.

**OFFER OF SALE**

The items described in this document are hereby offered for sale by Parker-Hannifin Corporation, its subsidiaries or its authorized distributors. This offer and its acceptance are governed by the provisions stated in the detailed "Offer of Sale" elsewhere in this document or available at [www.parker.com/hydraulicvalve](http://www.parker.com/hydraulicvalve).

**SAFETY GUIDE**

For safety information, see Safety Guide SG HY14-1000 at [www.parker.com/safety](http://www.parker.com/safety) or call 1-800-CParker.

© Copyright 2007, Parker Hannifin Corporation, All Rights Reserved

Bul HY14-1610-M6.indd, dd

**Contents**

**Model Code**

Standard Valves..... 1

**Parts Data**

A4D0131\*\*0501\*\*\*\*61 (Conduit Box, Plug-In)..... 2

A4D0131\*\*0501\*\*\*\*28 (Conduit Box, Leadwire)..... 3

A4D0131\*\*0501 (DIN without Plug) ..... 4

A4D0131\*\*0501\*\*\*\*61G3 (Conduit Box, Soft Shift, Plug-In) ..... 5

A4D0131\*\*0501\*\*\*\*G3 (DIN Soft Shift, without Plug, DC Only) ..... 6

A4D0131\*\*0501\*\*\*\*D2 (UL/CSA), A4D0131\*\*0501\*\*\*\*AM (ATEX EEXME) ..... 7

**Ordering Information** ..... 8

**Spool Chart** ..... 9

**Wiring Instructions** ..... 10

**Coil Data** ..... 11

**Troubleshooting Guide** ..... 12-13

**Terms of Sale with Warranty Limitations**..... 14

**Model Code**

**Directional Control Valves**

**Series A4D0131\*\*05**

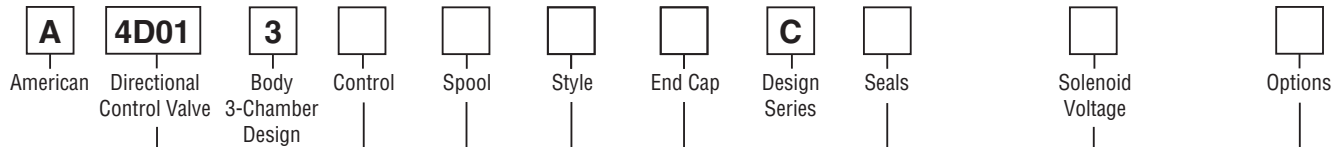

NFPA D03  
CETOP 3  
DIN NG6

Code	Description
1	1 Solenoid
2	2 Solenoids
7*	2 Solenoids and 2 Position Detents

\* Spools 11 and 51 only

Code	Description
01	For Control 1
02	For Control 2 and 7

Code	Description
G0Q	24 VDC
G0R	12 VDC
GAN	98 VDC
W30	120/60 – 110/50 VAC
W31	240/60 – 220/50 VAC

Code	Description
1	NBR
4	EPR
5	FPM

Code	Description
Omit	Standard Valve
28	Wiring Box w/o Terminal Strip
32†	Solenoid Tube w/o Manual Override
52	Extended Solenoid Tube w/Rubber Boot
61*	Wiring Box w/Lights
62**	Wiring Box w/Lights, Brad Harrison Connector
D2	CSA/UL Explosion Proof
G3†	Soft Shift w/0.030" Orifice

\* Replaces 81 Option.  
\*\* Replaces 49 Option.  
† DC only.

Code	Symbol	Code	Symbol
01		11*	
02		12**	
03		46	
07*		51**	
08		64	
09		65	
10			

\* 07 and 11 spools have open crossover.  
\*\* 12 and 51 spools have closed crossover

All valves are CSA certified.

**Valve Weight:**

Single Solenoid 1.36 kg (3.0 lbs.)  
Double Solenoid 1.6 kg (3.5 lbs.)

**Standard Bolt Kit:**

BK209

**Metric Bolt Kit:**

BKM209

Code	Description	Symbol
01*	Single solenoid, 2 position, spring offset. P to A and B to T in offset position.	
02*	Single solenoid, 2 position, spring offset. P to B and A to T in offset position.	
03	Double solenoid, 3 position, spring centered.	
05	Single solenoid, 2 position, spring centered. P to A and B to T when energized.	
06	Single solenoid, 2 position, spring centered. P to B and A to T when energized.	
09	Double solenoid, 2 position, detent.	

\* Spools 11, 12 and 51 only

**A4D0131\*\*0501\*\*\*61 Conduit Box, Plug-in**

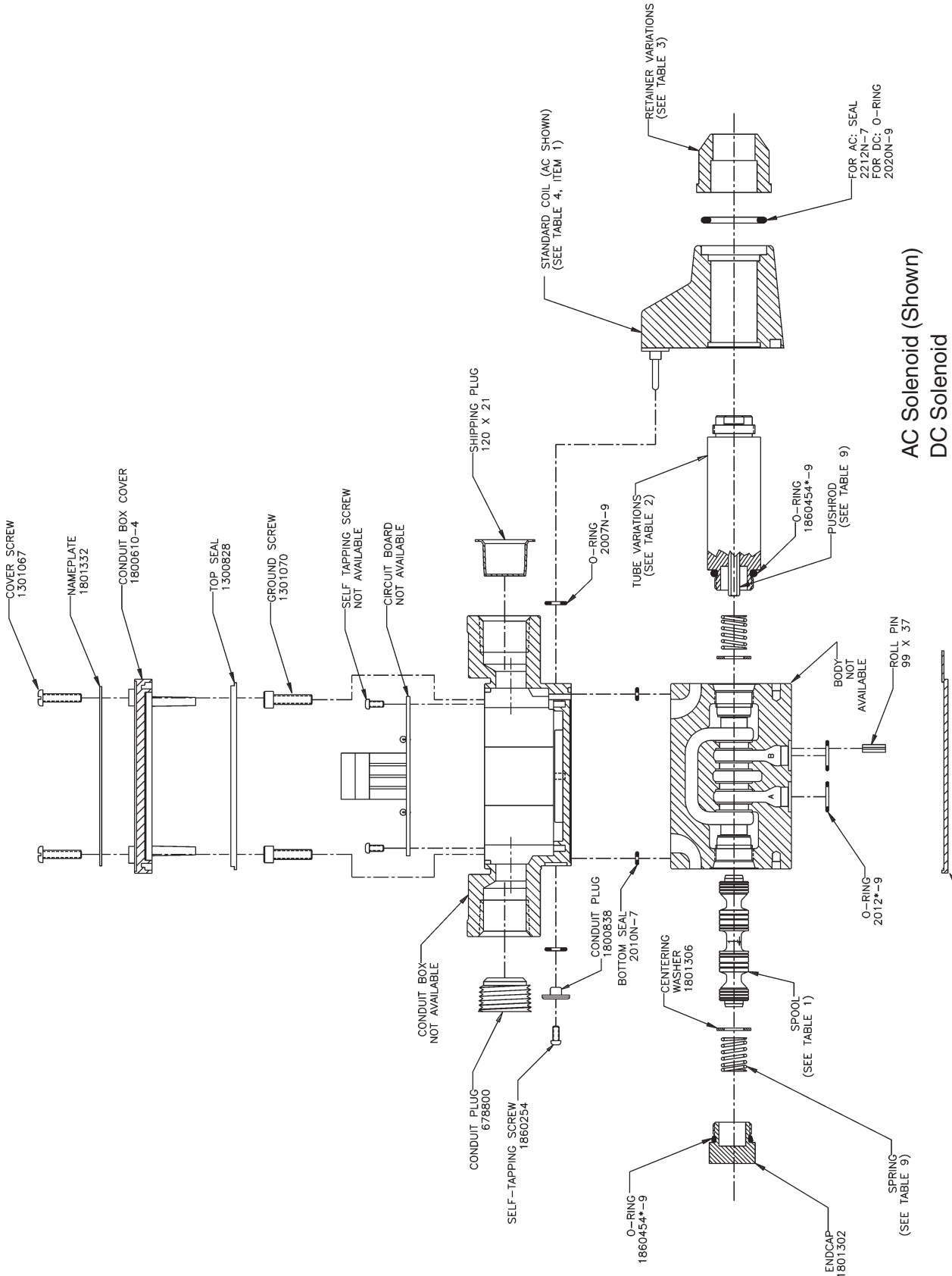

AC Solenoid (Shown)  
 DC Solenoid

A4D01 Single A.C. Solenoid Model  
 A4D01 Single D.C. Solenoid Model

Notes:  
 1) \* Indicates Seal Compound:  
 N = Nitrile, V = Fluorocarbon, E = EPR

**A4D0131\*\*0501\*\*\*\*28 Conduit Box, Leadwire**

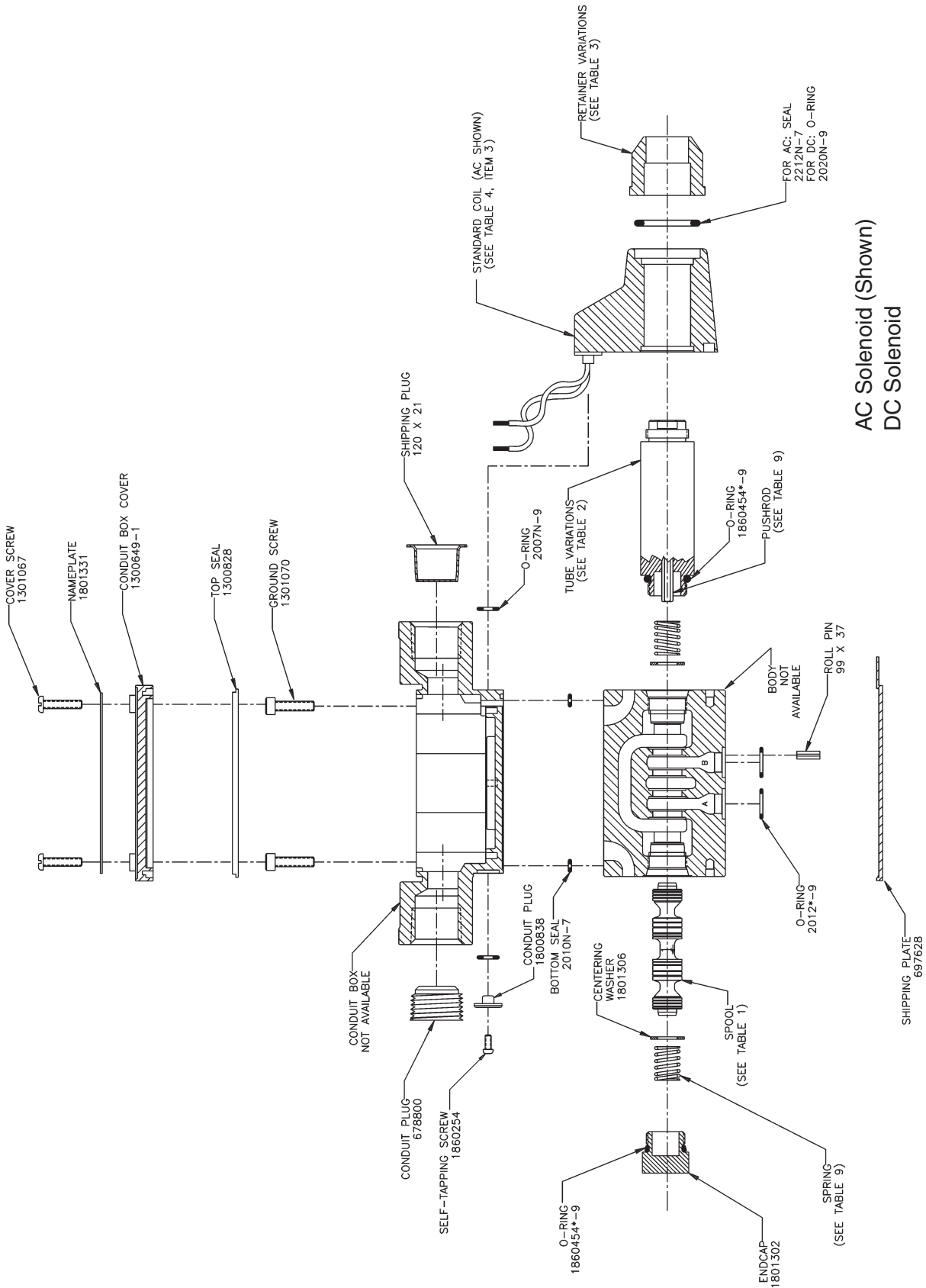

AC Solenoid (Shown)  
 DC Solenoid

A4D01 Single A.C. Solenoid Model  
 A4D01 Single D.C. Solenoid Model

Notes:  
 1) \* Indicates Seal Compound:  
 N = Nitrile, V = Fluorocarbon, E = EPR

**A4D0131\*\*0501**

**DIN without Plug**

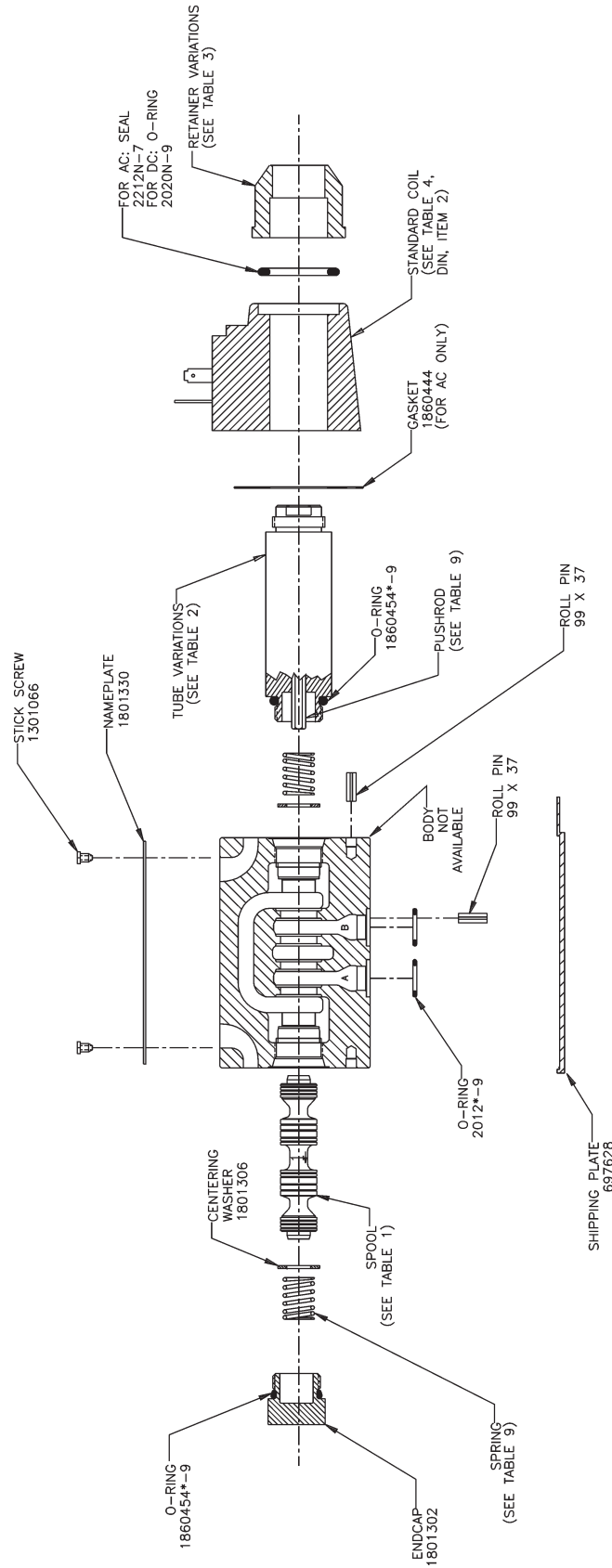

AC Solenoid (Shown)  
 DC Solenoid

A4D01 Single A.C. Solenoid Model  
 A4D01 Single D.C. Solenoid Model

Note:  
 1) \* Indicates Seal Compound:  
 N = Nitrile, V = Fluorocarbon, E = EPR





**A4D0131\*\*0501\*\*\*G3 DIN Soft Shift without Plug (DC Only)**

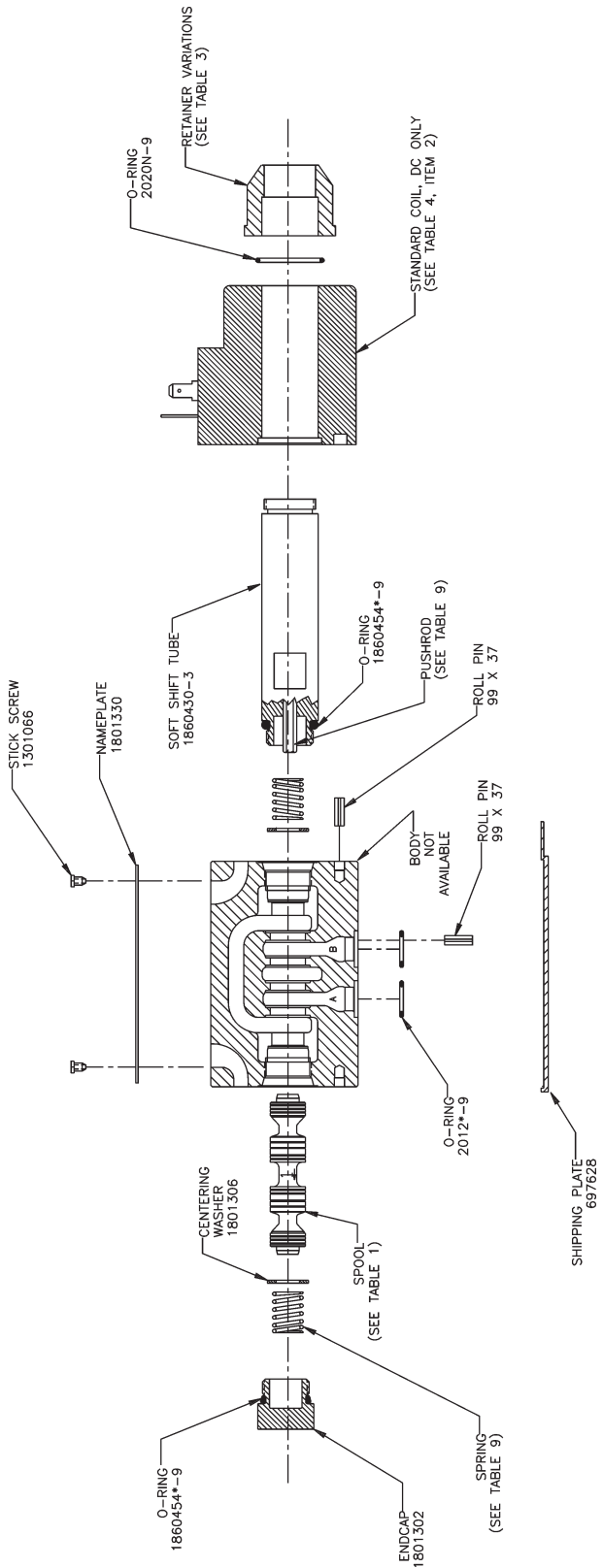

DC Solenoid

A4D01 Single D.C. Solenoid Model

Note:  
 1) \* indicates Seal Compound:  
 N = Nitrile, V = Fluorocarbon, E = EPR

**A4D0131\*\*0501\*\*\*\*D2**  
**A4D0131\*\*0501\*\*\*\*AM**

**UL / CSA**  
**ATEX EEXME**

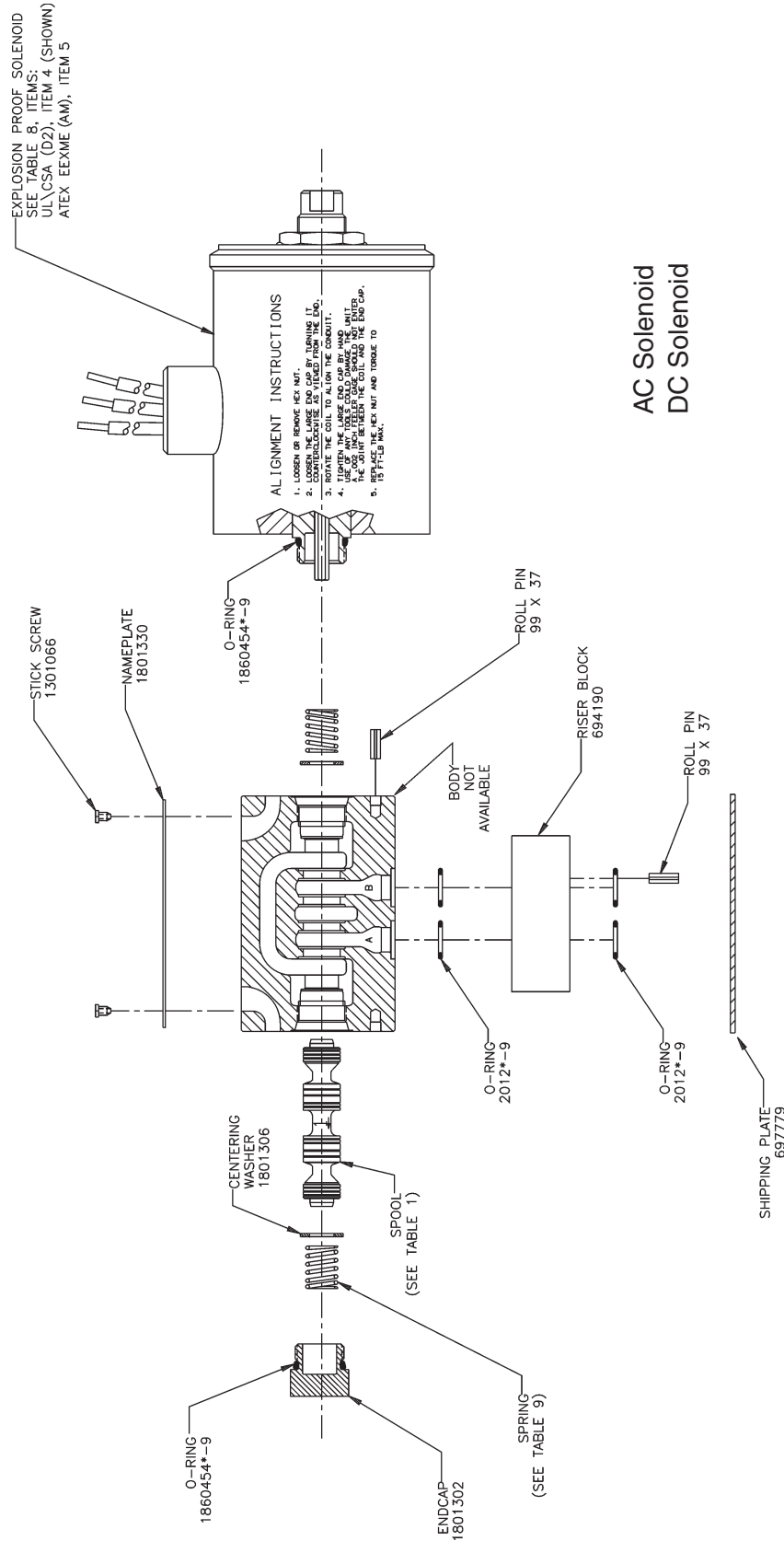

**AC Solenoid**  
**DC Solenoid**

**A4D01 Single A.C. Solenoid Explosion Proof Model**  
**A4D01 Single D.C. Solenoid Explosion Proof Model**

Note:  
 1) \* Indicates Seal Compound:  
 N = Nitrile, V = Fluorocarbon, E = EPR

Code	Part Number	Qty	Description
01	697602	1	#01 Spool
02	697611	1	#02 Spool
03	697601	1	#03 Spool
07	1302128	1	#07 Spool
08	697604	1	#08 Spool
09	697603	1	#10 Spool Reversed
10	697603	1	#10 Spool
46	697606	1	#46 Spool
55	697621	1	#55 Spool
56	697621	1	#55 Spool Reversed
64	697607	1	#65 Spool Reversed
65	697607	1	#65 Spool

△1

△2

- △1 Arrow points toward “A” port for all spools except: 09, 56 & 64.
- △2 With 07 spools, solenoid is on opposite end of that shown in illustration.











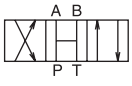
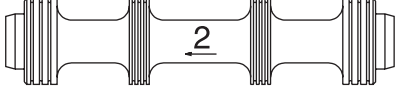

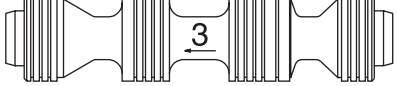
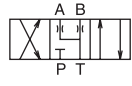
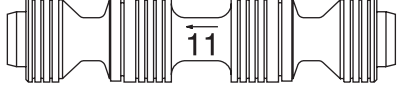
Code	Part Number	Qty	Description
Omit	1860432	1	A.C. Tube 1500 PSI
Omit	1860428	1	D.C. Tube 3000 PSI
52	1860434	1	Extended A.C. Tube 1500 PSI
52	1860429	1	Extended D.C. Tube 3000 PSI

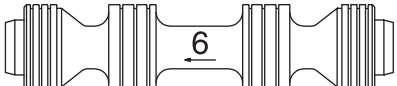
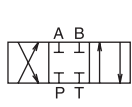
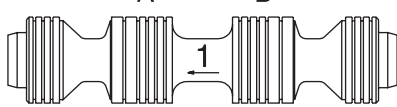
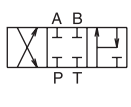
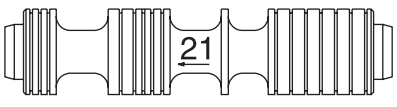
Code	Part Number	Qty	Description
All Except 32 and 52	1860456	1	AC Standard Retainer
	1860437		DC Standard Retainer
32	1860438	1	DC Tamper Proof Retainer
52	1860463	1	AC Extended Override Retainer
	1860452		AC Extended Override Boot
52	1860437	1	DC Extended Override Retainer
	1860452		DC Extended Override Boot

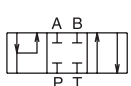
Solenoid Connection			61 (Conduit Box) (Plug-In)	Omit (DIN)	28 (Conduit Box) (Leadwire)
Item			1	2	3
Code	Description	Qty	Part Number	Part Number	Part Number
G0Q	24 VDC	1	1860410-30-24	1860414-30-24	1860435-30-24
G0R	12 VDC	1	1860410-30-12	1860414-30-12	1860435-30-12
GAN	98 VDC	1	N/A	1860414-30-98	N/A
W30	120/60–110/50 VAC 21 Watt	1	1860422-21-Y	1860423-21-Y	1860436-21-Y
W31	240/60–220/50 VAC 21 Watt	1	1860422-21-T	1860423-21-T	1860436-21-T

Solenoid Connection			D2 (UL/CSA)	AM (EEXME)
Item			4	5
Code	Description	Qty	Part Number	Part Number
G0Q	24 VDC	1	1860421-33-24	1860419-30-24
G0R	12 VDC	1	1860421-33-12	1860419-30-12
W30	120/60 VAC	1	1860427-27-Y	1860425-30-Y
W31	240/60 VAC	1	1860427-27-T	1860425-30-T

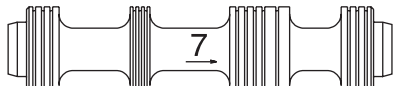
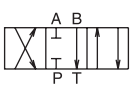
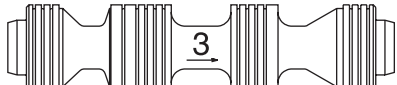
Valve	Spool	Description	Style	Spring			Pushrod				
				1860447	1860446	1860445	1860400	1860401	1860402	1860403	1860404
Standard (Non-Soft Shift) Valve	02, 03, 08, 55, 56	DC-30W	All								
		AC-21W	All								
	01, 07, 09, 10, 11, 12, 46, 51, 64, 65	DC-30W	All								
		AC-21W	All								
	11, 51	DC-30W	09								
		AC-21W	09								
Soft Shift Valve	02, 03, 08, 55, 56	DC-30W	All								
	01, 07, 09, 10, 11, 12, 46, 51, 64, 65	DC-30W	All								
	11, 51	DC-30W	09								

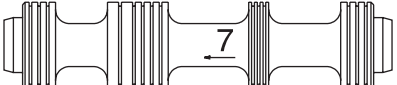
B-SOLENOID	A-SOLENOID	B-SOLENOID	A-SOLENOID
* (A-SOLENOID)	* (B-SOLENOID)	* (A-SOLENOID)	* (B-SOLENOID)
	 <p>01 Spool 697602</p>		 <p>10 Spool 697603</p>
	 <p>02 Spool 697611</p>		 <p>46 Spool 697606</p>
	 <p>03 Spool 697601</p>		 <p>55 Spool 697621</p>
	 <p>07 Spool 1302128</p> <p>*Note Reverse Operator Location</p>		 <p>56 Spool 697621</p>
	 <p>08 Spool 697604</p>		 <p>64 Spool 697607</p>
	 <p>09 Spool 697603</p>		 <p>65 Spool 697607</p>

**Option 62 – Single Solenoid Plug-in Models  
with Lights and 3-Pin Manaplug (Brad Harrison)**

Valve	Spool	Nameplate Marking	Wiring Diagram	Sol. Code	Item	Part Number	Qty	Description
A4D01	All Spools Except 07			A L L	1	1302151	1	Manaplug, 3-Pin
A4D01	Spool 07 Only				2	1800707	1	Warning Label
A4D01	All Spools Except 07				4	1800610-4	1	Conduit Box Cover
A4D01	Spool 07 Only				5	1801332	1	Nameplate

● Wiring diagrams show the backside of plug.

**Plug-in Conduit Box (Option 62)**

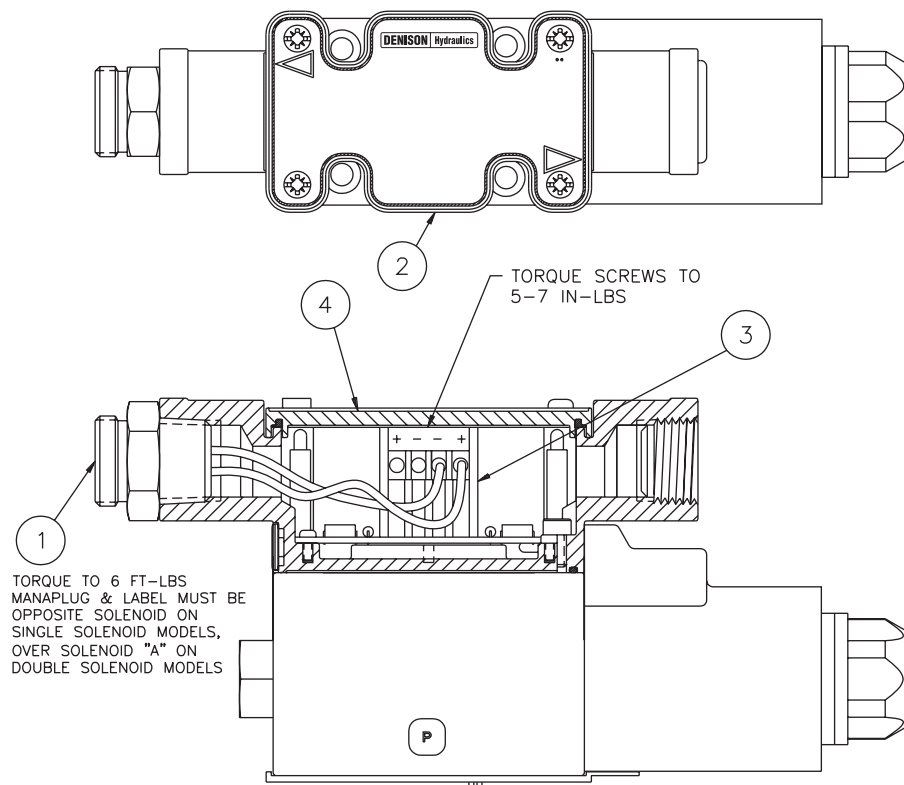

Note: 02 and 05 spool positions shown

**Wiring Instructions**

*(Dashed lines indicate wiring thru terminal strip – no assembly required here)*

1. Install manaplug (Item 1) over solenoid "A" on double solenoid models (opposite solenoid on single solenoid models).
2. Slip ground screw (1301070) through ring terminal on green ground wire (from manaplug) and secure to valve body.
3. Insert manaplug wires into terminal strip (Item 3) in box as shown in wiring diagram. Ensure all wire strands are contained by the connector and tighten clamping screws to 0.5 Nm (5 in. lbs.).
4. Install cover (Item 4) on the conduit box.
5. Place warning label (Item 2) on conduit box side, as shown.

## Solenoid Ratings

<b>Insulation</b>	Class H
<b>Allowable Deviation from rated voltage</b>	-15% to +10% for DC coils -5% to +5% for AC coils
<b>Armature</b>	Wet pin type
<b>CSA File Number</b>	LR60407
<b>Environmental Capability</b>	DC Solenoids meet NEMA 4 and IP67 when properly wired and installed. Contact HVD for AC coil applications.

## Explosion Proof Solenoid Ratings\*

<b>UL &amp; CSA (D2)</b>	Class I, Div 1 & 2, Groups C & D Class II, Div 1 & 2, Groups E, F & G As defined by the NEC
--------------------------	---

\* Allowable Voltage Deviation  $\pm 10\%$ .

Note that Explosion Proof AC coils are single frequency only.

Voltage Code	Voltage	In Rush Amps Amperage @ 3mm	In Rush VA A4D01 VA @ 3mm	Holding Amps A4D01	Watts A4D01	Resistance A4D01
G0Q	24 VDC	N/A	N/A	1.32 Amps	30 W	17.27 ohms
G0R	12 VDC	N/A	N/A	2.64 Amps	30 W	4.32 ohms
GAN	98 VDC	N/A	N/A	2.88 Amps	30 W	352.00 ohms
W30	120/60 VAC	1.40 Amps	168 VA	0.42 Amps	21 W	36.50 ohms
W30	110/50 VAC	1.50 Amps	165 VA	0.50 Amps	23 W	36.50 ohms
W31	240/60 VAC	0.70 Amps	168 VA	0.22 Amps	21 W	145.00 ohms
W31	220/50 VAC	0.75 Amps	165 VA	0.26 Amps	23 W	145.00 ohms
<b>Explosion Proof Solenoids</b>						
G0Q	24 VDC	N/A	N/A	1.38 Amps	33 W	17.33 ohms
G0R	12 VDC	N/A	N/A	2.75 Amps	33 W	4.36 ohms
W30	120/60 VAC	1.60 Amps	192 VA	0.58 Amps	27 W	33.50 ohms
W31	240/60 VAC	0.76 Amps	183 VA	0.29 Amps	27 W	1.34 ohms

## Warning

Before any circuit connection is broken, be sure to turn off all power and relieve system pressure. Lower all vertical loads and cylinders, lock any load which could produce pressure and discharge any accumulators. Plug and cap all lines and openings to prevent contamination from entering the system.

## Cleaning and Inspection

1. Proper cleaning is a critical part of preventive maintenance in the use of directional control valves. All parts should be cleaned with a solvent that is compatible with the system fluid. Compressed air may also work well when cleaning orifices and passage ways, but proper filtration must be employed to remove water and contamination.

**NOTE:** Always make sure all parts have been cleaned before reassembling.

### 2. Inspection

- a. Inspect all passage ways for obstructions.
- b. Inspect all washers, push pins, plungers and pole faces for signs of wear and/or mushrooming. Inspect all springs for signs of distortion. Replace parts as necessary.
- c. Look for nicks and burrs on the spool and bore lands. Nicks in these areas indicate likely contamination of the system fluid.

3. If there are no signs of nicks or burrs on the spool and bore, check the spool clearance as follows:

- a. Lubricate the spool and bore with clean system fluid.
- b. Insert the spool back into the body and slowly move the spool back and forth. The spool should move freely. If there is any sticking between the spool and the bore, remove the spool and repeat 2b.
- c. The spool clearance can also be checked by placing the valve body on end and inserting the spool. Gravity will pull the spool to the other end if there is no sticking.
- d. After several attempts have been made without resolution, replace the valve.

## Troubleshooting

### Problem: Valve spool fails to move

	Cause	Recommendation
<b>Mechanical</b>	Recommended flow exceeded	Check maximum flow rate for appropriate spool by spool function.
	Recommended pressure exceeded	Check maximum pressure rating for valve.
	Improper installation connections	Check installation drawings.
	Contamination in system	Disassemble, inspect, clean and flush.
	Improper assembly	Check proper assembly. Refer to drawing for appropriate model.
	Valve has silted	Disassemble and clean valve.
<b>Electrical</b>	Power off	Turn power on.
	Improper voltage	Check voltage requirements for valve model.
	Faulty connection	Check connections.
	Faulty coil	Check coil resistance.

**Problem: Valve produces undesirable response**

	<b>Cause</b>	<b>Recommendation</b>
<b>Mechanical</b>	Recommended flow exceeded	Check maximum flow rate for appropriate spool by spool function.
	Recommended pressure exceeded	Check maximum pressure rating for valve.
	Improper installation connections	Check installation drawings.
	Contamination in system	Disassemble, inspect, clean and flush.
	Improper assembly	Check proper assembly. Refer to drawing for appropriate model.
	Improper fluid	Check fluid recommendations.
	Recommended temperature exceeded (indicated by fluid discoloration or spool tarnishing)	Check maximum temperature recommendations.
<b>Electrical</b>	Improper voltage	Check voltage requirements for valve model.
	Faulty connection	Check connections.
	Faulty coil	Check coil resistance.



## Terms of Sale with Warranty Limitations

### Offer of Sale

The items described in this document and other documents or descriptions provided by Parker Hannifin Corporation, its subsidiaries and its authorized distributors are hereby offered for sale at prices to be established by Parker Hannifin Corporation, its subsidiaries and its authorized distributors. This offer and its acceptance by any customer ("Buyer") shall be governed by all of the following Terms and Conditions. Buyer's order for any such items, when communicated to Parker Hannifin Corporation, its subsidiary or an authorized distributor ("Seller") verbally or in writing, shall constitute acceptance of this offer.

**1. Terms and Conditions of Sale:** All descriptions, quotations, proposals, offers, acknowledgments, acceptances and sales of Seller's products are subject to and shall be governed exclusively by the terms and conditions stated herein. Buyer's acceptance of any offer to sell is limited to these terms and conditions. Any terms or conditions in addition to, or inconsistent with those stated herein, proposed by Buyer in any acceptance of an offer by Seller, are hereby objected to. No such additional, different or inconsistent terms and conditions shall become part of the contract between Buyer and Seller unless expressly accepted in writing by Seller. Seller's acceptance of any offer to purchase by Buyer is expressly conditional upon Buyer's assent to all the terms and conditions stated herein, including any terms in addition to, or inconsistent with those contained in Buyer's offer. Acceptance of Seller's products shall in all events constitute such assent.

**2. Payment:** Payment shall be made by Buyer net 30 days from the date of delivery of the items purchased hereunder. Amounts not timely paid shall bear interest at the maximum rate permitted by law for each month or portion thereof that the Buyer is late in making payment. Any claims by Buyer for omissions or shortages in a shipment shall be waived unless Seller receives notice thereof within 30 days after Buyer's receipt of the shipment.

**3. Delivery:** Unless otherwise provided on the face hereof, delivery shall be made F.O.B. Seller's plant. Regardless of the method of delivery, however, risk of loss shall pass to Buyer upon Seller's delivery to a carrier. Any delivery dates shown are approximate only and Seller shall have no liability for any delays in delivery.

**4. Warranty:** Seller warrants that the items sold hereunder shall be free from defects in material or workmanship for a period of 18 months from date of shipment from Parker Hannifin Corporation. **THIS WARRANTY COMPRISES THE SOLE AND ENTIRE WARRANTY PERTAINING TO ITEMS PROVIDED HEREUNDER. SELLER MAKES NO OTHER WARRANTY, GUARANTEE, OR REPRESENTATION OF ANY KIND WHATSOEVER. ALL OTHER WARRANTIES, INCLUDING BUT NOT LIMITED TO, MERCHANTABILITY AND FITNESS FOR PURPOSE, WHETHER EXPRESS, IMPLIED, OR ARISING BY OPERATION OF LAW, TRADE USAGE, OR COURSE OF DEALING ARE HEREBY DISCLAIMED. NOTWITHSTANDING THE FOREGOING, THERE ARE NO WARRANTIES WHATSOEVER ON ITEMS BUILT OR ACQUIRED WHOLLY OR PARTIALLY, TO BUYER'S DESIGNS OR SPECIFICATIONS.**

**5. Limitation Of Remedy: SELLER'S LIABILITY ARISING FROM OR IN ANY WAY CONNECTED WITH THE ITEMS SOLD OR THIS CONTRACT SHALL BE LIMITED EXCLUSIVELY TO REPAIR OR REPLACEMENT OF THE ITEMS SOLD OR REFUND OF THE PURCHASE PRICE PAID BY BUYER, AT SELLER'S SOLE OPTION. IN NO EVENT SHALL SELLER BE LIABLE FOR ANY INCIDENTAL, CONSEQUENTIAL OR SPECIAL DAMAGES OF ANY KIND OR NATURE WHATSOEVER, INCLUDING BUT NOT LIMITED TO LOST PROFITS ARISING FROM OR IN ANY WAY CONNECTED WITH THIS AGREEMENT OR ITEMS SOLD HEREUNDER, WHETHER ALLEGED TO ARISE FROM BREACH OF CONTRACT, EXPRESS OR IMPLIED WARRANTY, OR IN TORT, INCLUDING WITHOUT LIMITATION, NEGLIGENCE, FAILURE TO WARN OR STRICT LIABILITY.**

**6. Changes, Reschedules and Cancellations:** Buyer may request to modify the designs or specifications for the items sold hereunder as well as the quantities and delivery dates thereof, or may request to cancel all or part of this order, however, no such requested modification or cancellation shall become part of the contract between Buyer and Seller unless accepted by Seller in a written amendment to this Agreement. Acceptance of any such requested modification or cancellation shall be at Seller's discretion, and shall be upon such terms and conditions as Seller may require.

**7. Special Tooling:** A tooling charge may be imposed for any special tooling, including without limitation, dies, fixtures, molds and patterns, acquired to manufacture items sold pursuant to this contract. Such special tooling shall be and remain Seller's property notwithstanding payment of any charges by Buyer. In no event will Buyer acquire any interest in apparatus belonging to Seller which is utilized in the manufacture of the items sold hereunder, even if such apparatus has been specially converted or adapted for such manufacture and notwithstanding any charges paid

by Buyer. Unless otherwise agreed, Seller shall have the right to alter, discard or otherwise dispose of any special tooling or other property in its sole discretion at any time.

**8. Buyer's Property:** Any designs, tools, patterns, materials, drawings, confidential information or equipment furnished by Buyer or any other items which become Buyer's property, may be considered obsolete and may be destroyed by Seller after two (2) consecutive years have elapsed without Buyer placing an order for the items which are manufactured using such property, Seller shall not be responsible for any loss or damage to such property while it is in Seller's possession or control.

**9. Taxes:** Unless otherwise indicated on the face hereof, all prices and charges are exclusive of excise, sales, use, property, occupational or like taxes which may be imposed by any taxing authority upon the manufacture, sale or delivery of the items sold hereunder. If any such taxes must be paid by Seller or if Seller is liable for the collection of such tax, the amount thereof shall be in addition to the amounts for the items sold. Buyer agrees to pay all such taxes or to reimburse Seller therefore upon receipt of its invoice. If Buyer claims exemption from any sales, use or other tax imposed by any taxing authority, Buyer shall save Seller harmless from and against any such tax, together with any interest or penalties thereon which may be assessed if the items are held to be taxable.

**10. Indemnity For Infringement of Intellectual Property Rights:** Seller shall have no liability for infringement of any patents, trademarks, copyrights, trade dress, trade secrets or similar rights except as provided in this Part 10. Seller will defend and indemnify Buyer against allegations of infringement of U.S. Patents, U.S. Trademarks, copyrights, trade dress and trade secrets (hereinafter 'Intellectual Property Rights'). Seller will defend at its expense and will pay the cost of any settlement or damages awarded in an action brought against Buyer based on an allegation that an item sold pursuant to this contract infringes the Intellectual Property Rights of a third party. Seller's obligation to defend and indemnify Buyer is contingent on Buyer notifying Seller within ten (10) days after Buyer becomes aware of such allegations of infringement, and Seller having sole control over the defense of any allegations or actions including all negotiations for settlement or compromise. If an item sold hereunder is subject to a claim that it infringes the Intellectual Property Rights of a third party, Seller may, at its sole expense and option, procure for Buyer the right to continue using said item, replace or modify said item so as to make it noninfringing, or offer to accept return of said item and return the purchase price less a reasonable allowance for depreciation. Notwithstanding the foregoing, Seller shall have no liability for claims of infringement based on information provided by Buyer, or directed to items delivered hereunder for which the designs are specified in whole or part by Buyer, or infringements resulting from the modification, combination or use in a system of any item sold hereunder. The foregoing provisions of this Part 10 shall constitute Seller's sole and exclusive liability and Buyer's sole and exclusive remedy for infringement of Intellectual Property Rights.

If a claim is based on information provided by Buyer or if the design for an item delivered hereunder is specified in whole or in part by Buyer, Buyer shall defend and indemnify Seller for all costs, expenses or judgments resulting from any claim that such item infringes any patent, trademark, copyright, trade dress, trade secret or any similar right.

**11. Force Majeure:** Seller does not assume the risk of and shall not be liable for delay or failure to perform any of Seller's obligations by reason of circumstances beyond the reasonable control of Seller (hereinafter 'Events of Force Majeure'). Events of Force Majeure shall include without limitation, accidents, acts of God, strikes or labor disputes, acts, laws, rules or regulations of any government or government agency, fires, floods, delays or failures in delivery of carriers or suppliers, shortages of materials and any other cause beyond Seller's control.

**12. Entire Agreement/Governing Law:** The terms and conditions set forth herein, together with any amendments, modifications and any different terms or conditions expressly accepted by Seller in writing, shall constitute the entire Agreement concerning the items sold, and there are no oral or other representations or agreements which pertain thereto. This Agreement shall be governed in all respects by the law of the State of Ohio. No actions arising out of the sale of the items sold hereunder or this Agreement may be brought by either party more than two (2) years after the cause of action accrues.







**Parker Hannifin Corporation**  
Hydraulic Valve Division  
520 Ternes Avenue  
Elyria, Ohio, 44035 USA  
Tel: (440) 366-5200  
Fax: (440) 366-5253  
[www.parker.com/hydraulicvalve](http://www.parker.com/hydraulicvalve)

Bulletin HY14-1610-M6/US,  
5/07