

Series D*1FP Servo Proportional Control Valves

Installation Guide

Bulletin HY14-2554-M1/US

aerospace
climate control
electromechanical
filtration
fluid & gas handling
hydraulics
pneumatics
process control
sealing & shielding



ENGINEERING YOUR SUCCESS.

Contents

	Page
Introduction.....	1 - 4
Safety Instructions	5
Important Details	5
Mounting / Installation.....	5 - 9
Operating Instructions	10
Maintenance	11
Troubleshooting	11
Accessories / Spare Parts	12
Repair / Service.....	12
Offer of Sale	II
Safety Guide	II



WARNING – USER RESPONSIBILITY

FAILURE OR IMPROPER SELECTION OR IMPROPER USE OF THE PRODUCTS DESCRIBED HEREIN OR RELATED ITEMS CAN CAUSE DEATH, PERSONAL INJURY AND PROPERTY DAMAGE.

- This document and other information from Parker-Hannifin Corporation, its subsidiaries and authorized distributors provide product or system options for further investigation by users having technical expertise.
- The user, through its own analysis and testing, is solely responsible for making the final selection of the system and components and assuring that all performance, endurance, maintenance, safety and warning requirements of the application are met. The user must analyze all aspects of the application, follow applicable industry standards, and follow the information concerning the product in the current product catalog and in any other materials provided from Parker or its subsidiaries or authorized distributors.
- To the extent that Parker or its subsidiaries or authorized distributors provide component or system options based upon data or specifications provided by the user, the user is responsible for determining that such data and specifications are suitable and sufficient for all applications and reasonably foreseeable uses of the components or systems.

OFFER OF SALE

The items described in this document are hereby offered for sale by Parker-Hannifin Corporation, its subsidiaries or its authorized distributors. This offer and its acceptance are governed by the provisions stated in the detailed "Offer of Sale" elsewhere in this document or available at www.parker.com/hydraulicvalve.

SAFETY GUIDE

For safety information, see Safety Guide SG HY14-1000 at www.parker.com/safety or call 1-800-CParker.

© Copyright 2008, Parker Hannifin Corporation, All Rights Reserved

Bul HY14-2554-M1.indd, dd



General Description

Series D*1FP pilot operated servo proportional valves transfer the advantages of the Parker patented Voice Coil Drive (VCD®) to larger frame sizes for high flow rates. The high dynamic / high precision drive of the pilot valve allows the optimum control of the main spool and results in servo performance of the complete valve.

Series D*1FP is available in 5 sizes:

- D31FP NG10 (CETOP 05)
- D41FP NG16 (CETOP 07)
- D81FP NG25 (CETOP 08)
for port diameter up to 26 mm (1.02 in.)
- D91FP NG25 (CETOP 08)
for port diameter up to 32 mm (1.26 in.)
- D111FP NG32 (CETOP 10)

The power down mode works with a safe 4th position of the D1FP pilot valve. This ensures that the main stage is hydraulically balanced at power down and allows the main spool spring to center (for overlapped spools), or approximately 10% spring offset to spool position A or B (for zerolap spools).

Features

- High dynamics
- High flow
- Defined spool positioning in case of power supply breakdown
- Onboard electronics
- Closed loop position – controlled pilot valve and main stage

Specifications

General				
Size	NG10 (CETOP 05)	NG16 (CETOP 07)	NG25 (CETOP 08)	NG32 (CETOP 10)
Mounting	DIN 24340 / ISO 4401 / CETOP RP121 / NFPA			
Mounting Position	Unrestricted			
Ambient Temperature Range	-20°C to +50°C (-4°F to +122°F)			

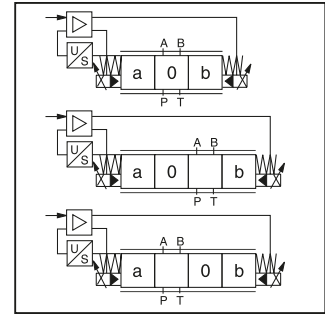

D41FP

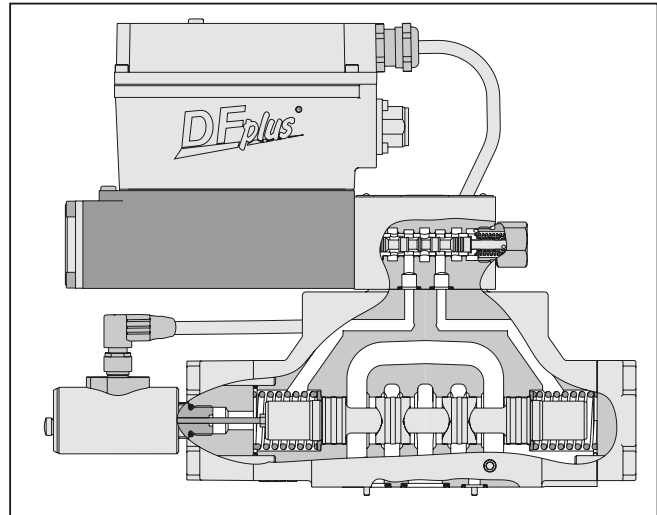

(Continued on next page)

Hydraulic		NG10 (CETOP 05)	NG16 (CETOP 07)	NG25 (CETOP 08)	NG32 (CETOP 10)
Maximum Operating Pressure		Internal Pilot Drain P, A, B, X: 350 Bar (5075 PSI); T, Y: 35 Bar (500 PSI) External Pilot Drain P, A, B, T, X: 350 Bar (5075 PSI); Y: 35 Bar (500 PSI)			
Fluid		Hydraulic oil as per DIN 51524 ... 51535, other on request			
Fluid Temperature		-20°C to +60°C (-4°F to +140°F)			
Viscosity Permitted		20 to 380 cSt (mm ² /s) (94 to 1727 SSU)			
Viscosity Recommended		30 to 80 cSt (mm ² /s) (140 to 375 SSU)			
Filtration		ISO Class 4406 (1999) 18/16/13 (acc. NAS 1638: 7)			
Nominal Flow at $\Delta p=5$ Bar (73 PSI)	per control edge ¹⁾	120 LPM (32 GPM)	200 LPM (53 GPM)	400 LPM (106 GPM)	1000 LPM (265 GPM)
Maximum Recommended Flow		250 LPM (66 GPM)	600 LPM (159 GPM)	1000 LPM (265 GPM)	3000 LPM (794 GPM)
Leakage at 100 Bar (1450 PSI)	Overlapped Spool	0.2 LPM (0.05 GPM)	0.2 LPM (0.05 GPM)	0.6 LPM (0.16 GPM)	1 LPM (0.26 GPM)
	Zerolapped Spool	0.9 LPM (0.24 GPM)	0.9 LPM (0.24 GPM)	1 LPM (0.26 GPM)	—
	Pilot	< 1 LPM (0.26 GPM)			
Pilot Supply Pressure		20 Bar (290 PSI) to 350 Bar (5075 PSI)			
Pilot Flow, Step Response at 210 Bar (3045 PSI)		10 LPM (2.6 GPM)	12 LPM (3.2 GPM)	24 LPM (6.3 GPM)	40 LPM (10.6 GPM)
Static / Dynamic					
Step Response at 100% Stroke		10 ms	13 ms	19 ms	45 ms
Frequency Response $\pm 5\%$ at 210 Bar (3045 PSI)		Amplitude 128 Hz 118 Hz	95 Hz 95 Hz	95 Hz 90 Hz	40 Hz 75 Hz
Hysteresis		< 0.1%			
Sensitivity		< 0.05%			
Temperature Drift		< 0.025%			
Electrical					
Duty Ratio		100%			
Protection Class		IP65 in accordance with EN 60529 (plugged and mounted)			
Supply Voltage / Ripple		22...30V, ripple < 0.5% eff., surge free			
Current Consumption		3.5 A maximum			
Switch on Current		22 A for 0.2 ms, typical			
Input Signal	Voltage	+10...0...-10V, ripple < 0.01% eff., surge free, 0...+10V P→A			
	Impedance	100k Ohm			
	Current	4...12...20 mA, ripple < 0.01% eff., surge free, 12...20 mA P→A < 3.6 mA = enable off, > 3.8 mA = enable on acc. NAMUR NE43			
	Impedance	250 Ohm			
Input Capacitance		1 nF, typical			
Differential Input Maximum	Code 0	30V for terminal D and E against PE (terminal G) 11V for terminal D and E against 0V (terminal B)			
	Code 5	30V for terminal 4 and 5 against PE (terminal \downarrow) 11V for terminal 4 and 5 against 0V (terminal 2)			
	Code 7	30V for terminal D and E against PE (terminal G)			
Enable Signal	Code 5/7	5...30V, R _i = 9 kOhm			
Diagnostic Signal		+10...0...-10V / +U _b , rated maximum 5 mA			
Pre-fusing		4.0 A medium lag			
EMC		EN 61000-6-2, EN 61000-6-4			
Electrical Connection	Code 0/7	6 + PE acc. EN 175201-804			
	Code 5	11 + PE acc. EN 175201-804			
Wiring Minimum	Code 0/7	7 x AWG16 overall braid shield			
	Code 5	8 x AWG16 overall braid shield			
Wiring Length		50 m (164 ft.) maximum			

¹⁾ Flow rate for different Δp per control edge: $Q_x = Q_{Nom.} \cdot \sqrt{\frac{\Delta p_x}{\Delta p_{Nom.}}}$

²⁾ Measured with load 210 Bar (3045 PSI) pressure drop; two control edges

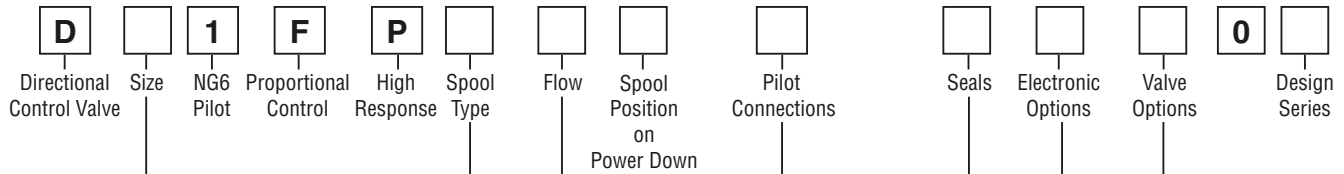

Code	Description
3	NG10 / CETOP 05
4	NG16 / CETOP 07
8	NG25 / CETOP 08
9 ¹⁾	NG25 / CETOP 08
11	NG32 / CETOP 10

¹⁾ for enlarged connections
 Ø 32 mm

Code	Inlet	Drain
1	Internal	External
2	External	External
4	Internal	Internal
5	External	Internal

Code	Description
N	Nitrile
V	Fluorocarbon
H	For HFC fluid

Code	Description
K	Voltage input 0...±10V
S	Current input 4...20mA

Code	Description
0	6+PE acc. EN175201-804
5	11+PE acc. EN175201-804
7	6+PE + Enable

Code	Spool Type
Overlap	
E01	
E02	
B31	$Q_B = Q_A / 2$
B32	$Q_B = Q_A / 2$
Zerolap	
E52 ²⁾	
B61 ²⁾	$Q_B = Q_A / 2$

²⁾ not for D111FP.

Code	Spool Position on Power Down ³⁾
A ⁴⁾	
B ⁴⁾	
C ⁵⁾	

³⁾ On power down the spool moves into a defined position.

⁴⁾ approx. 10% opening, only zero lapped spools.

⁵⁾ only for overlapped spools.

Code	Flow LPM (GPM) at Δp = 5 Bar (73 PSI) per metering edge			
	D31	D41	D81/91	D111
E	120 (32)	—	—	—
F	—	200 (53)	—	—
H	—	—	400 (106)	—
L	—	—	—	1000 (265)

Weight:

D31FP	11.3 kg (24.9 lbs.)
D41FP	14.2 kg (31.3 lbs.)
D81FP / D91FP	23.5 kg (51.8 lbs.)
D111FP	64.5 kg (142.2 lbs.)

Please order plugs separately.

Name Plate

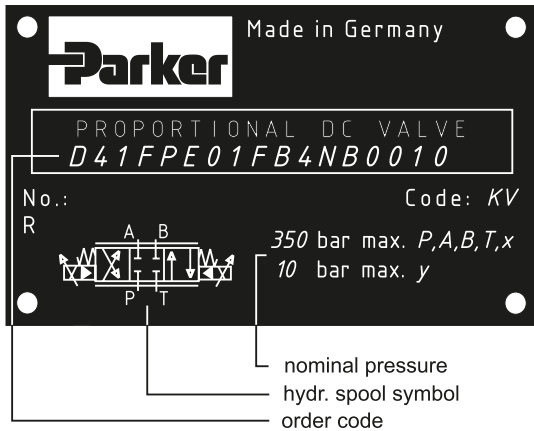

Parker D*1FP servo proportional control valves have integral electronics and require only one electrical common for the control system. Different flow sizes, fail-safe-functions as well as command signal options are available.

Description of Valve Driver

The integral electronic driver combines all necessary functions for the optimal operation of the valve. The excellent dynamics of the valve are ideal for closed loop control applications. The most important features are:

- high dynamic actuator and electronic driver
- closed loop controlled pilot valve and main spool
- constant current actuator control with overcurrent shutoff
- excellent properties for response sensitivity and temperature drift
- differential input stage with current / voltage command signal options
- diagnostic output for spool stroke / overcurrent state
- compatible to the relevant European EMC-standards

Block Diagram of Integral Electronics

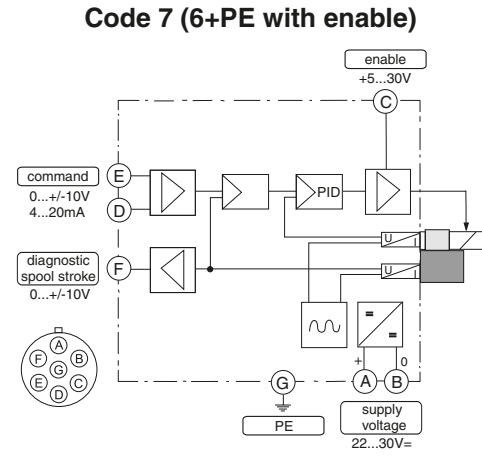
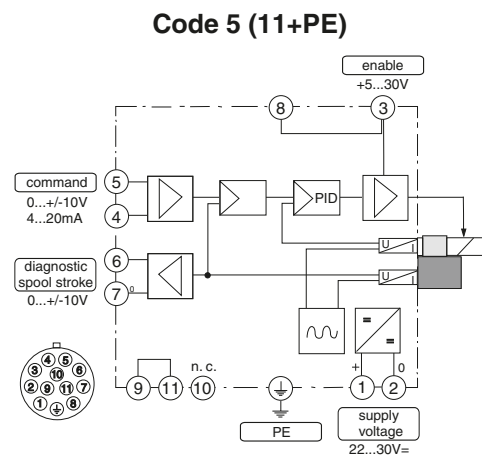
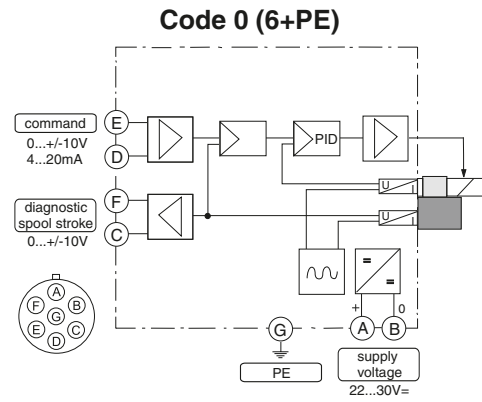



Safety Instructions

Please read the operation manual before installation, startup, service, repair or stocking! Paying no attention may result in damaging the valve or incorporated system parts.

Symbols

This manual uses symbols which have to be followed accordingly:

-  **Instructions with regard to the warranty**
-  **Instructions with regard to possible damaging of the valve or linked system components**
-  **Helpful additional instructions**

Marking, Name Plates

Instructions applied on the valve, i.e. wiring diagrams and name plates, must be observed and maintained legibly.

Work at the Valve

Workings in the area of installation, commissioning, maintenance and repair of the valve may only be allowed by qualified personnel. This means persons which have, because of education, experience and instruction, sufficient knowledge on relevant directives and approved technical rules.

Important Details

Intended Usage

This operation manual is valid for proportional directional control valves DF*plus* pilot operated series. Any different or beyond it usage is deemed to be as not intended. The manufacturer is not liable for warranty claims resulting from this.

Common Instructions

We reserve the right for technical modifications of the described product. Illustrations and drawings within this manual are simplified representations. Due to further development, improvement and modification of the product the illustrations might not match precisely with the described valve. The technical specifications and dimensions are not binding. No claim may result out of it. Copyrights are reserved.

Liability

The manufacturer does not assume liability for damage due to the following failures:

- incorrect mounting / installation
- improper handling
- lack of maintenance
- operation outside the specifications

 Do not disassemble the valve! In case of suspicion for a defect please return the valve to the factory.

Storage

In case of temporary storage the valve must be protected against contamination, atmospheric exposure and mechanical damages. Each valve has been factory tested with hydraulic oil, resulting in protection of the core parts against corrosion. This protection is only ensured under the following conditions:

Storage Period	Storage Requirements
12 months	Constant humidity < 60% as well as constant temperature < 25°C (77°F)
6 months	Varying humidity as well as varying temperature < 35°C (95°F)

 Outdoor storage or within sea and tropical climate will lead to corrosion and might disable the valve!

Mounting / Installation

Scope of Supply

Please check immediately after receiving the valve, if the content is matching with the specified scope of supply. The delivery includes:

- valve
- operation manual

The central connector assembly has to be ordered separately and is not included in the delivery.

 Please check the delivery immediately after receiving the shipment for apparent damages due to shipping. Report shipment losses at once to the carrier, the insurance company and the supplier!

Mounting

- Compare valve type (located on the name plate) with part list resp. circuit diagram.
 - No mounting restrictions.
 - Verify the mounting surface for the valve. Unevenness of 0.01 mm/100 mm, surface finish of 6.3 µm are tolerable values.
 -  Keep clean valve mounting surface and work environment!
 - Remove protection plate from the valve mounting surface
 - Check the proper position of the valve ports and the O-rings.
 - Mounting bolts:
 - D41FP: 2 pcs. M6X55 (1/4-20 x 2.25")
4 pcs. M10x60 (3/8-16 x 2.50")
 - D81FP: 6 pcs. M12x95 (1/2-13 x 3.75")
 - D111FP: 6 pcs. M20x90 (3/4-10 x 3.50")
- use property class 12.9, DIN 912 (Grade 8 SHCS)

(Continued on next page)

Mounting (continued)

- ☞ Parker offers bolt kits:
 - D41FP: BK320 (BK160)
 - D81FP: BK360 (BK228)
 - D111FP: BK 386 (BK150)
- Tighten the bolts crisscross with the following torque values:
 - D41FP: 13.2 / 63 Nm (9.7 / 46.5 lb.-ft.)
 - D81FP: 108 Nm (79.7 lb.-ft.)
 - D111FP: 517 Nm (381.3 lb.-ft.)

⚠ Insufficient condition of the valve mounting surface might create malfunction! Incorrect mounting resp. bolt torque may result in abrupt leakage of hydraulic fluid on the valve ports.

Operation Limits

The valve may be operated within the determined limits only. Please refer to the “technical data” section as well as to the “characteristic curves” in the catalog.

⚠ Follow the environmental conditions! Unallowable temperatures, shock load, aggressive chemicals exposure, radiation exposure, illegal electromagnetic emissions may result in erratic operation and may lead to failure! Follow the operating limits listed in the specifications table!

Pressure Fluids

The following rules applies for the operation with various pressure fluids:

⚠ The above information serves for orientation and does not substitute user tests among the particular operating conditions. Particularly no liability for media compatibility may be derived out of it.

Mineral Oil		Usable without Restriction
HFA	oil-in-water emulsion	consultation required
HFB	water-in-oil emulsion	consultation required
HFC	aqueous solution (glycols)	consultation required
HFD	anhydrous fluids (Phosphor-Ester)	consultation required

☞ For detailed information concerning pressure fluids note VDMA-document 24317 as well as DIN 51524 & 51502. Special gaskets may be available depending on the utilized fluid. In case of insecurity please consult the factory.

Electrical Connection

The electrical connection of the valve takes place by one common cable, which is coupled to the integrated electronic driver by a central connector assembly.

The connection Code 0 as well as Code 7 requires a 6 + PE female connector EN 175201-804.

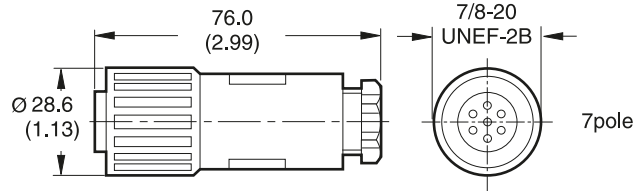

☞ The female connector has to be ordered separately under article nr. 5004072.

⚠ A female connector with metal housing is required! Plastic made models may create function problems due to insufficient EMC-characteristics.

The connecting cable has to comply to the following specification:

- Cable type: control cable, flexible, 7 conductors, overall braid shield
- Cross section: min. AWG16
- Outer dimension: 8-12 mm (0.31-0.47 in.)
- Cable length: max. 50 m (164 ft.)

☞ For cable lengths > 50 m (164 ft.) consult factory.

The connection cable is coupled to the female connector by solder joints.

Skinning lengths for the connecting cable:



The connection Code 5 requires a 11 + PE female connector EN 175201-804.

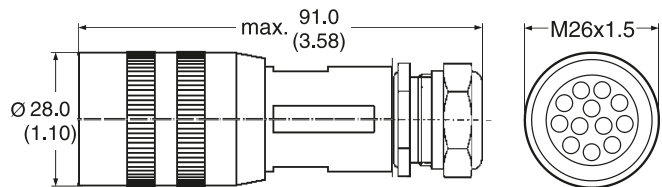

☞ The female connector has to be ordered separately under article nr. 5004711.

⚠ A female connector with metal housing is required! Plastic made models may create function problems due to insufficient EMC-characteristics.

(Continued on next page)

Electrical Connection (continued)

The connecting cable has to comply to the following specification:

- Cable type control cable, flexible, 7 conductors, overall braid shield
- Cross section min. AWG16
- Outer dimension 12-15 mm (0.47-0.59 in.)
- Cable length max. 50 m (164 ft.)
- ☞ For cable lengths > 50 m (164 ft.) consult factory.

The connection cable is coupled to the female connector by crimp contacts.

Skinning lengths for the connecting cable:

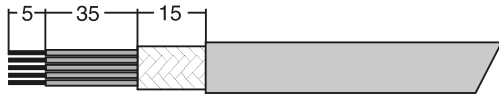

☞ For the workmanlike termination of the crimp contacts the tool # 932 507-001 – supplier: Hirschmann – is required.

⚠ Do not disconnect cable socket under tension!

The shielding has to be assembled according the outline below:

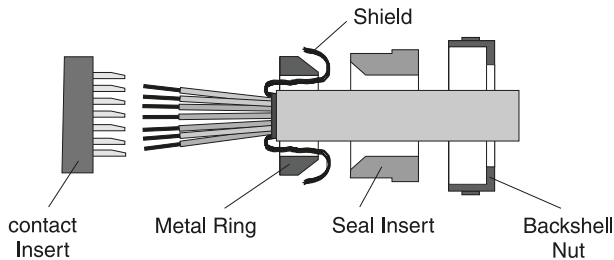

The backshell nut of the cable gland has to be tightened with a suitable tool. The target value for the tightening torque is 4 Nm (3.0 lb.-ft.). Tighten the cap nut with a torque of approx. 5 Nm (3.7 lb.-ft.) after attaching the female connector on the socket outlet.

⚠ Incomplete tightening of backshell nut resp. cap nut may result in automatic release of the connection as well as degradation of the water tightness.

Follow the “instructions for use” for installation of female connectors made by other kind of brands!

⚠ The cable connection to the female connector has to take place by qualified personnel! A short between individual conductors resp. to the connector housing, bad soldering as well as improper shield connection may result in malfunction and breakdown of the valve.

⚠ The mounting surface of the valve has to be carefully tied to the earth grounded machine frame. The earth ground wire from the valve connecting cable as well as the cable shield have to be tied to the protective earth terminal within the control unit. It is necessary to use a low ohmic potential connection between control unit and machine frame to prevent earth loops (cross section AWG 6).

Electrical Interfacing

Supply Voltage:

The supply voltage for the valve has to cover the range of 22...30V. The residual ripple may not exceed 5% eff.

⚠ The applied power supply must comply to the relevant regulations (DIN EN 61558) and must carry a CE-mark. The operating voltage for the valve must be free of inductive surges. Do not exceed the max. value of 30V! Non-observance of this rule may result in permanent damaging of the valve.

⚠ The increased inrush current of the valve should be considered when selecting the power supply. A stabilized power supply with overcurrent limiting feature should not be used. Due to the inrush current of the valve the current limit circuit may respond prematurely and create problems during energizing of the supply voltage.

⚠ The operation of the valve is blocked if the supply voltage polarity is interchanged.

⚠ Each valve requires a separate pre-fuse of 4 Amp time lag. Non-observance of this instruction may create irreparable damage of valve resp. incorporated system parts.

Wiring Diagram of Supply Voltage

Code 0 (6 + PE)

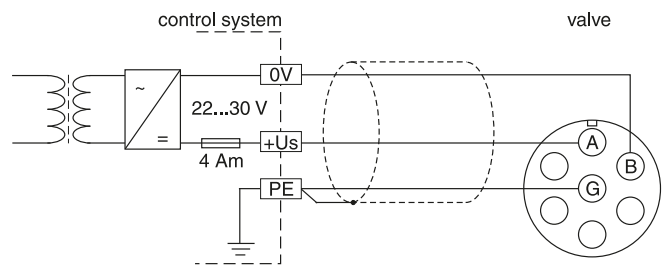

Code 5 (11 + PE)

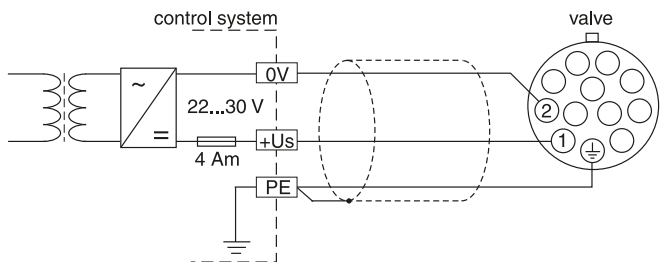

Code 7 (6 + PE)

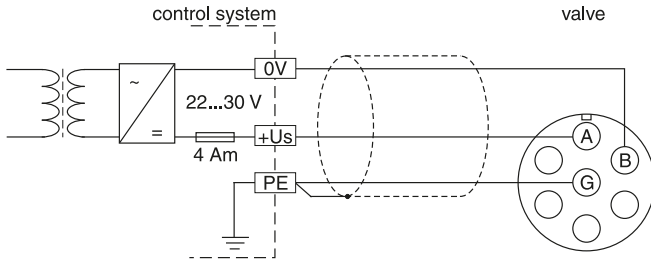

Enable input (only for Code 5 / 11+PE as well as Code 7 / 6+PE)

A signal voltage enables the actuator drive of the valve. Continuous operation of the valve requires a permanent voltage 5...30V (i.e. the supply voltage). When the enable signal is removed the valve will reach its hydraulic default (fail safe) position independently from the command signal value. At the same time the position controller output will be clamped. In the case of restarting the enable signal, the valve spool takes its position always out of the fail safe position. It is preferred that the enable signal should be switched on together with the hydraulic pressure supply. This forces the actuator drive into drop out condition when the hydraulic system is switched off, and it avoids needless heating of the actuator.

! The enable function does not guarantee unwanted valve operation in terms of rules for accident prevention! To block the valve function under all conditions, more advanced steps are necessary, i.e. the installation of additional safety check valves.

Wiring Diagram of Enable Input

Code 5 (11 + PE)

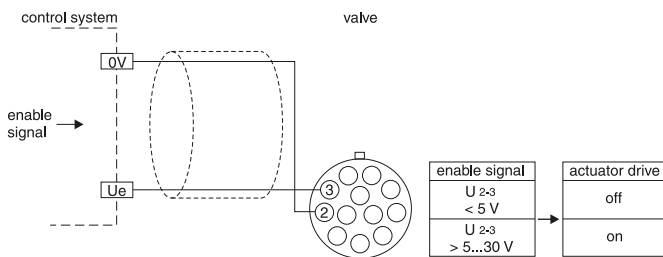

Code 7 (6+PE)

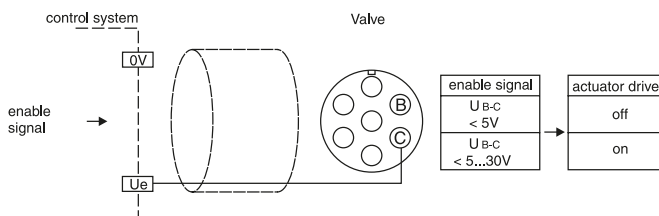

Command signal input:

The command signal for the valve will be connected to the pins D and E of the difference signal input of the electronic driver. The spool stroke responds proportional to the command signal. Different versions of command signal processing are available, depending on the valve type. These are described below:

For the function description is assumed as signal reference (0V):

Code 0: pin E, Code 5: pin 5, Code 7: pin E

! Details are shown from the technical specifications.

! The command input signal needs to be filtered as well as free of inductive surges and modulations. Due to the sensitivity of the valve a high signal quality is recommended, this will prevent malfunction.

! Incorrect signal amplitude levels may disturb the functionality and can damage the valve.

! The option 4...20 mA uses the "0 mA" condition as breakdown-information. This means the presence of an evaluable failure information if the input signal line is interrupted. In this case the actuator drive will be switched off. The drive will switch on when the input signal reaches a value of 3.8 mA, it switches off when the command falls below 3.6 mA. This determination follows the NAMUR-specification NE43.

NAMUR is an association of users of process control technology.

**Wiring Diagram of Voltage Command Input
 +10...0...-10V**

Code 0 (6 + PE)

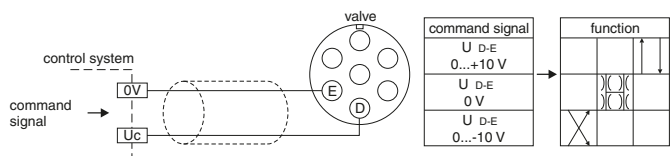

**Wiring Diagram of Voltage Command Input
 +10...0...-10V**

Code 5 (11 + PE)

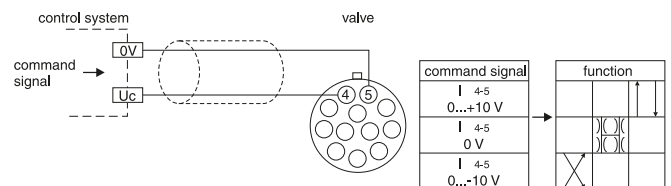

**Wiring Diagram of Voltage Command Input
 +10...0...-10V**

Code 7 (6 + PE)

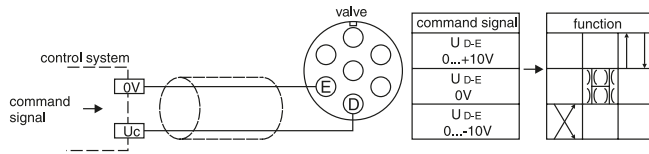

**Wiring Diagram of Current Command Input
 4...12...20 mA**

Code 0 (6 + PE)

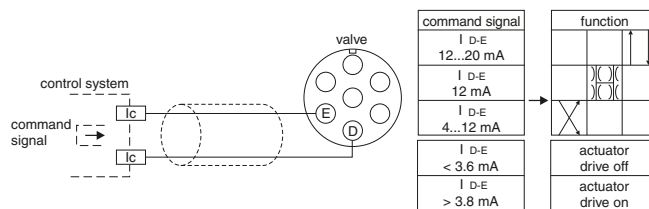

**Wiring Diagram of Current Command Input
 4...12...20 mA**

Code 5 (11 + PE)

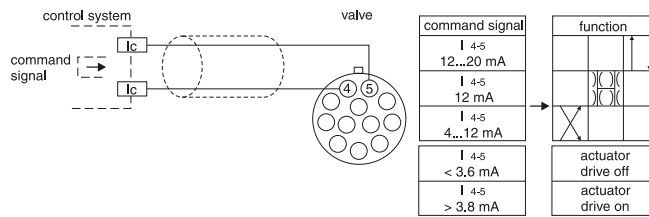

**Wiring Diagram of Current Command Input
 4...12...20 mA**

Code 7 (6 + PE)

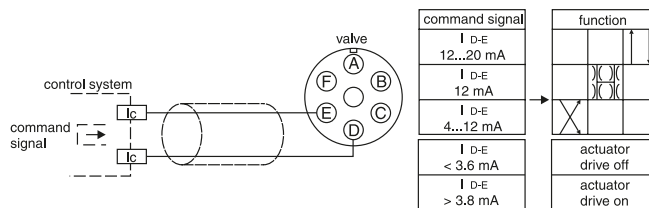

Diagnostics output:

A diagnostics signal is available. Its voltage represents the operating condition of the valve.

The following information is available:

- position of valve spool (+10...0...-10V means +100...0...-100 % spool stroke).
- status of the actuator drive (supply voltage level +22...30V for disconnected drive due to overload condition).

⚠ The output may drive a load of max. 5 mA. Exceeding of this limit leads to malfunction.

Wiring Diagram of Diagnostics Output

Code 0 (6 + PE)

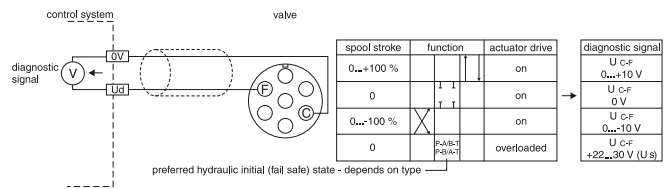

Wiring Diagram of Diagnostics Output

Code 5 (11 + PE)

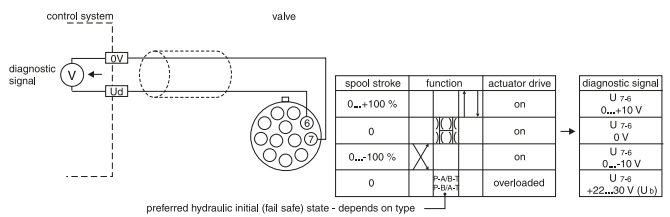

Wiring Diagram of Diagnostics Output

Code 7 (6 + PE)

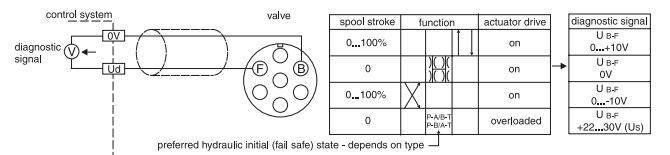

Operating Instructions

Basically the valve performs the task of converting a command signal into a proportional spool stroke with the highest possible precision. For these purposes the input value will be electronically compared with the actual spool position value. The signal difference feeds a position controller, that in turn provides via a power amplifier stage the required current for the actuator of the pilot stage.

Preferred Hydraulic Initial State

 Valve versions with zero lap spool have no safe initial state when switched off. In this case the valve takes a position which is selectable by the valve type (preferred hydraulic initial state). This position depends on contamination level and therefore is not ensured. We would therefore recommend the application of additional logic valves with sequential control.

Solenoid Current Monitoring

The electronic driver contains a circuit to monitor the solenoid current. The current measurement compares for exceeding of a certain value and switches off after a time period of approx. 10 sec. for temperature rise protection of the actuator. For normal operating conditions this state will not be reached, but it may occur with a contaminated sluggish valve.

 In this case the reason for the contamination should be addressed (hydraulic fluid exchange, filtration review, valve flushing).

The overcurrent shutoff condition may be reset by the actions below:

Code 0: Temporary disconnection of the supply voltage.

Code 5: Temporary disconnection of the enable signal.

Code 7: Temporary disconnection of the enable signal.

 The shutoff of the actuator drive due to overload will be signaled via the diagnostics output.

The condensed function conditions of the actuator drive are given below:

The actuator drive is enabled, if:

the actuator drive is in normal operation, AND current of > 3.8 mA flows into input (4...20 mA option only)

The actuator drive is disabled, if:

the actuator drive is in overload operation, OR current of < 3.6 mA flows into input (4...20 mA option only)

Air Bleeding of Hydraulic System

During initial startup, after an oil change as well as after the opening of lines or valves the hydraulic system must be air bled. Air in the hydraulic system is very disadvantageous and therefore undesirable for the control system. The pipeline network is vented at its highest point. The fitting may be loosened a little so that the air can escape with only a small amount of oil loss. When the oil is no longer foaming, the fitting is retightened. Afterwards all functions are run through, one after the other, in no-load operation with low pressure and with full cylinder stroke. Afterwards the system should be vented once more.

 After air bleeding the oil level in the tank must be checked, and refilled as necessary!

Filter

The function and lifetime of the valve are strongly affected by the cleanliness of the fluid.

 Dirt is the greatest enemy of the hydraulic system!

There are three important sources of dirt to watch for:

- contamination arising during installation
- contamination arising during operation, friction wear
- impurities from the environment

Basically a purity level class of 7 acc. NAS 1638 is required.

 Pay attention to maintenance details!

Flushing

It is recommended to flush the long pipelines by short circuiting the pressure and return lines, especially for large, central pressure oil stations. This prevents the installation dirt from entering the valve.

Maintenance

 Service work may only be carried out by qualified personnel. Detailed knowledge of the machine functions concerning switching on and off as well as of the required safety relevant technical tasks is required!

Periodical maintenance is essential for the longevity of the system and guarantees reliability and availability. The following properties of the system have to be checked in continuous short time intervals:

- oil level in the tank
- max. working temperature
- condition of the pressure fluid (visual inspection, color and smell of hydraulic fluid)
- working pressure levels
- gas pre-load pressure on the pressure accumulator
- leakage on all system components
- condition of filter elements
- condition of hose lines
- cleanliness of components

After a certain operating duration a change of the hydraulic fluid is required. The frequency of change depends from the following circumstances:

- fluid type
- filtration quality
- operating temperature and environmental conditions

Troubleshooting

Basis of troubleshooting is always a systematic approach. At first the following questions have to be checked:

- Are there practical experiences with similar failures?
- Have system adjustments been changed?

Begin troubleshooting by means of a priority list of the most likely reasons.

 For suspect of a sluggish spool the valve may be flushed with clean pressure fluid.

 Troubleshooting in a hydraulic system requires a systematic approach. The work should be performed by qualified personnel, as it requires detailed knowledge about function and construction of the system.

Malfunction at Hydraulic Load Runtime										
									- generally no function	
									- high frequent oscillation	
									- low frequent oscillation	
									- one way operation only	
									- speed variations at unchanging command	
									- different speeds depending on travel direction	
									- speed too low	
									- drifting without command	
									- poor dynamic	
									Possible Reasons for Malfunction	Corrective Actions
X									hydraulic pump resp. motor defective	replace hydraulic pump resp. motor
X		X	X	X	X	X		X	drive overloaded	reduce pressure resp. speed, increase valve size
X		X	X	X	X	X	X	X	valve contaminated	clean pressure fluid, filter / flush valve
					X			X	hydraulic fluid too viscous / too cold	change fluid grade, provide operational temperature
X		X	X						too low oil level within tank	refill pressure fluid
				X	X	X			filter contaminated	clean resp. replace filter
X		X				X	X		supply voltage too low	keep supply voltage range
	X								supply voltage carries too much ripple	reduce ripple
X			X			X			command signal too low	increase command signal
	X								command signal carries too much ripple	reduce ripple
			X		X				center position adjustment incorrect	check center position adjustment
X	X			X		X	X		contacts of central connector contaminated	clean contacts / replace plug
X									feed cable interrupted	fix feed cable
X	X	X	X	X		X	X		wiring sequence incorrect	correct wiring sequence
	X							X	feed cable without shielding	change cable grade
X									pilot pressure too low or failed	increase pilot pressure to min. 20 bar
		X				X	X		pilot pressure too low	increase pilot pressure to min. 20 bar
								X	pilot pressure too low	increase pilot pressure to min. 50 bar

Bul HY14-2554-M1.indd, dd

Accessories / Spare Parts

Accessories

The following accessories are available for the valve series DF Plus pilot operated:

D41FP

Bolt Kit	ordering code BK320 (BK160)
Code 0: female connector 6+PE	ordering code 5004072
Code 5: female connector 11-PE	ordering code 5004711
Code 7: female connector	ordering code 5004072

D81FP

Bolt Kit	ordering code BK360 (BK228)
Code 0: female connector 6+PE	ordering code 5004072
Code 5: female connector 11-PE	ordering code 5004711
Code 7: female connector	ordering code 5004072

D111FP

Bolt Kit	ordering code BK386 (BK150)
Code 0: female connector 6+PE	ordering code 5004072
Code 5: female connector 11-PE	ordering code 5004711
Code 7: female connector	ordering code 5004072

Spare Parts

The following spare parts are available:

D41FP

Seal Kit NBR	ordering code SK-D41FH-N35
--------------	-------------------------------

D81FP

Seal Kit NBR	ordering code SK-D81FH-N35
--------------	-------------------------------

D111FP

Seal Kit NBR	ordering code SK-D111FH-N35
--------------	--------------------------------

Repair / Service

When you buy a Parker component, full technical support from Parker After Sales Service is included.

Our highly qualified team will be glad to assist you in all industrial and mobile applications.

For further questions please contact us:

Parker Hannifin Corporation

Hydraulic Valve Division
520 Ternes Avenue
Elyria, OH 44035 USA
Tel.: 440-366-5200
Fax: 440-366-5253
www.parker.com/hydraulicvalve

We offer full service:

- general support for starting up Parker hydraulic controls.
- maintenance of Parker controls.
- repair of all Parker related hydraulic and electrical devices.
- assistance in the supply of spare parts worldwide.
- technical training in theory and practice.

Extensive Hydraulic Product Offering

Accumulators



Piston, bladder and diaphragm type accumulators, gas bottles and KleenVent reservoir isolators.

www.parker.com/accumulator

Compact Hydraulics



Self-contained with a motor, gear pump, reservoir, internal valving, load hold checks and relief valves.

www.parker.com/oildyne

Cylinders



Standard and custom hydraulic cylinders for industrial and mobile applications.

www.parker.com/hydcyl

Electronics/Remote Controls



Parker's unique IQAN approach combines sturdy, well-tested hardware with intelligent, flexible computing power.

www.parker.com/iqan

Filtration



Pressure and return line filters enhances machine life, reduces maintenance and lowers costs.

www.parker.com/hydraulicfilter

Integrated Hydraulic Circuits

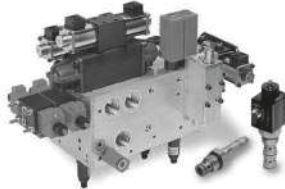

Solutions for complex circuits that include threaded cartridge valves integrated into a single manifold.

www.parker.com/ihd

Motors



Full line of high and low speed motors provides power up to 15,000 in-lbs of torque.

www.parker.com/pumpmotor

Power Take Off



Parker Chelsea leads the industry for engineering, innovation and performance in auxiliary power systems.

www.parker.com/chelsea

Power Units



The most complete line of standard, pre-engineered, cataloged hydraulic power units in the industry.

www.parker.com/pumpmotor

Pumps



Broad line of energy-efficient hydraulic pumps that includes piston, vane and gear pumps.

www.parker.com/mobpump

Rotary Actuator



Industry leader in the design and manufacture of hydraulic rack and pinion, and vane style rotary actuators.

www.parker.com/actuator

Valves and Controls



Hydraulic valves for virtually every hydraulic equipment application, from simple to precise control.

www.parker.com/hydraulicvalve

Covering the Industrial, Mobile and Truck markets, each catalog is paired with an interactive CD. Call for your comprehensive guides today. 1-800-CParker



*Mobile Bulletin
HY19-1001/US*

*Industrial Bulletin
HY01-1001/US*

*Truck Bulletin
HY19-1004/US*

Parker Hydraulics International Sales Offices

North America

Hydraulics Group Headquarters
6035 Parkland Boulevard
Cleveland, OH 44124-4141 USA
Tel: 216-896-3000
Fax: 216-896-4031

**Parker Hannifin Canada
Motion & Control Division – Milton**
160 Chisholm Drive Milton
Ontario Canada L9T 3G9
Tel: 905-693-3000
Fax: 905-876-1958

Mexico

Parker Hannifin de México
Av eje uno norte num 100
Parque Industrial Toluca 2000
Toluca, Mex C.P. 50100
Tel: 52 722 2754200
Fax: 52 722 2799308

Europe

**Europe Hydraulics Group
Parker Hannifin Corporation**
Parker House
55 Maylands Avenue
Hemel Hempstead, Herts
HP2 4SJ England
Tel: 44 1442 458000
Fax: 44 1442 458085

Latin America

Brazil

**Hydraulics Division
Parker Hannifin Ind. e Com. Ltda**
Av. FredericoRitter, 1100
Cachoeirinha RS, 94930-000 Brazil
Tel: 55 51 3470 9144
Fax: 55 51 3470 3100

Pan American Division

7400 NW 19th Street, Suite A
Miami, FL 33126 USA
Tel: 305-470-8800
Fax: 305-470-8808

Mobile Sales

**Mobile Sales Organization
and Global Sales**
595 Schelter Road
Suite 100
Lincolnshire, IL 60069 USA
Tel: 847-821-1500
Fax: 847-821-7600

Industrial Sales

Great Lakes Region
3700 Embassy Parkway
Suite 260
Fairlawn, OH 44333 USA
Tel: 330-670-2680
Fax: 330-670-2681

Southern Region

1225 Old Alpharetta Road
Suite 290
Alpharetta, GA 30005 USA
Tel: 770-619-9767
Fax: 770-619-9806

Chicago Region

1163 E. Ogden Avenue
Suite 705, #358
Naperville, IL 60563 USA
Tel: 630-964-0796
Fax: 866-473-9274

Pacific Region

8460 Kass Drive
Buena Park, CA 90621 USA
Tel: 714-228-2510
Fax: 714-228-2511

Eastern Region

100 Corporate Drive
Lebanon, NJ 08833 USA
Tel: 908-236-4121
Fax: 908-236-4146

Gulf Region

20002 Standing Cypress Drive
Spring, TX 77379 USA
Tel: 317-519-8490
Fax: 866-390-4986

Asia Pacific

**Asia Pacific Headquarters
Parker Hannifin Hong Kong Ltd**
8/F, Kin Yip Plaza
9 Cheung Yee Street
HK-Cheung Sha Wan, Hong Kong
Tel: 852 2428 8008
Fax: 852 2425 6896

Australia Headquarters Parker Hannifin Pty Ltd.

9 Carrington Road
Castle Hill, NSW 2154, Australia
Tel: 612 9634 7777
Fax: 612 9842 5111

China Headquarters

**Parker Hannifin Motion & Control
(Shanghai) Co., Ltd**
280 Yunqiao Road,
Jin Qiao Export Processing Zone
CN-Shanghai 201206, China
Tel: 86 21 5031 2525
Fax: 86 21 5834 3714

Korea Headquarters

Parker Hannifin Korea Ltd
6F Daehwa Plaza
169 Samsung-dong, Gangnam-gu
KR-Seoul, 135-090, Korea
Tel: 82 2 559 0400
Fax: 82 2 556 8187

South Africa

Parker Hannifin Africa Pty Ltd Parker Place

10 Berne Avenue Aeroport
P.O. Box 1153
ZA-Kempton Park 1620,
Republic of South Africa
Tel: 27 11 961 0700
Fax: 27 11 392 7213

Middle East

Egypt

Parker Hannifin Corporation
8B Zahraa Maadi
Region 17F
Cairo, Egypt
Tel: (20) 2 5194018
Fax: (20) 2 5190605

Bulletin HY14-2554-M1/US,
2M, 7/08



Parker Hannifin Corporation Hydraulic Valve Division

520 Ternes Avenue
Elyria, Ohio 44035 USA
Tel: 440-366-5200
Fax: 440-366-5253
www.parker.com/hydraulicvalve

Your Local Authorized Parker Distributor