



Bulletin HY11-5715-593/UK

# Operation Manual



---

## Proportional Valves for External Electronics

---

**Parker Hannifin**  
**Manufacturing Germany GmbH & Co. KG**  
Hydraulic Controls Division Europe  
Gutenbergstr. 38  
41564 Kaarst, Germany  
Tel.: (+49) 181 99 44 43 0  
E-mail: [infohcd@parker.com](mailto:infohcd@parker.com)  
Copyright © 2013, Parker Hannifin Corp.

**Note**

This document and other information from Parker-Hannifin Corporation, its subsidiaries and authorized distributors provide product or system options for further investigation by users having technical expertise.

The user, through its own analysis and testing, is solely responsible for making the final selection of the system and components and assuring that all performance, endurance, maintenance, safety and warning requirements of the application are met. The user must analyze all aspects of the application, follow applicable industry standards, and follow the information concerning the product in the current product catalog and in any other materials provided from Parker or its subsidiaries or authorized distributors.

To the extent that Parker or its subsidiaries or authorized distributors provide component or system options based upon data or specifications provided by the user, the user is responsible for determining that such data and specifications are suitable and sufficient for all applications and reasonably foreseeable uses of the components or systems.

**Operation Manual**

Index	Page
<b>1. Introduction</b>	<b>4</b>
Order Code	4
Name Plate	5
Connections with the Electronics	5
Characteristics of Valves	5
Specifications	6
<b>2. Safety Instructions</b>	<b>7</b>
Symbols	7
Marking, Name Plates	7
Work at the Valve	7
<b>3. Important Details</b>	<b>7</b>
Intended Usage	7
Common Instructions	7
Liability	7
Storage	7
<b>4. Mounting / Installation</b>	<b>8</b>
Scope of Supply	8
Mounting	8
Operation Limits	8
Pressure Fluids	8
Electrical Connection	9
<b>5. Operation Instructions</b>	<b>11</b>
Electronic Control Unit	11
Solenoid Selection	11
Air Bleeding of Hydraulic System	11
Filter	11
Flushing	11
<b>6. Maintenance</b>	<b>12</b>
<b>7. Trouble-Shooting</b>	<b>13</b>
<b>8. Repair / Service</b>	<b>13</b>

# Operation Manual

## 1. Introduction

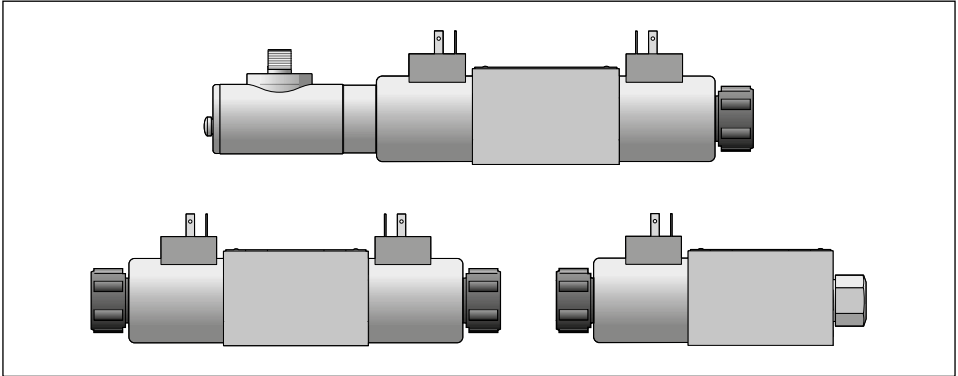

### Order Code

Each valve carries a name plate with the order code indicating the definite valve type. The meaning of the individual characters can be taken from the corresponding catalog sheet of the valve.

Example:

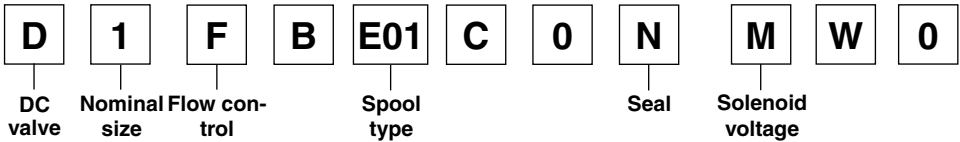

## Operation Manual

Parker proportional valves are available with and without integrated electronics. In the latter case an external electronic is required, which matches the characteristics of the valve. Parker provides an optimal tuned electronic for each valve equipped with different operating and configuring options.

### Characteristics of Valves

Parker proportional valves show all attributes which are essential for optimal and trouble-free operation under industrial conditions:

- excellent valve characteristics
- driven by modern DC-proportional solenoids
- optional with contactless position measuring of spool stroke via inductive sensor
- hydraulic connection via standard mounting interface
- electrical connection via standard connectors

### Name Plate

Example:

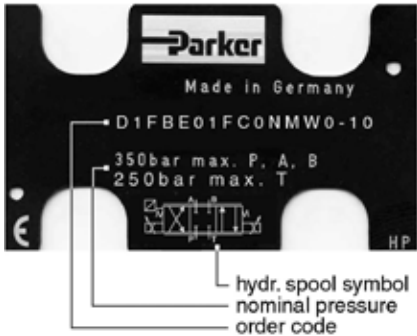

### Connections with the Electronics

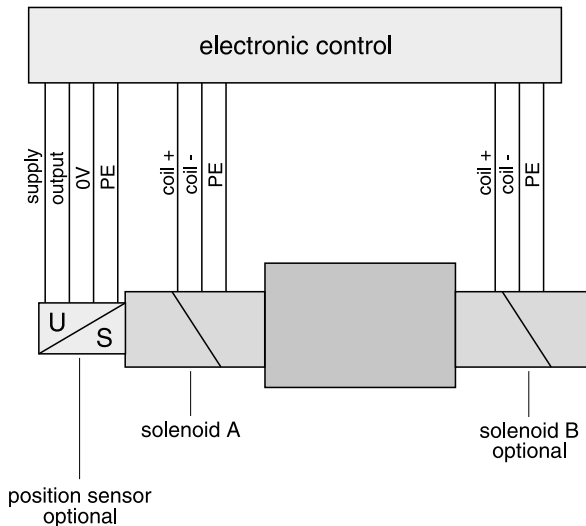

# Operation Manual

## Specifications

General		
Model	[bar]	See catalog
Drive		Proportional solenoid
Installation position		Any
Ambient temperature range	[°C]	-20...+50
Protection class		NEMA 4 (IP 65) acc. EN 60529
Vibration strength	[g]	10 Sinus 5...2000 Hz acc. IEC68-2-6 30 Random noise 20...2000 Hz acc. IEC68-2-36 15 Shock acc. IEC68-2-27
Hydraulic		
Fluid rate		Hydraulic oil acc. DIN 51524...535, other on request
Viscosity	[mm <sup>2</sup> /s]	30...80 (max. 20...380)
Fluid temperature	[°C]	-20...+60
Cleanliness class		18/16/13 acc. to ISO 4406, X = 10 μm (β <sub>10</sub> > 75) ISO 4572
Operating pressure max.	[bar]	See catalog
Electrical		
Duty ratio	[%]	100
Solenoid	[VDC]	
Supply voltage	[A]	See catalog
Current consumption		See catalog
Connection	[mm <sup>2</sup> /s]	2 + PE acc. EN 175301-803
Connection cable		3 x 1.5 (AWG 16) overall braid shield
Insulation class		F (155°C)
Sensor (optional)		
Supply voltage	[VDC]	18...30, ripple < 5% eff., surge free
Current consumption	[A]	< 60 mA
Connection		4 + PE acc. IEC 61076-2-101 (M12)
Connection cable	[mm <sup>2</sup> ]	4 x 0.5 (AWG 20) overall braid shield
EMC		EN 50081-2, EN 50082-2
Cable length max.	[m]	50

## Operation Manual

### 2. Safety Instructions

Please read the operation manual before installation, start-up, service, repair or stocking! Paying no attention may result in damaging the valve or incorporated system parts.

#### Symbols

This manual uses symbols which have to be followed accordingly:



**Instructions with regard to the warranty**



**Instructions with regard to possible damaging of the valve or linked system components**



**Helpful additional instructions**

#### Marking, Name Plates

Instructions applied on the valve, i.e. wiring diagrams and name plates, must be observed and maintained legibly.

#### Work at the Valve

Working in the area of installation, commissioning, maintenance and repair of the valve may only be allowed by qualified personnel. This means persons who due to education, experience and instruction, have sufficient knowledge of relevant directives and approved technical rules.

### 3. Important Details

#### Intended Usage

This operation manual is valid for proportional valves without integrated electronics. Any use diverging or going beyond is deemed to be as not intended. The manufacturer is not liable for warranty claims resulting from this.

### Common Instructions

We reserve the right of technical modifications of the described product. Illustrations and drawings within this manual are simplified representations. Due to further development, improvement and modification of the product, the illustrations might not match precisely with the described valve. The technical specifications and dimensions are not binding. No claim may result from it. Copyrights reserved.

#### Liability

The manufacturer does not assume liability for damage due to the following failures:

- incorrect mounting / installation
- improper handling
- lack of maintenance
- operation outside the specifications



Do not disassemble the valve! In case of suspicion for a defect please return the valve to the factory.

#### Storage

In case of temporary storage the valve must be protected against contamination, atmospheric exposure and mechanical damages. Each valve has been factory tested with hydraulic oil, resulting in protection of the core parts against corrosion. Yet this protection is only ensured under the following conditions:

Storage period	Lagerbedingungen
12 months	constant humidity < 60% as well as constant temperature < 25°C
6 months	varying humidity as well as varying temperature < 35°C



Outdoor storage or within sea and tropical climate will lead to corrosion and might disable the valve!

## Operation Manual

### 4. Mounting / Installation

#### Scope of Supply

Please check immediately after receiving the valve if the content is matching with the specified scope of supply.

The delivery includes:

- valve
- operation manual

The required connector assemblies has to be ordered separately and are not included in the delivery.

 Please check the delivery immediately after receiving the shipment for apparent damages due to shipping. Report shipment losses at once to the carrier, the insurance company and the supplier!

#### Mounting

- Compare valve type (located on the name plate) with part list resp. circuit diagram.
- The valve may be mounted fix or movable in any direction.
- Verify the mounting surface for the valve. Unevenness of 0.01 mm/100 mm, surface finish of 6.3 µm are tolerable values.

 Keep clean valve mounting surface and work environment!

- Remove protection plate from the valve mounting surface.
- Check the proper position of the valve ports and the O-rings.
- Use mounting bolts acc. catalog specification, property class 12.9, DIN 912.

 Parker offers suitable bolt kits, order number acc. to catalog.

- Tighten the bolts crisscross, torque acc. to catalog specification.

 Insufficient condition of the valve mounting surface might create malfunction! Incorrect mounting resp. bolt torque may result in abrupt leakage of hydraulic fluid on the valve ports.

#### Operation Limits

The valve may be operated within the determined limits only. Please refer to the "technical data" section as well as to the "characteristic curves" in the catalog.

 Follow the environmental conditions! Unallowable temperatures, shock load, aggressive chemicals exposure, radiation exposure, illegal electromagnetic emissions may result in operating trouble and may lead to failure! Follow the operating limits listed in the "specifications" table!

#### Pressure Fluids

The following rules applies for the operation with various pressure fluids:

Mineral oil		Usable without restriction
HFA	oil-in-water emulsion	consultation required
HFB	water-in-oil emulsion	consultation required
HFC	aqueous solution (glycols)	possibly restrictions, consultation recommended
HFD	unhydrous fluids (Phosphor-Ester)	possibly restrictions, consultation recommended

 The above information serves your orientation and does not substitute user tests among the particular operating conditions. Particularly no liability for media compatibility may be derived from it.

 For detailed information concerning pressure fluids note VDMA-document 24317 as well as DIN 51524 and 51502. Special gaskets may be available depending on the utilized fluid. When insecure, please consult the factory.



## Operation Manual

### Electrical Connection

The electrical connection of the valve takes place by separate cables for solenoids resp. position sensor.

#### Solenoid connection:

Each solenoid requires one connector assembly 2 + PE acc. to EN 175301-803.

☞ The connector assemblies have to be ordered separately.

#### Available types

Thread	Color	Imprint	Order no.
PG9	grey	A	5001711
PG9	black	B	5001710
PG11	grey	A	5001717
PG11	black	B	5001716

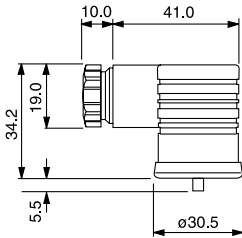

⚠ The applied connector assemblies may not contain adaptive circuits, as signal lamps or recovery diodes, otherwise malfunctions and irreparable damages may occur on the electronic control unit!

#### Connection of the female connector assembly

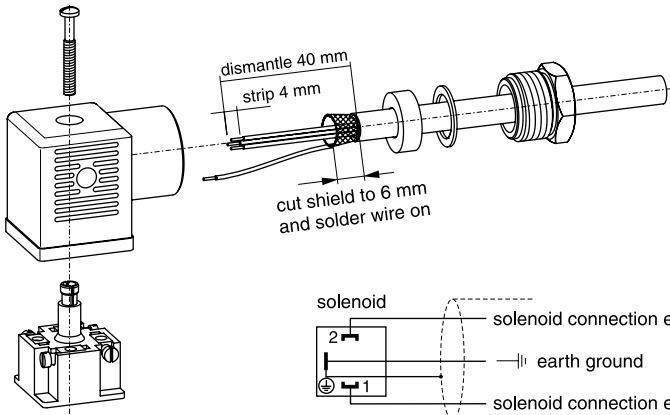

The connection cable has to comply to the following specification:

Cable type: control cable, flexible, 3 conductors, overall braid shield  
 Cross section: min. 1.5 mm<sup>2</sup> (AWG 16)  
 Outer dimension: PG9: 4.5...7 mm / PG11: 6...9 mm  
 Cable length: max. 50 m

☞ For cable lengths > 50 m consult factory.

⚠ The mounting surface of the valve has to be carefully tied to the earth grounded machine frame. The earth ground wires as well as the cable shields have to be tied to the protective earth terminal within the control unit.

The connection cable will be coupled to the connector assembly via terminal screws.

The backshell nut of the cable gland has to be tightened with a suitable tool.

⚠ Incomplete tightening of the screw threads may result in automatic release of the connection as well as degradation of the water tightness. Follow the "instructions for use" for installation of female connectors made by other manufacturers!

⚠ The cable connection to the female connector has to take place by qualified personnel! A short between individual conductors resp. to the connector housing, bad workmanship as well as improper shield connection may result in malfunction and breakdown of the valve.

## Operation Manual

### Sensor connection:

The sensor requires one connector assembly 4 + PE acc. to IEC61076-2-101 (M12).

☞ The connector assembly has to be ordered separately.

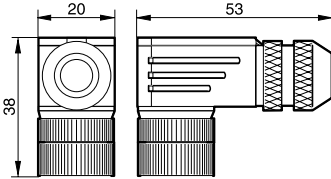

⚠ A female connector with metal housing is required! Plastic made models may create function problems due to insufficient EMC-characteristics.

The connection cable has to comply to the following specification:

Cable type: control cable, flexible, 4 conductors, overall braid shield  
 Cross section: min. 0.5 mm<sup>2</sup> (AWG 20)  
 Outer dimension: 6...8 mm  
 Cable length: max. 50 m

☞ For cable lengths > 50 m consult factory.

The connection cable will be coupled to the connector assembly via terminal screws.

The backshell nut of the cable gland has to be tightened with a suitable tool. The target value for the tightening torque is 10...20 Nm.

⚠ Incomplete tightening of the screw threads may result in automatic release of the connection as well as degradation of the water tightness. Follow the "instructions for use" for installation of female connectors made by other kind of brands!

⚠ The cable connection to the female connector has to take place by qualified personnel! A short between individual conductors resp. to the connector housing, bad workmanship as well as improper shield connection may result in malfunction and breakdown of the valve.

### Connection of the female connector assembly

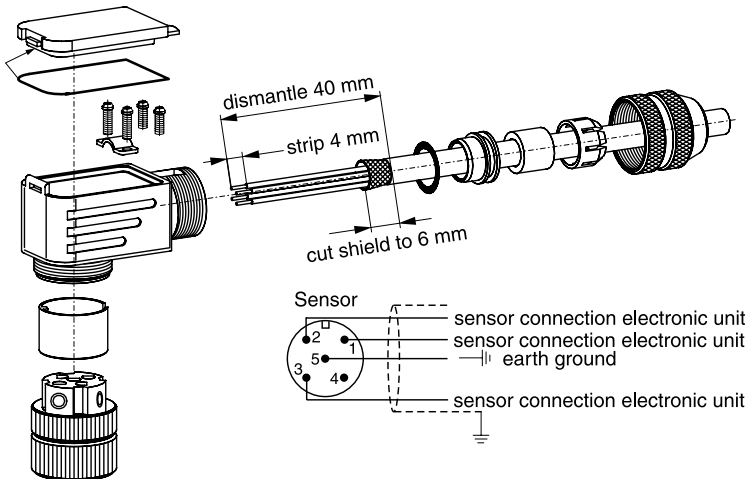



## Operation Manual

### 5. Operating Instructions

#### Electronic Control Unit

The valve has to be driven by a suitable electronic control unit.

 The compatible electronic may be selected from the catalog (chapter "Electronics"). When insecure, please consult the factory.

 Connection to an unsuitable electronic may cause irreparable damages to valve resp. electronic control!

#### Solenoid Selection

The selection of the suitable solenoid actuator is most important for the reliability of the valve. Miscellaneous valve series are available with multiple options concerning the nominal solenoid voltage. If the electronic provides a selection of solenoid parameters, the matching solenoid option has to be chosen.

 Instruction for using of valves with 24 V-solenoids:

Because of the increasing coil resistance up to 40% at heating, the electronic increases the solenoid voltage to keep the adjusted current constant. On solenoids with nominal voltages of 24 V this may result in an electronic supply voltage requirement of more than 24 V, to keep the nominal solenoid current constant. This denotes for example, that the supply voltage of the electronic unit for driving a solenoid with nominal data of 24 V / 0,8 A has to be increased up to 30 V to ensure the proper energizing of the solenoid. Therefore use preferably solenoids with lower voltage option!

 Do not exceed the nominal max. supply voltage value of the electronic unit! Non-observance of this rule may result in permanent damaging the electronic!

#### Air Bleeding of Hydraulic System

During initial startup, after an oil change as well as after the opening of lines or valves, the hydraulic system must be air bled. Air in the hydraulic system is very disadvantageous and therefore undesirable for the control system. The pipeline network is vented at its highest point. The fitting may be loosened a little so that the air can escape with only a small amount of oil loss. When the oil is no longer foaming, the fitting is re-tightened. Afterwards all functions are run through, one after the other, in no-load operation with low pressure and with full cylinder stroke. Afterwards the system should be vented once more.

 After air bleeding the oil level in the tank must be checked, and refilled as necessary!

#### Filter

The function and lifetime of the valve are strongly affected by the cleanliness of the fluid.

 Dirt is the greatest enemy of the hydraulic system!

There are three important sources of dirt to watch for:

- contamination arising during installation
- contamination arising during operation, friction wear
- impurities from the environment

Pressure filters are to be installed whenever proportional valves are used. Typically, filters with fineness of B-10 > 75 (10 µm) resp. B-3 > 75 (3 µm) are used.

 Pay attention to maintenance details!

#### Flushing

It is recommended to flush the long pipelines by short circuiting the pressure and return lines, especially for large, central pressure oil stations. This prevents the installation dirt from entering the valve.

# Operation Manual

## 6. Maintenance

 Service work may only be carried out by qualified personnel. Detailed knowledge of the machine functions concerning switching on and off as well as of the required safety-relevant technical tasks is required!

After a certain operating duration a change of the hydraulic fluid is required. The frequency of change depends from the following circumstances:

- kind resp. grade of the pressure fluid
- filtering
- operating temperature and environmental conditions

Periodical maintenance is essential for the longevity of the system and guarantees reliability and availability. The following properties of the system have to be checked in continuous short time intervals:

- oil level in the tank
- max. working temperature
- condition of the pressure fluid (visual inspection, colour and smell of hydraulic fluid)
- working pressure levels
- gas pre-load pressure on the pressure accumulator
- leakage on all system components
- condition of filter elements
- condition of hose lines
- cleanliness of components

malfunction at hydraulic load runtime									
- generally no function									
- high frequent oscillation									
- low frequent oscillation									
- one way operation only									
- speed variations at unchanging command									
- different speeds depending on travel direction (for directional control valves)									
- speed too low									
- drifting without command									
					possible reasons for malfunction			corrective actions	
X							hydraulic pump resp. motor defective	replace hydraulic pump resp. motor	
X		X	X	X	X	X	drive overloaded (for directional control valves)	reduce pressure resp. speed, increase valve size	
X		X	X	X	X	X	valve contaminated	clean pressure fluid, filter / flush valve	
				X		X	hydraulic fluid too viscous / too cold	change fluid grade, provide operational temperature	
X		X	X				too low oil level within tank	refill pressure fluid	
			X	X	X		filter contaminated	clean resp. replace filter	
X		X				X	electronic supply voltage too low	keep supply voltage range	
	X						electr. supply voltage carries too much ripple	reduce ripple	
X			X			X	electr. command signal too low	increase command signal	
	X						electr. command signal carries too much ripple	reduce ripple	
X							electr. enable signal too low / missing	keep enable signal range	
			X		X		center position adjustment incorrect	check center position adjustment	
X	X			X		X	contacts of connections contaminated	clean contacts / replace plugs	
X							feed cable interrupted	fix feed cable	
X	X	X	X	X		X	wiring sequence incorrect	correct wiring sequence	
	X					X	feed cable without shielding	change cable grade	

## Operation Manual

---

### 7. Trouble-Shooting

Basis of troubleshooting is always a systematic approach. At first the following questions have to be checked:

- are there practical experiences with similar failures?
- have system adjustments been changed?

Afterwards starting of troubleshooting by means of a priority list of the most likely reasons.



For suspect of a sluggish spool the valve may be flushed with clean pressure fluid.



Trouble-shooting in a hydraulic system requires in either case a systematic approach. The work may exclusively be performed by qualified personnel, as it requires detailed knowledge about function and construction of the system. Reversals or disassemblings may not be taken imprudently! Prior to the works it has to be clarified, if the system has been operated properly until the failure occurred.

### 8. Repair / Service

When you buy a Parker component, full technical support from Parker After Sales Service.

Our highly qualified team will be glad to assist you in all industrial and mobile applications.

We offer full service:

- general support for starting up Parker hydraulic controls
- maintenance of Parker controls
- repair of all Parker related hydraulic and electrical devices
- assistance in the supply of spare parts world-wide
- direct service for mobile applications at our Service Center in Kaarst, Germany
- direct replacement for parts subject to wear at our Service Center in Kaarst, Germany
- technical training in theory and practice

For further questions please contact us:

**Parker Hannifin**  
**Manufacturing Germany GmbH & Co. KG**  
 After Sales Service  
 Gutenbergstr. 38  
 D-41564 Kaarst  
 Phone: (+49)181-9944-430  
 Fax: (+49)181-9944-434199

