



Bulletin HY11-5715-681/UK

Operating instructions

Series

D31DW*EE, D31NW*EE, D*1VW*EE

Design series 92

II 2 G c T4 Gb

-20 °C < T_a < +60 °C



Pilot Operated Proportional DC Valve



Parker Hannifin

Manufacturing Germany GmbH & Co. KG

Hydraulic Controls Division Europe

Gutenbergstr. 38

41564 Kaarst, Germany

Tel.: (+49) 181 99 44 43 0

E-mail: infohcd@parker.com

Copyright © 2013, Parker Hannifin Corp.

Note

This document and other information from Parker-Hannifin Corporation, its subsidiaries and authorized distributors provide product or system options for further investigation by users having technical expertise.

The user, through its own analysis and testing, is solely responsible for making the final selection of the system and components and assuring that all performance, endurance, maintenance, safety and warning requirements of the application are met. The user must analyze all aspects of the application, follow applicable industry standards, and follow the information concerning the product in the current product catalog and in any other materials provided from Parker or its subsidiaries or authorized distributors.

To the extent that Parker or its subsidiaries or authorized distributors provide component or system options based upon data or specifications provided by the user, the user is responsible for determining that such data and specifications are suitable and sufficient for all applications and reasonably foreseeable uses of the components or systems.

Contents	Page
0. EC declaration of conformity	4
1. Introduction	5
Ordering code	6
Technical data	8
Characteristic curves	9
Pilot oil	11
Dimensions	12
Name plate	15
2. Safety instructions	15
Symbols	15
Marking, Name plates	15
Work on the valve	16
3. Important information	16
Correct use	16
Common instructions	16
Liability	16
Storage	16
4. Installation	17
Scope of delivery	17
Installation	17
Electrical connection	17
Operation limits	17
Pressure fluids	17
5. Operating instructions	20
Air bleeding of hydraulic system	20
Filter	20
Flushing	20
6. Maintenance	20
7. Troubleshooting	21
A1 Extract from standards/directives	22
A2 User guide – Solenoid	23
A3 Type-examination certificate – Solenoid	27
A4 Declaration of conformity - Solenoid	32
A5 Mounting instruction cable gland	33

0. EC declaration of conformity

EG KONFORMITÄTSERKLÄRUNG

DECLARATION OF CONFORMITY

DECLARATION DE CONFORMITÉ

im Sinne der EG-Richtlinie 94/9/EG vom 23.03.1994 und mit den zu ihrer Umsetzung erlassenen Rechtsvorschriften Pursuant to European Directive 94/9/EC dated 23 March 1994 and statutory provisions relating to its implementation Dans le sens de la directive 94/9/CE datée du 23 3 1994 et des prescriptions légales promulguées quant à son application.

Wir
We
Nous

Anschrift
address
adresse

erklären, dass die in der Betriebsanleitung beschriebenen, explosionsgeschützt ausgeführten hereby declare that, as described in the operation instructions, the explosion-proof déclarons que, comme décrit dans ce mode d'emploi, les soupapes antidéflagrantes type

der Serie
series
de la série

Geräte im Sinne des Artikels 1 (3) der RL 94/9/EG sind und die grundlegenden Sicherheits- und Gesundheitsanforderungen gemäß Anhang II der Richtlinie 94/9/EG erfüllen.

are equipment as defined in Article 1 (3) of Directive 94/9/EC and comply with the essential health and safety requirements set out in Annex II of Directive 94/9/EG.

correspondent aux appareils dans le sens de l'article 1 (3) de la directive RL 94/9/CE et qu'ils remplissent les exigences fondamentales relatives à la sécurité et la santé selon l'annexe II de la directive 94/9/CE.

Die grundlegenden Sicherheits- und Gesundheitsanforderungen werden erfüllt in Übereinstimmung mit folgenden Normen: The essential health and safety requirements are met in accordance with the following standards:

Les exigences relatives à la sécurité ainsi qu'à la santé sont remplies en conformité avec les normes suivantes:

EN 1127-1
EN 13463-1
EN 13463-5
EN 982

Die Kennzeichnung der Geräte enthalten folgende Angaben:

The marking of the equipment contains the following information:

Les marquages des appareils contiennent les indications suivantes :



Der korrekte Gebrauch der Geräte bei Installation und Betrieb wird vorausgesetzt. Details zum korrekten Gebrauch (einschließlich Explosionsschutz) sind in der Betriebsanleitung zu finden.

It is assumed that the equipment will only be installed and operated in accordance with correct use. Details of correct use can be found in the operating instructions incl. explosion protection.

Il est obligatoire d'installer et d'utiliser les appareils de la manière correcte. Le mode d'emploi contient des détails pour l'utilisation correcte, comprenant la protection antidéflagrante.

Kaarst, 03.12.2012

A handwritten signature in black ink, appearing to read 'i.v. H. Kolvenbach', written over a horizontal line.

Technischer Leiter
Technical manager
Directeur technique
Hansgeorg Kolvenbach

A handwritten signature in black ink, appearing to read 'i.v. W. Bausch', written over a horizontal line.

QM-Beauftragter
QM officer
Responsable qualité
Wolfgang Bausch

Operating Instructions

1. Introduction

The D*1*W*EE with explosion proof solenoids are based on the standard D*1*W series. The specific solenoid design allows the usage in hazardous environments.

The explosion proof class is

CE  II 2 G
Ex mbe II T4 Gb

for use in zone 1 (conform to ATEX).

All explosion proof solenoids are DC design. The valves for AC operate with integrated rectifier.

The pilot operated valves are available in 4 sizes:

D31DW NG10 (standard)

D31NW NG10 (high flow)

D41VW NG16

D91VW NG25 (for port diameter up to 32 mm)

D111VW NG32

All valves are piloted by a D1VW valve. The minimum pilot pressure must be ensured for all operating conditions of the directional valve.

Additionally spools with a P to T connection in the de-energized position need an external pressure supply (external inlet) or an integral check valve.

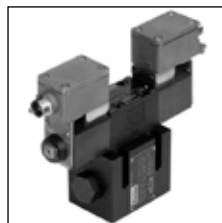

D31DW

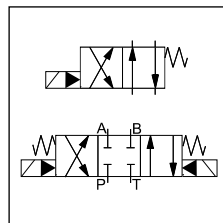

D31NW

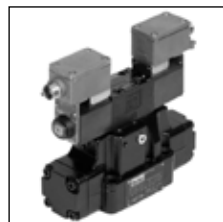

D41VW

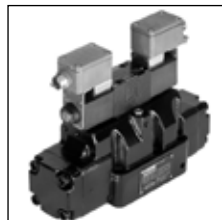

D91VW



D111VW

D91VW

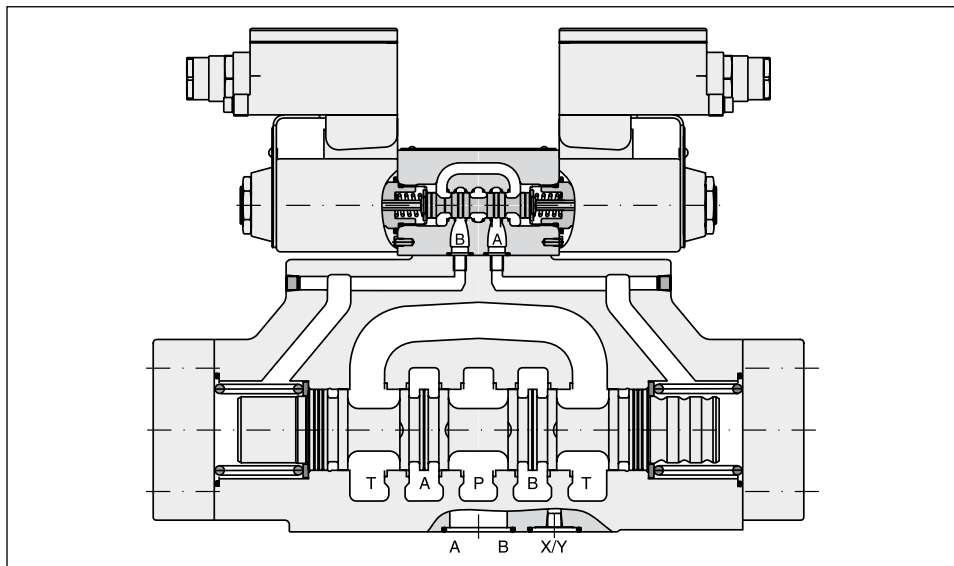

Operating Instructions

Pilot Operated Proportional DC Valve Series D*W*EE Explosion Proof

Ordering code

Code	Bore	Size	Feature
D31DW	Ø11mm	NG10	
D31NW	Ø11mm	NG10	High flow
D41VW	Ø20mm	NG16	
D91VW	Ø32mm	NG25	
D111VW	Ø50mm	NG32	



Series



Spool type



Spool position

3 position spool	
Code	Spool type
	a 0 b
001 ²⁾	
002 ²⁾	
003 ³⁾	
004 ³⁾	
005 ³⁾	
006 ³⁾	
009 ¹⁾²⁾	
011 ³⁾	
015 ³⁾	
016 ³⁾	
021 ³⁾	
022 ³⁾	

2 position spool	
Code	Spool type
	a b
020 ²⁾	
030 ²⁾	

3 position spool		
Code	Spool position	
C ²⁾		3 positions. Spring offset in position "0". Operated in position "a" or "b".
	Standard	Spool type 009
E ²⁾	 Operated in position "a".	 Operated in position "b". 2 positions. Spring offset in position "0".
F ²⁾	 Spring offset in position "b".	 Spring offset in position "a". 2 positions. Operated in position "0".
K ²⁾	 Operated in position "b".	 Operated in position "a". 2 positions. Spring offset in position "0".
M ²⁾	 Spring offset in position "a".	 Spring offset in position "b". 2 positions. Operated in position "0".
R ³⁾	 No centre in offset position.	 No centre in offset position. 2 positions, detent. Operated in position "0" or "b".
S ³⁾	 No centre in offset position.	 No centre in offset position. 2 positions, detent. Operated in position "0" or "a". No center in offset position.

2 position spools		
Code	Spool position	
B ²⁾		Spring offset in position "b". Operated in position "a".
D ³⁾		Detent, operated in position "a" or "b". No center or offset position.
H ²⁾		Spring offset in position "a". Operated in position "b".

Operating Instructions

Pilot Operated Proportional DC Valve Series D*W*EE Explosion Proof

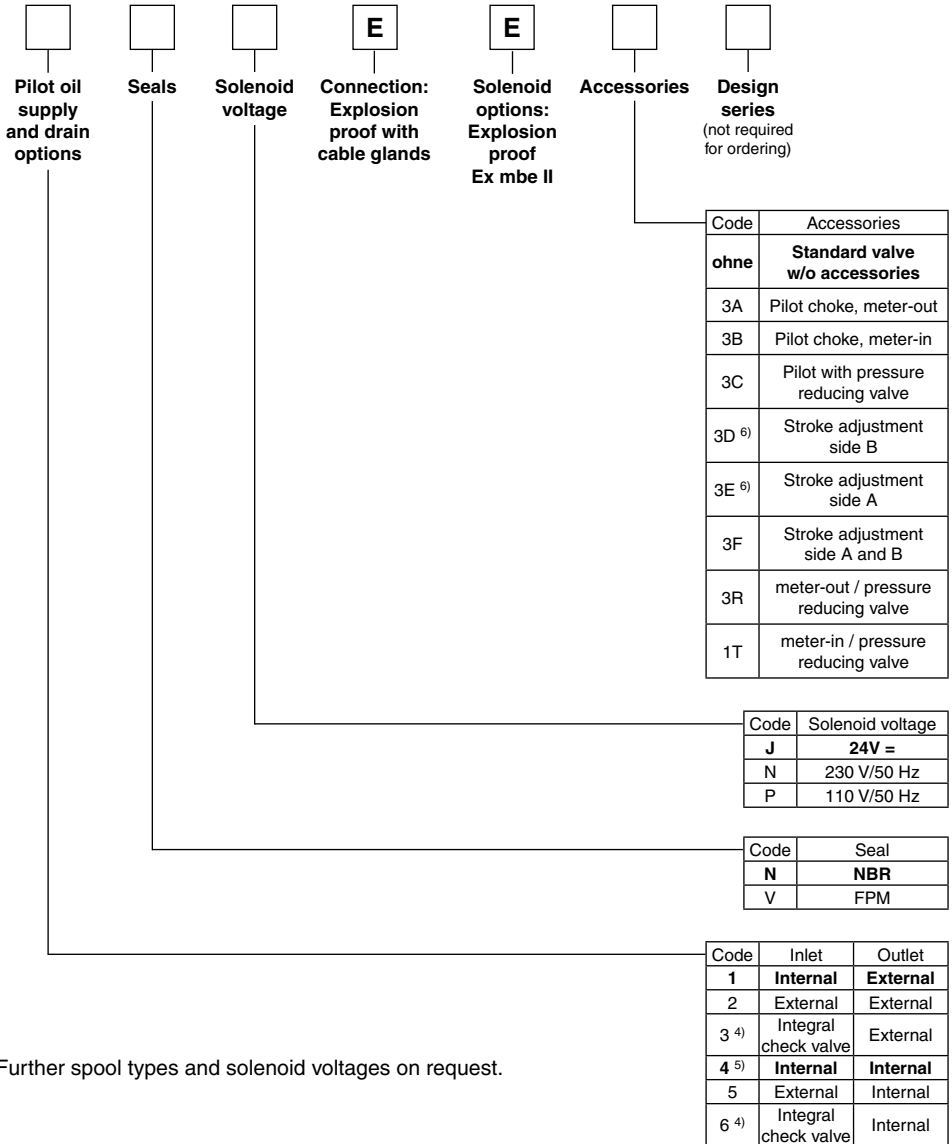

1) Consider specific spool position.
 2) All sizes (D31, D41, D 91, D111) available
 3) Only D31, D41, D91 available.
 4) Not for D31DW and D111VW available.
 5) Not for spools 002, 009 available.
 6) Only D31, D41, D91 available.

Technical data

General					
Design	Directional spool valve				
Actuation	Solenoid				
Series	D31DW	D31NW	D41VW	D91VW	D111VW
Size	NG10	NG10	NG16	NG25	NG32
Weight (1/2 solenoids)	[kg] 6.0 / 6.6	7.6 / 8.1	9.7 / 10.3	17.9 / 18.6	67.4 / 68.0
Mounting interface	DIN 24340 A10 ISO 4401 NFPA D05	DIN 24340 A10 ISO 4401 NFPA D05	DIN 24340 A16 ISO 4401 NFPA D07	DIN 24340 A25 ISO 4401 NFPA D08	DIN 24340 A32 ISO 4401 NFPA D10
CETOP RP 121-H					
Mounting position	unrestricted, preferably horizontal				
Ambient temperature	[°C] -20...+60				
MTTF _D value	[years] 75				
Hydraulic					
Max. operating pressure	[bar] P, A, B: 350; T: 140				
Fluid	Hydraulic oil in accordance with DIN 51524 / 51525				
Fluid temperature	[°C] -25 ... +60				
Viscosity	permitted [cSt] / [mm ² /s] 2.8...400				
	recommended [cSt] / [mm ² /s] 30...80				
Filtration	ISO 4406 (1999); 18/16/13				
Flow max.	[l/min] 150	170	300	700	2000
Leakage at 350 bar (per flow path)	[ml/min] up to 100*	up to 150*	up to 200*	up to 800*	up to 5000*
*depending on spool					
Opening pressure integral check valve	[bar] n.a.	see p/Q diagram	see p/Q diagram	see p/Q diagram	n.a.
Minimum pilot supply pressure	[bar] 5	7	5		
Static / Dynamic					
Step response at 95 %	[ms] Energized / De-energized				
DC solenoids Pilot pressure	50 bar	60 / 40 (50/60)	95 / 65	150 / 170	470 / 390
	100 bar	55 / 40 (50/60)	75 / 65	110 / 170	320 / 390
	250 bar	55 / 40 (50/50)	60 / 65	90 / 170	210 / 390
	350 bar	55 / 40 (50/50)	60 / 65	85 / 170	200 / 390
AC solenoids Pilot pressure	50 bar	40 / 30 (30/50)	75 / 55	130 / 155	450 / 375
	100 bar	35 / 30 (30/50)	65 / 55	90 / 155	300 / 375
	250 bar	35 / 30 (30/50)	40 / 55	70 / 155	190 / 375
	350 bar	35 / 30 (30/50)	40 / 55	65 / 155	180 / 375
Electrical characteristics					
Duty ratio	100 % ED; CAUTION: coil temperature up to 135 °C possible				
Protection class	CE II 2 G, Ex mbe II T4 Gb, IP66 (plugged and mounted correctly)				
Supply voltage / ripple	Code	J	N	P	
	[V] 24 V =		230/50 Hz	110/50 Hz	
	Tolerance supply voltage	[%] ±10	±10	±10	
	Current consumption	[A] 1.0	0.12	0.25	
	Power consumption	[W] 24	24	24	
Solenoid connection	Box with M20x1.5 entry for cable glands. Solenoid identification as per ISO 9461.				
Wiring min.	[mm ²] 3 x 1.5 recommended				
Wiring length max.	[m] 50 recommended				

With electrical connections the protective conductor (PE \downarrow) must be connected according to the relevant regulations.

Operating Instructions

Pilot Operated Proportional DC Valve Series D*W*EE Explosion Proof

Flow curves

The flow curve diagram shows the flow versus pressure drop curves for all spool types. The relevant

curve number for each spool type, operating position and flow direction is given in the table below.

D31DW and D41VW

Spool Code	Curve number									
	P-A		P-B		P-T		A-T		B-T	
	D3	D4	D3	D4	D3	D4	D3	D4	D3	D4
001	3	1	3	1	-	-	1	4	1	5
002	3	1	3	2	4	6	1	4	1	6
003	3	1	4	2	-	-	1	5	1	6
004	3	1	3	1	-	-	1	5	1	5
005	3	2	4	2	-	-	1	3	1	5
006	3	1	3	2	-	-	1	3	1	6
007	4	1	3	1	-	6	1	4	1	5
009	3	2	3	9	8	8	1	7	1	10
011	3	1	3	1	-	-	1	4	1	5
014	3	1	4	1	-	6	1	4	1	5
015	4	1	3	2	-	-	1	4	1	6
016	4	2	3	2	-	-	1	3	1	5
020	3	3	4	5	-	-	1	3	1	5
021	4	2	3	8	-	-	1	2	-	-
022	3	8	4	2	-	-	-	-	1	3
026	3	3	3	5	-	-	-	-	-	-
030	3	2	1	3	-	-	1	6	1	7
054	-	2	-	3	-	-	-	6	-	7

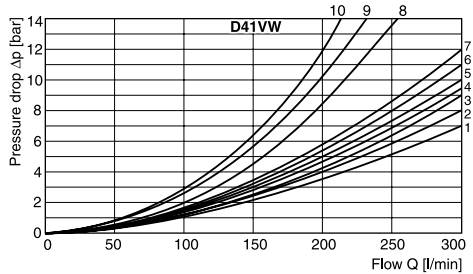
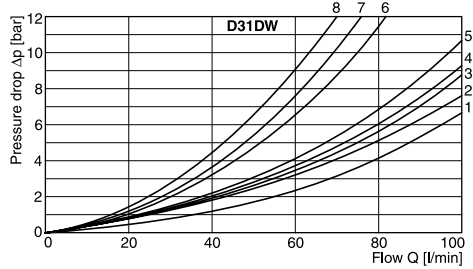

D31NW

Spool Code	Curve number				
	P-A	P-B	P-T	A-T	B-T
001	3	3	-	2	5
002	3	3	7	4	3
003	2	3	-	4	4
004	2	3	-	4	4
005	2	4	-	1	4
006	8	9	-	7	9
009	4	6	6	4	10
011	3	3	-	2	4
015	2	2	-	1	4
016	4	3	-	2	4
020	6	4	-	3	6
021	-	7	-	8	-
022	4	-	-	9	-
030	5	3	-	2	5

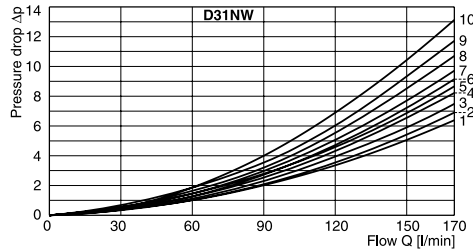

All characteristic curves measured with HLP46 at 50 °C.

Operating Instructions

Pilot Operated Proportional DC Valve Series D*W*EE Explosion Proof

Flow curves / Integral check valve D91VW and D111VW

Spool Code	Curve number									
	P-A		P-B		P-T		A-T		B-T	
	D9	D11	D9	D11	D9	D11	D9	D11	D9	D11
001	3	5	2	5	-	-	3	4	5	1
002	2	5	1	5	1	5	3	4	5	1
003	4	-	2	-	-	-	3	-	6	-
004	4	-	3	-	-	-	3	-	5	-
005	1	-	2	-	-	-	4	-	5	-
006	2	-	2	-	-	-	4	-	6	-
007	3	-	1	-	7	-	3	-	5	-
009	4	3	8	3	9	2	4	3	10	1
011	3	-	2	-	-	-	3	-	5	-
014	1	-	2	-	8	-	3	-	5	-
015	3	-	3	-	-	-	4	-	5	-
016	3	-	3	-	-	-	4	-	5	-
020	6	5	5	5	-	-	6	3	8	1
021	5	-	10	-	-	-	3	-	-	-
022	10	-	5	-	-	-	-	-	5	-
026	6	-	5	-	-	-	-	-	-	-
030	3	5	2	5	-	-	3	4	5	1
054	4	5	3	5	-	-	3	4	5	1

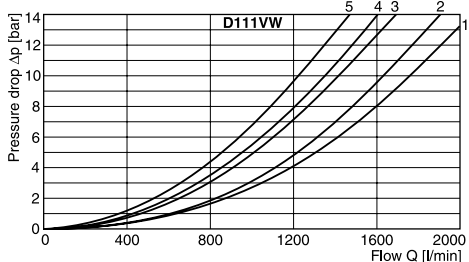
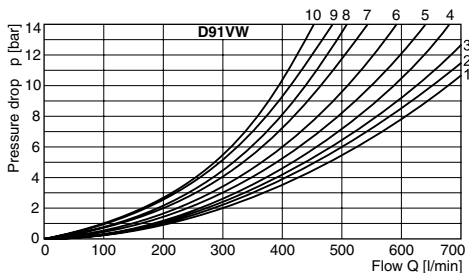

Integral check valve in the P port

Mounting an integral check valve in the P port is necessary to build up pilot pressure for valves with P to T connection and internal pilot oil supply. The pressure difference at the integral check valve (see performance curves) is to be added to all flow curves of the P-port of the main valve. Directional valves with an integral check valve are available for the series D31NW and D41VW.

Flow curve D41VW

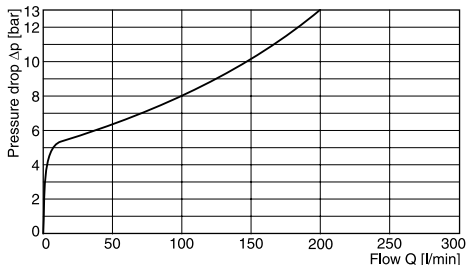

Flow curve D31NW

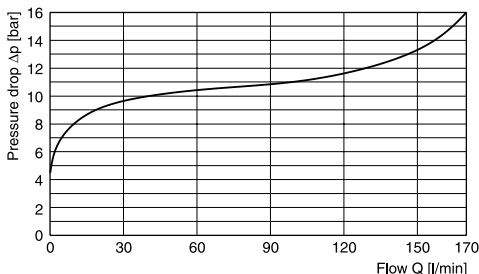

Flow curve D91VW

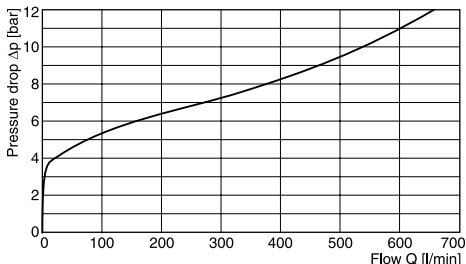

Operating Instructions

Pilot oil inlet (supply) and outlet (drain)

D31DW

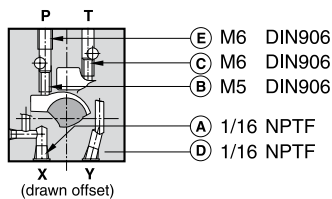

○ open, ● closed

Pilot oil		A	B	C	D	E
Inlet	Outlet					
internal	external	●	○	○	○	Orifice Ø1.2
external	external	○	●	●	○	Orifice Ø1.2
internal	internal	●	○	○	●	Orifice Ø1.2
external	internal	○	●	○	●	Orifice Ø1.2

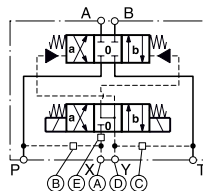

D31NW

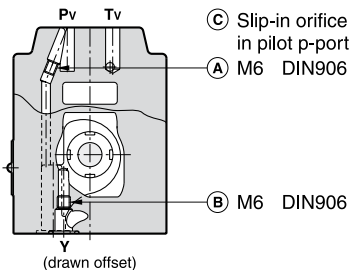

○ open, ● closed

Pilot oil		A	B	C
Inlet	Outlet			
internal	external	○	●	Orifice Ø1.0
external	external	●	●	Orifice Ø1.0
internal	internal	○	○	Orifice Ø1.0
external	internal	●	○	Orifice Ø1.0

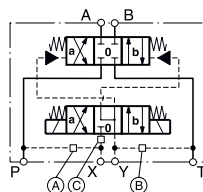

D41VW

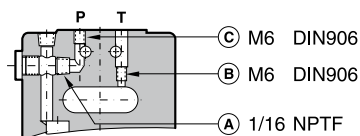

○ open, ● closed

Pilot oil		A	B	C
Inlet	Outlet			
internal	external	○	●	Orifice Ø1.5
external	external	●	●	Orifice Ø1.5
internal	internal	○	○	Orifice Ø1.5
external	internal	●	○	Orifice Ø1.5

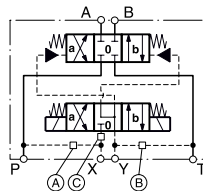

D91VW

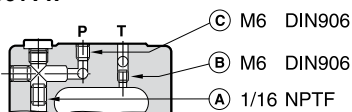

○ open, ● closed

Pilot oil		A	B	C
Inlet	Outlet			
internal	external	○	●	Orifice Ø1.5
external	external	●	●	Orifice Ø1.5
internal	internal	○	○	Orifice Ø1.5
external	internal	●	○	Orifice Ø1.5

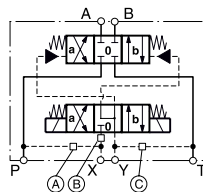

D111VW

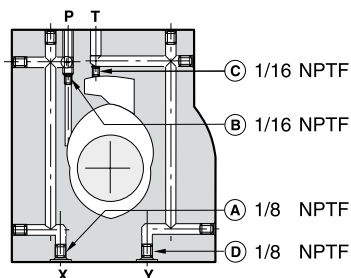

○ open, ● closed

Pilot oil		A	B	C	D
Inlet	Outlet				
internal	external	○	Orifice Ø1.5	●	○
external	external	Orifice Ø1.5	●	●	○
internal	internal	○	Orifice Ø1.5	○	○
external	internal	Orifice Ø1.5	●	○	○

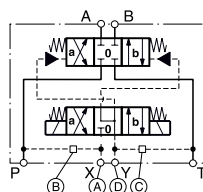





All orifice sizes for standard valves

Operating Instructions

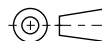
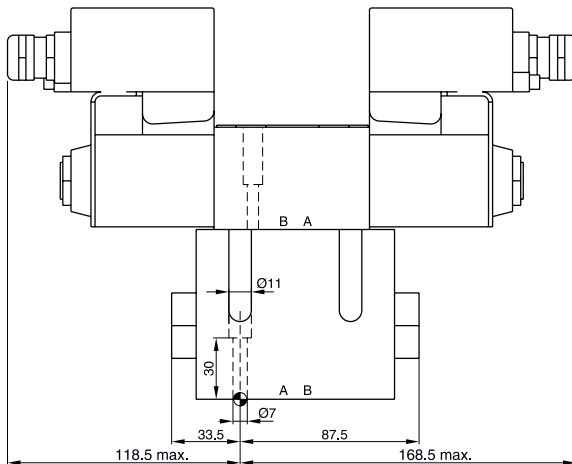
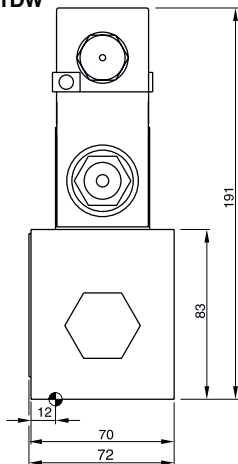
Dimensions



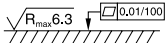

D31DW

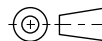
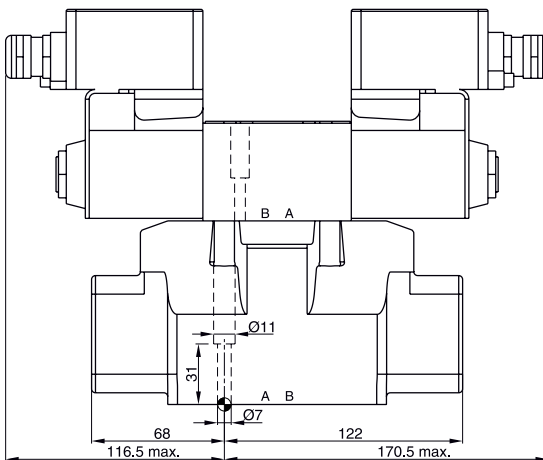
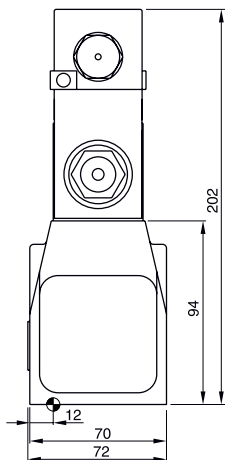

Surface finish	 Kit	 Kit	 Kit	 Kit
	BK385	4x M6x40 ISO 4762-12.9	13.2 Nm ±15 %	NBR: SK-D31DW-N-91 FPM: SK-D31DW-V-91

D31NW

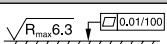

Surface finish	 Kit	 Kit	 Kit	 Kit
	BK385	4x M6x40 ISO 4762-12.9	13.2 Nm ±15 %	NBR: SK-4D02V-B1 FPM: SK-4D02V-B5

Operating Instructions

Pilot Operated Proportional DC Valve Series D*W*EE Explosion Proof

D41VW

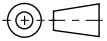
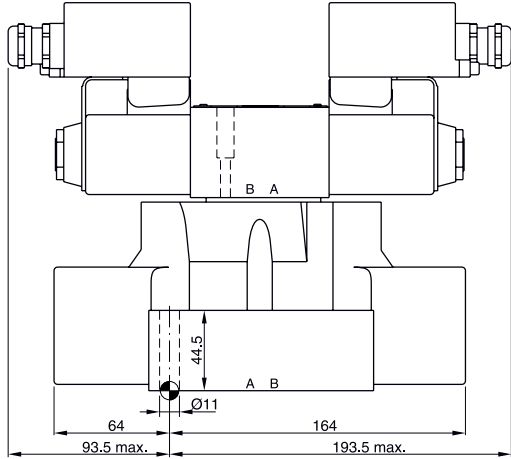
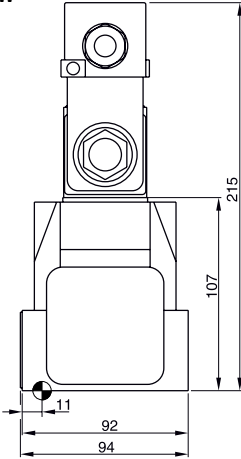

Surface finish	Kit			Kit
$\sqrt{R_{max}6.3}$ $\square[0.01/100]$	BK320	4x M10x60 2x M6x55 ISO 4762-12.9	63 Nm $\pm 15\%$ 13.2 Nm $\pm 15\%$	NBR: SK-D41VW-N-91 FPM: SK-D41VW-V-91

D91VW

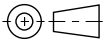
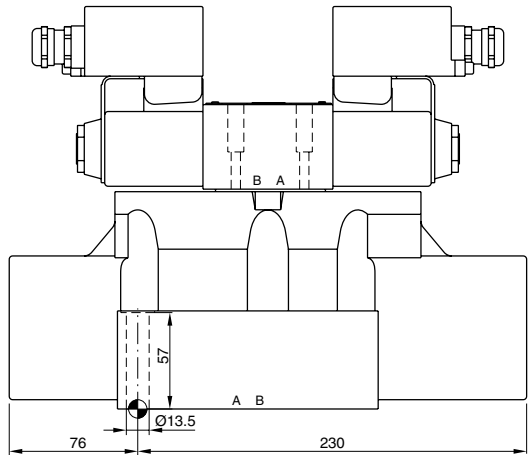
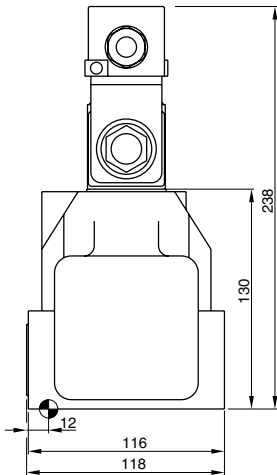

Surface finish	Kit			Kit
$\sqrt{R_{max}6.3}$ $\square[0.01/100]$	BK360	6x M12x75 ISO 4762-12.9	108 Nm $\pm 15\%$	NBR: SK-D81VW-N-91 / SK-D91VW-N-91 FPM: SK-D81VW-V-91 / SK-D91VW-V-91





D_W_EE_92 5715-681 UK.indd CM 07.05.13

Operating Instructions

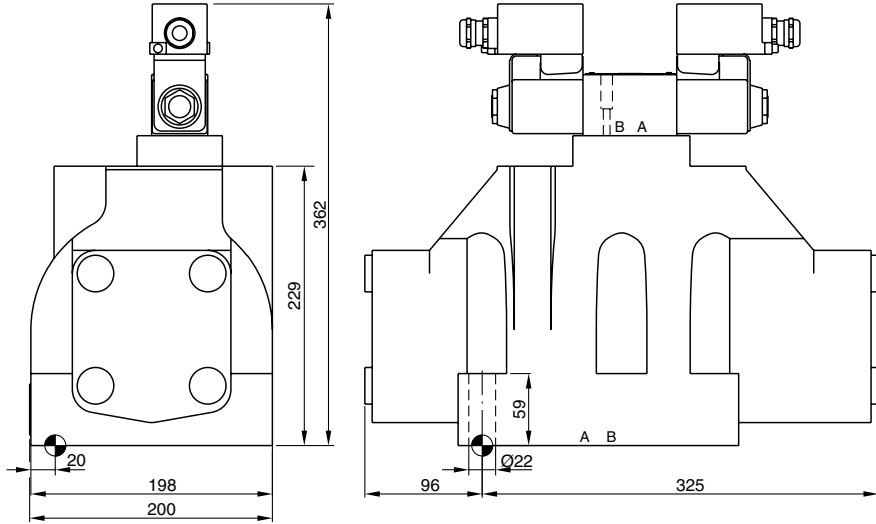
Pilot Operated Proportional DC Valve Series D*W*EE Explosion Proof

D111VW

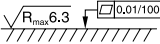

Surface finish	 Kit	 		 Kit
	BK386	6x M20x90 ISO 4762-12.9	517 Nm ±15 %	NBR: SK-D111VW-N-91 FPM: SK-D111VW-V-91

Operating Instructions

Name plate



- Manufacturer's logo and address
- CE mark, Ex protection symbol and explosion protection class of the complete valve to European Directive 94/9/EC
- Entire name of the complete valve
- Hydraulic data
- Code for year and month of manufacture
- Hydraulic symbol

2. Safety instructions

Read the operating instructions thoroughly before installation, commissioning, maintenance, repair and storage, and observe them. Failure to observe the operating instructions may result in damage to the valve or the parts of the system connected to it. In particular, in the case of explosive atmospheres, any failure to observe the operating instructions may result in an explosion.

The system operator must make these operating instructions visible and easily accessible to operating and maintenance personnel.

Compliance with applicable standards/legal requirements must be enforced. This particularly applies to plant safety and environmental protection. A list of such standards, etc. appears in the annex by way of example.

Before starting commissioning, installation, maintenance and repair work, the hydraulic system must be depressurised and power must be disconnected from the electrical installation.

In addition, the electrical installation must be secured so that power cannot be restored unexpectedly.

The valve may become hot during operation. To avoid risk of burns, do not touch the valve surface. The system operator must monitor the temperature and cool the oil if necessary in order to the

keep within the maximum temperatures set out in these operating instructions (see technical data). In this connection, observe the relevant directions in the operating instructions of the supplier (solenoid system).

Any leaks occurring at the valve must be rectified immediately.

Symbols

These instructions use symbols that must be noted according to their importance:



Notes relating to the warranty



Notes relating to potential damage to the valve or connected system components



Notes relating to potential hazards



Useful additional information

Marking, Name plates

Information attached directly to the valve such as circuit plans and Name plates must be observed and kept in a legible state.

Operating Instructions

Work on the valve

Work relating to the installation, commissioning, maintenance and repair of the valve may only be carried out by qualified persons. Qualified persons are defined as persons who, on the basis of education, experience and instruction, have sufficient knowledge of applicable requirements and accepted rules of the technology.

Throughout any installation, commissioning, maintenance and repair work, it is the responsibility of the operator to ensure that there is no risk of explosion.

Before starting such work, the operator has to ensure that tools and equipment are only used if they do not damage the valve and they do not leave behind residues that are inflammable.

In addition, clean the valve before starting such work, in particular removing dust, liquids and other deposits. Cleaning should be done using a lint-free cloth.

Tools may not be used if they might cause a static charge on use.

3. Important information

Correct use

 These operating instructions apply to proportional DC valves of series D1VW*EE, which are intended solely for use in mineral oil based hydraulic systems (DIN 51524).

Compliance with the operating instructions must be ensured.

It is the responsibility of the operator to ensure that the information in the technical data is followed.

Any different or modified use is not classed as correct use.

The manufacturer's warranty will not cover any resulting damage.

Common instructions

We reserve the right to make technical changes as a result of further development of the product described in these operating instructions. Figures and drawings in these instructions are simplified depictions. As a result of further development, improvements and changes to the product, it is possible that the figures are not fully consistent with the described valve.

The technical details and dimensions are non-binding. They may not form the basis of any claims. Copyright reserved.

Liability

The manufacturer cannot accept liability for loss or damage resulting from the following faults:

- incorrect installation
- unqualified operation
- inadequate maintenance
- use beyond specification



Do not dismantle the valve. If you suspect a defect, return the valve to the factory.

Storage

If the valve needs to be temporarily stored, it must be protected from dirt, the weather, and mechanical damage. Each valve is tested with hydraulic oil in the factory, so that the internal components are protected from corrosion. However, this protection can only be guaranteed under the following conditions:

Storage time	Storage requirements
12 months	constant air humidity < 60 % constant temperature < 25 °C
6 months	varying air humidity, varying temperature < 35 °C



Storage outside or in maritime or tropical climates leads to corrosion and may make the valve unusable.

Operating Instructions

4. Installation

Scope of delivery

As soon as you receive the valve you should check if the package has the specified contents. In particular, check whether the type of protection indicated on the valve is as described in these operating instructions.

The scope of delivery includes:

- Valve
- Operating instructions (including operating instructions of the valve as well as of the solenoid and the declarations of conformity of the manufactures)

 As soon as you receive the shipment, please check for any obvious signs of damage caused by careless transport. Document the transport damage and immediately notify the carrier, the insurance company and the supplier.

Installation

- Compare the valve type as stated on the Name plate with the parts list/circuit diagram.
- The valve can be installed in any position, either fixed or movable.

 Check the fixing surface and the cavity for the valve. Permitted values: unevenness 0.01 mm/100 mm, roughness $R_{max} = 6.3 \mu\text{m}$. Keep the valve mounting surface and the area clean.

- Before installation, remove the protective cover from the valve ports.
- Check that the valve ports and the O-rings are in the correct position.
- Use fastening screws as indicated in the catalogue, property class 12.9 to ISO 4762.

 Parker can supply the correct screw sets, see the catalogue for order numbers.

- Tighten the screws diagonally, torque as specified in the catalogue.
- Any deficiencies of the valve mounting surface may result in operating disruptions. Faulty fixing and incorrect screw tightening torques may lead to the sudden escape of hydraulic fluid at the ports.
- The valve must be connected to the equipotential bonding system of the hydraulic system.

Electrical connection

Observe operating instructions D14-2115D and K14-2069D in the annex.

Operation limits

The valve may only be deployed with the specified limits of use. The relevant details can be found in the catalogue sheet under "Technical data" and "Characteristic curves".



Observe the ambient conditions. Unauthorised temperatures, shocks, the effects of aggressive chemicals, radiation, unauthorised electromagnetic emissions may result in disruptions and failures. Observe the limits of operation set out in "Technical data".



Excessive temperatures may cause the solenoid to overheat, creating the risk of explosion. To permit adequate heat dissipation, the solenoid coil should not be painted.

Pressure fluids

For details of valve operation using different pressure fluids, see HY11-AL103-M1.



The details given here are provided for information only and do not replace in-house testing under the applicable operating conditions. In particular, the details cannot be interpreted as a guarantee of media compatibility.



For detailed information about pressure fluids, see VDMA sheet 24317 and DIN 51524, 51502. Special sealing materials are supplied depending on the fluid used. Please ask the factory if you are unsure.

The pressure fluid must have an ignition temperature of at least 50 K above the maximum surface temperature of the valve (see EN 13463-5 and IEC 60079-4).

Operating Instructions

Pilot Operated Proportional DC Valve Series D*W*EE Explosion Proof

Size 10, mounting pattern ISO 4401-05-05-0-05

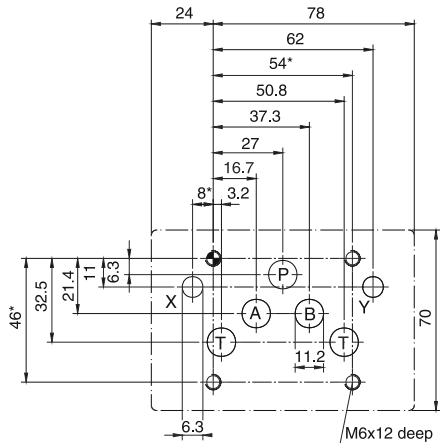

Deviating from ISO 4401
these diameters are possible:
X, Y = \varnothing 8 max.

Size 16, mounting pattern ISO 4401-07-07-0-05

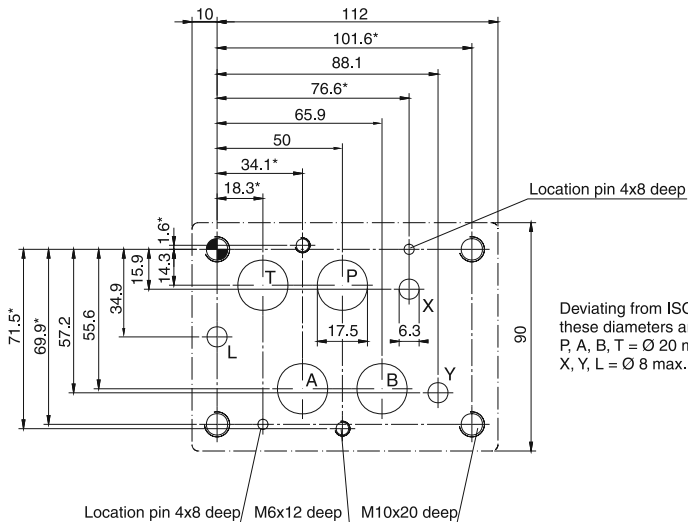

Deviating from ISO 4401
these diameters are possible:
P, A, B, T = \varnothing 20 max.
X, Y, L = \varnothing 8 max.

With * marked dimensions ± 0.1 mm.
All other dimensions ± 0.2 mm.

D_W_EE_92 5715-681 UK.indd CM 07.05.13

Operating Instructions

Pilot Operated Proportional DC Valve Series D*W*EE Explosion Proof

Size 25, mounting pattern ISO 4401-08-08-0-05

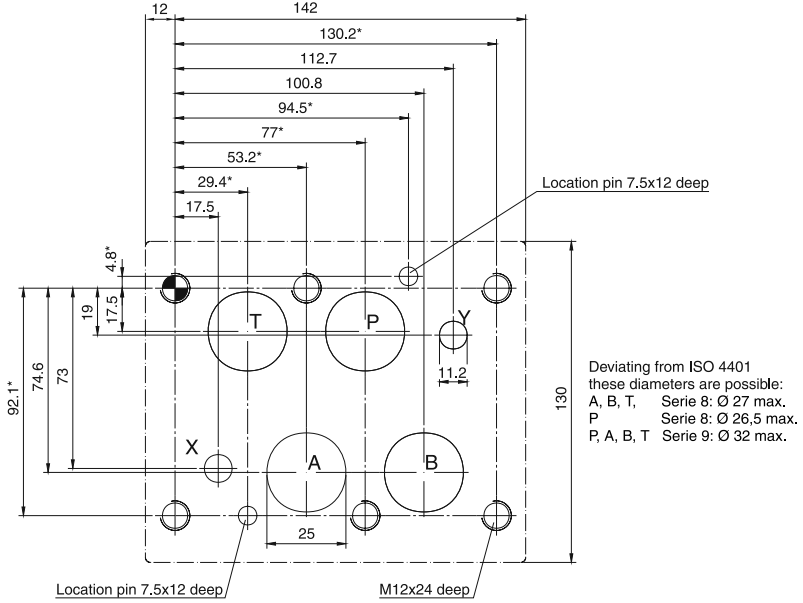

Size 32, mounting pattern ISO 4401-10-09-0-05

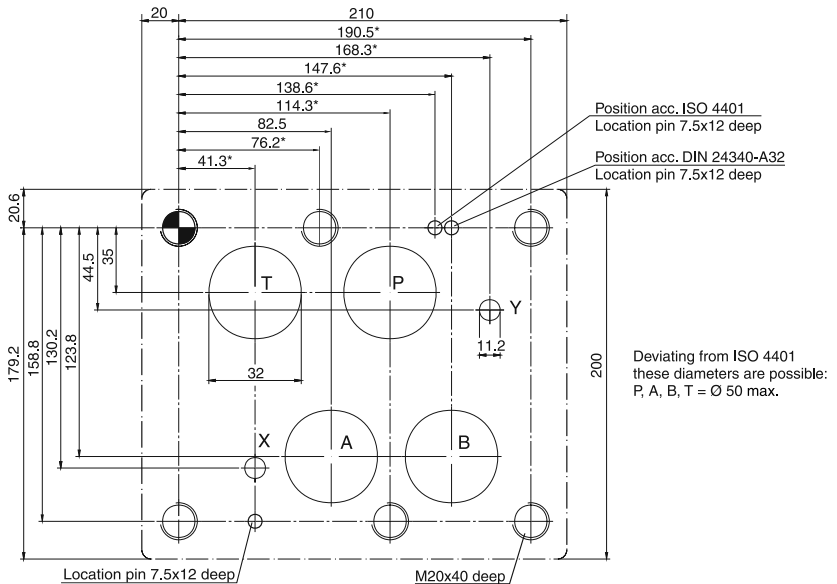

With * marked dimensions ± 0.1 mm.
 All other dimensions ± 0.2 mm.

D_W_EE_92 5715-681 UK.indd CM 07.05.13

Operating Instructions

5. Operating instructions

Air bleeding of hydraulic system

The hydraulic system must be vented on initial commissioning, after an oil change or after lines or valves are opened. Air in the hydraulic system is highly detrimental to the behaviour of the control system and is therefore undesirable. Air bleeding takes place at the highest point of the pipe network.

Loosen the vent screw slightly, allowing air to escape until oil flows. When the escaping oil no longer contains air bubbles, tighten the screw again. Then work through all functions in succession, in no-load operation with the lowest possible pressure, and with the full consumer range. Finally, vent the system again.



After air bleeding, check the oil level in the tank and top up with oil if necessary.

Filter

The operation and service life of the valve are highly dependent on the cleanliness of the pressure fluid.



Dirt is the biggest enemy of a hydraulic system.

Be aware of three important sources of contamination:

- impurities entering during installation
- impurities occurring during operation, abrasion
- dirt entering from the surroundings

Pressure filters must always be used with proportional valves. For actual values, see the data sheet.



Follow the maintenance instructions.

Flushing



With large central pressurised oil stations in particular, you are recommended to flush the long pipes by short circuiting the pressure and return lines.

This prevents the dirt occurring during installation from being carried to the valve.

6. Maintenance



Maintenance procedures may only be carried out by specialist personnel. A detailed knowledge is required of how the machine is switched on and off and also of the necessary safety measures.

Regular maintenance is essential in prolonging the service life of the systems, and safeguards plant safety and operational availability. The following items must be checked at regular and short intervals:

- Oil level in tank
- Max. medium temperature
- Max. surface temperature
- Condition of the pressure fluid (sight check, colour and smell of hydraulic fluid)
- Operating pressures
- Preload pressure of pressure vessel (if present)
- No leaks at any system components
- Condition of the filter elements
- Condition of the hose lines
- Cleanliness of components

After a certain period of service, the hydraulic fluid must be replaced. The frequency of the change depends on the following circumstances:

- Type and grade of pressure fluid (ageing)
- Filtration
- Operating temperature and ambient conditions

A1.

Standards, directives and provisions relating to the operation of systems in potentially explosive areas (extract)

Directive 1999-92-EC	Minimum requirements for improving the safety and health protection of workers potentially at risk from explosive atmospheres (15th individual Directive within the meaning of Article 16(1) of Directive 89/391/EEC)
EN 60529	Degrees of protection provided by enclosures (IP code) IEC 60529:1989 + A1:1999); German version EN 60529:1991 + A1:2000
EN 982	Safety of machinery - Safety requirements for fluid power systems and their components – Hydraulics
BGR 132	Elimination of fire hazards caused by static charges (see also CENELEC Report-No. R044-001)
EN 60079-14	Electrical apparatus for explosive gas atmospheres - Part 14: Electrical installations in hazardous areas (other than mines) (IEC 60079-14:2002)
EN 60079-17	Explosive atmospheres - Part 17: Electrical installations inspection and maintenance (IEC 60079-17:2007)
EN ISO 12100-1	Safety of machinery - Basic concepts, general principles for design – Part 1: Basic terminology, methodology (ISO 12100-1:2003)
EN ISO 12100-2	Safety of machinery - Basic concepts, general principles for design – Part 2: Technical principles (ISO 12100-2:2003)
EN 61241-14	Electrical apparatus for use in the presence of combustible dust – Part 14: Selection and installation (IEC 61241-14:2004)
EN 61241-17	Electrical apparatus for use in the presence of combustible dust – Part 17: Inspection and maintenance of electrical installations in hazardous areas (other than mines) (IEC 61241-17:2005)
BetrSichV	Betriebssicherheitsverordnung National industrial safety regulation and the enclosed Technical Regulations.

A3. Type-examination certificate – Solenoid

Certificate Number
Baseefa02ATEX0199X



Issued 6 February 2003
Page 1 of 3

1 EC - TYPE EXAMINATION CERTIFICATE

**2 Equipment or Protective System Intended for use in Potentially Explosive Atmospheres
Directive 94/9/EC**

3 EC – Type Examination Certificate Number : Baseefa02ATEX0199X

4 Equipment or protective system: The Type D/K XX-XD-XD Solenoids

5 Manufacturer : G.W. Lisk Company Incorporated

6 Address : 2 South Street, Clifton Springs, New York, 14432, USA

7 This equipment and any acceptable variation thereto is specified in the schedule to this certificate and the documents therein referred to.

8 Baseefa (2001) Ltd. Notified body number 1180 in accordance with Article 9 of the Council Directive 94/9/EC of 23 March 1994, certifies that this equipment or protective system has been found to comply with the Essential Health and Safety Requirements relating to the design and construction of equipment and protective systems intended for use in potentially explosive atmospheres given in Annex II to the Directive.

The examination and test results are recorded in confidential Report No. 02(C)0465

9 Compliance with the Essential Health and Safety Requirements has been assured by compliance with:

EN 50014 (1997) + Amendments 1 & 2; EN 50019 (2000); EN 50028 (1987)

except in respect of those requirements listed at item 18 of the Schedule.

10 If the sign “X” is placed after the certificate number, it indicates that the equipment or protective system is subject to special conditions of safe use specified in the schedule to this certificate.

11 This EC - TYPE EXAMINATION CERTIFICATE relates only to the design and construction of the specified equipment or protective system. If applicable, further requirements of this Directive apply to the manufacture and supply of this equipment or protective system.

12 The marking of the equipment or protective system shall include the following :

Ⓔ II 2G EEx me II T (See Schedule) -54°C ≤ T_{amb} ≤ +40°C or -54°C ≤ T_{amb} ≤ +60°C

This certificate may only be reproduced in its entirety, without any change, schedule included.

Baseefa (2001) Ltd. Customer Reference No. 0435

Project File No.02/0465

This certificate is granted subject to the general terms and conditions of Baseefa (2001) Ltd. It does not necessarily indicate that the equipment may be used in particular industries or circumstances.

R S SINCLAIR

**DIRECTOR
On behalf of**

Baseefa (2001) Ltd.

Baseefa (2001) Ltd.

Health and Safety Laboratory Site, Harpur Hill,
Buxton, Derbyshire SK17 9JN

Telephone +44 (0) 1298 28255 Fax +44 (0) 1298 28216

e-mail info@baseefa2001.biz web site www.baseefa2001.biz

Registered in England No. 4305578 at 13 Dovedale Crescent, Buxton,
Derbyshire, SK17 9BJ

Certificate Number
Baseefa02ATEX0199X



Issued 6 February 2003
Page 2 of 3

Schedule

15 Description of Equipment or Protective System

The Type D/K XX-XD-XD Solenoids comprise an encapsulated coil solenoid fitted with an increased safety terminal enclosure. Additionally the Type K solenoids are fitted with a bridge rectifier and a shunt varistor. The coil and components are encapsulated in a glass fibre filled polyester resin.

The solenoid is fitted to a core tube, which contains the solenoid armature. The core tube is provided with a mounting thread to customer specification. The solenoid is retained on the core tube by a spacer and nut.

Internal and external earth facilities are provided.

An M20 cable entry is provided for connection of the users cabling.

The solenoid is designed and rated for mounting on a specified valve body (see sheet 8 of drawing number H17423).

The Type designation represents the following information;

- i) The first character is either D for d.c. input or K for a.c. input.
- ii) The first two digits (10, 12, 13, 14, 15, 16, 17, 18 or 19) identify the diameter of the core tube in 1/16 inches.
- iii) The subsequent 1, 2, 3, or 4 digits identify information specific to the customer. Associated with these digits is the character D which indicates that the coil is an explosion protection design (EEx me).
- iv) The final group of 3 numbers signify the voltage and wattage ratings.

Both d.c. and a.c. versions are fitted with a thermal fuse rated with an operating temperature according to the applicable temperature classification as follows;

- For T6 versions a 75°C rated thermal fuse is fitted.
- For T5 versions a 90°C rated thermal fuse is fitted.
- For T4 versions a 125°C rated thermal fuse is fitted.

The solenoid coil may be wound for use with supplies of up to 250V d.c. (Type D) or 250V a.c. 50Hz or 60Hz (Type K). The maximum stabilized power dissipation for a given maximum ambient temperature and temperature classification for the solenoid mounted on a specified valve body are given in the table below.

MAXIMUM PERMITTED STABILIZED POWER (Watts)

Solenoid Type	Ambient Temperature (°C)	Power (Watts)		
		T6	T5	T4
D10, K10	40	12	18	30
	60	6	11	25
D12, K12, D13, K13, D14, K14, D15, K15	40	13	22	36
	60	4	11	30
D14, K14, D15, K15	40	16	23	39
	60	7	13	30
D16, K16, D17, K17, D18, K18, D19, K19	40	25	37	50
	60	10	22	42

Certificate Number
Baseefa02ATEX0199X



Issued 6 February 2003
Page 3 of 3

16 Report No. 02(C)0465

17 **Special Conditions for Safe Use**

1. The solenoid must only be mounted on a valve body which has a heat dissipation equal to or greater than the valve body shown on sheet 8 of drawing number H17423. The solenoid valve must be complete before the coil is energised.
2. The solenoid and the valve body on which it is mounted must not be thermally lagged.
3. The fluid flowing through the valve must not exceed the specified ambient temperature of 40°C or 60°C.
4. The solenoid shall be protected by fuses rated for a prospective short circuit current of at least 4000A.

18 **Essential Health and Safety Requirements**

None additional to those covered by the standards listed at item 9

19 **Drawings and Documents**

<u>Number</u>	<u>Issue</u>	<u>Date</u>	<u>Description</u>
H17423 sheet 1	A	05 Jun 01	General Arrangement
H17423 sheet 2	A	05 Jun 01	Dimensional Details
H17423 sheet 3	A	05 Jun 01	Terminal Box
H17423 sheet 4	A	05 Jun 01	Circuit Details
H17423 sheet 5	A	05 Jun 01	Coil Details
H17423 sheet 6	A	05 Jun 01	Certification Label
H17423 sheet 7	A	05 Jun 01	Voltage & Power Ratings
H17423 sheet 8	A	05 Jun 01	Heat Sink (Valve Body) Details
H17423 sheet 9	A	05 Jun 01	Encapsulant Details

Certificate Number
Baseefa02ATEX0199X/1



Issued 8th April 2009
Page 1 of 2

1 SUPPLEMENTARY EC - TYPE EXAMINATION CERTIFICATE

**2 Equipment or Protective System Intended for use in Potentially Explosive Atmospheres
Directive 94/9/EC**

3 Supplementary EC - Type Examination Certificate Number: Baseefa02ATEX0199X/1

4 Equipment or Protective System: The Type D/K XX-XD-XD Solenoids

5 Manufacturer: G.W. Lisk Company Incorporated

6 Address: 2 South Street, Clifton Springs, New York 14432, USA

7 This supplementary certificate extends EC - Type Examination Certificate No. Baseefa02ATEX0199X to apply to equipment or protective systems designed and constructed in accordance with the specification set out in the Schedule of the said certificate but having any variations specified in the Schedule attached to this certificate and the documents therein referred to.

This supplementary certificate shall be held with the original certificate.

This certificate may only be reproduced in its entirety, without any change, schedule included.

Baseefa Customer Reference No. 0435

Project File No. 09/0188

This certificate is granted subject to the general terms and conditions of Baseefa. It does not necessarily indicate that the equipment may be used in particular industries or circumstances.

Baseefa

Rockhead Business Park, Staden Lane,
Buxton, Derbyshire SK17 9RZ
Telephone +44 (0) 1298 766600 Fax +44 (0) 1298 766601
e-mail info@baseefa.com web site www.baseefa.com
Baseefa is a trading name of Baseefa Ltd
Registered in England No. 4329578. Registered address as above.



R S SINCLAIR
DIRECTOR
On behalf of
Baseefa

Certificate Number
Baseefa02ATEX0199X/1



Issued 8th April 2009
Page 2 of 2

13 **Schedule**
14 **Certificate Number Baseefa02ATEX0199X/1**

15 **Description of the variation to the Equipment or Protective System**

Variation 1.1

To confirm that the equipment covered by this certificate has been reviewed against the requirements of EN 60079-0: 2006, EN 60079-7: 2007 and EN 60079-18: 2004 in respect of the differences from EN 50014: 1997 + amd. 1 & 2, EN 50019: 2000 and EN 50028: 1987 and that none of these differences in the Standard affects this equipment.

Variation 1.2

To permit minor design and drawing changes.

16 **Report Number**

None

17 **Special Conditions for Safe Use**

None additional to those listed previously

18 **Essential Health and Safety Requirements**

Compliance with the Essential Health and Safety Requirements is not affected by this variation.

19 **Drawings and Documents**

Number	Sheet	Issue	Date	Description
H17423	1	B	20 Feb 09	General arrangement
H17423	2	B	20 Feb 09	Dimensional detail
H17423	3	B	20 Feb 09	Terminal box
H17423	4	B	20 Feb 09	Circuit details
H17423	5	B	20 Feb 09	Coil details
H17423	6	B	20 Feb 09	Certification label
H17423	7	B	20 Feb 09	Voltage and power ratings
H17423	8	B	20 Feb 09	Heat sink (valve body) details
H17423	9	B	20 Feb 09	Encapsulant details

A4. Declaration of conformity - Solenoid



LISK IRELAND LIMITED



Ennis Road, Gort, Co. Galway, Ireland. Telephone: (353) 91-631711, 631101 Fax: (353) 91-633011

MANUFACTURERS STATEMENT

In Relation to:

INGRESS PROTECTION (IP) RATING OF



SOLENOIDS RATED FOR USE IN HAZARDOUS LOCATIONS

SOLENOIDS OF THE FOLLOWING DESIGNATION ARE CERTIFIED TO

HAVE AN

INGRESS PROTECTION RATING OF

IP66 in accordance with BS5490

D10-****D-*, D12-****D-*, D14-****D-*, D15-****D-*,
D16-****D-*, D19-****D-*,
&
K10-****D-*, K12-****D-*, K14-****D-*, K15-****D-*,
K16-****D-*, K19-****D-*,

Engineering Manager.

March 2010.

A5. Mounting instruction cable gland

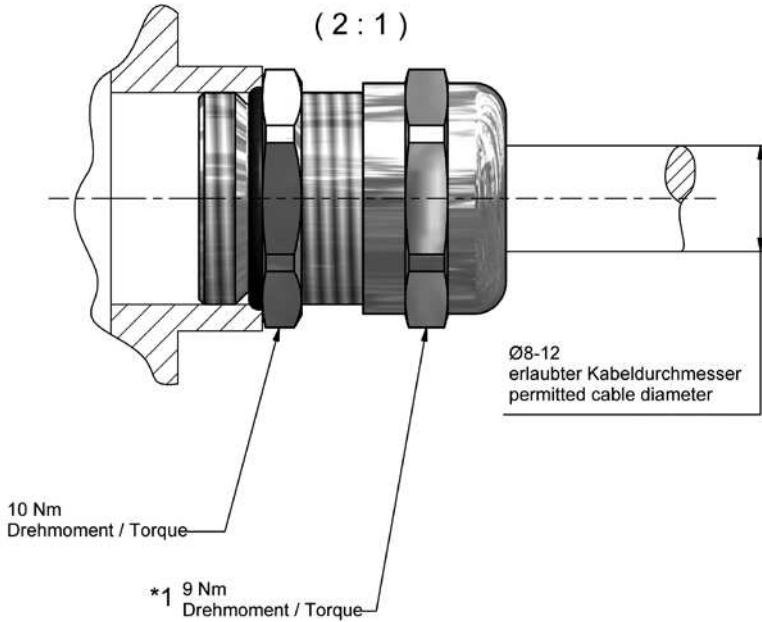

*1 Für Auslieferung handfest angezogen.
For delivery mounted hand-tight.

Supersedes drawing number		Material		Raw part		ChangeECN- Nr. 0919/10	
ISO/R 128 A				Property of PARKER HANNIFIN Not to be used; disclosed; or copied without its written consent. To be returned with all copies upon completion of authorized use.			
				Originator Broeckmann		Date 24.08.2010	
Geometrical tolerancing acc. to DIN ISO 1101				1st. Approver Tschetschko		Date 24.08.2010	
Surface finish acc. to DIN ISO 1302				Scale 2:1		Units mm	
General tolerance acc. to DIN ISO 2768-m K				Title ATEX Kabelverschraubung			
Nominal size range (mm)		1 to 6	>6 to 30	>30 to 120	>120 to 400	>400 to 1000	>1000 to 2000
Tolerance		±0,1	±0,2	±0,3	±0,5	±0,8	±1,2
Sheet		Size		Drawing number		Rev. Prod. Stat.	
1 / 1		A4		5005113		A PR	

