



aerospace  
climate control  
electromechanical  
filtration  
fluid & gas handling  
**hydraulics**  
pneumatics  
process control  
sealing & shielding



# IQAN Accessories

Electronic Control Systems

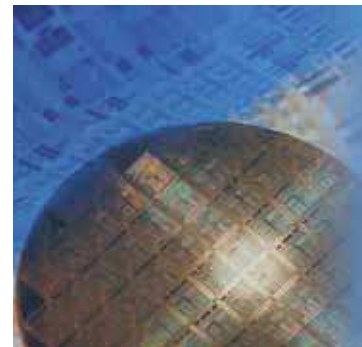

ENGINEERING YOUR SUCCESS.

# Prototype installation cables

**5030025**

C1-cable: 2,5 meters, fits to IQAN-MDL2  
 (with minor modification; phase-out)

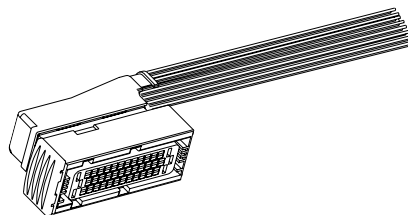

**5030030**

C1-cable: 2,5 meters, fits to IQAN-XP2, -XT2,  
 (-TOC8, -XA2, -XS2, -MC2 with minor modification)

**5030029**

IQAN-MDM cable: 2,5 meters (phase-out)

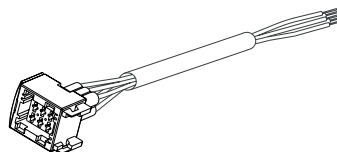

**5030090**

C1-cable: 2,5 meters, fits to IQAN-TOC2

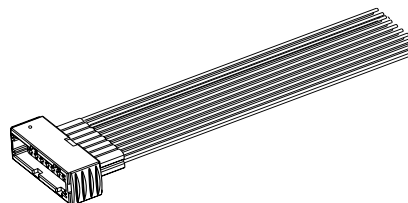

**5030094**

4 pin JPT: 2,5 meters, fits to IQAN-LSL, -LST (-S)

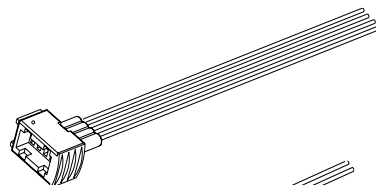

**5030095**

2 pin JPT: 2,5 meters, fits to IQAN-LSL (-S)

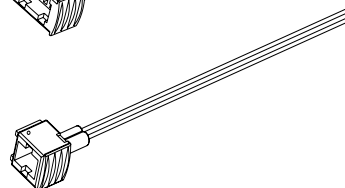

**5030125**

C1-cable: 2,5 meters, fits to IQAN-MD3, -MD4,  
 -G1, -LC5-C0x; Grey, key A

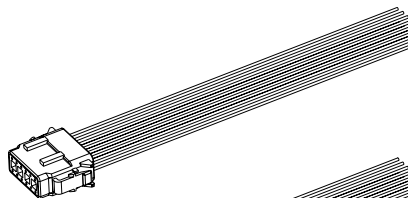

**5030126**

C2-cable: 2,5 meters, fits to IQAN-MD3, -MD4  
 Black, key B

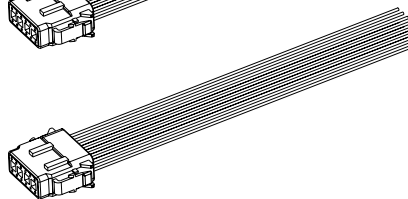

# Prototype installation cables

**5030127**

C1-cable: 2,5 meters, fits to IQAN-LC5-X05,  
-LC5-C0x

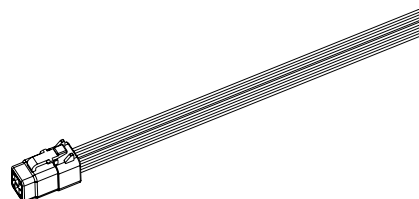

**5030216**

C1-cable: 2,5 meters, fits to IQAN-MC3  
Black, key A (for power, CAN and outputs)

**5030217**

C2-cable: 2,5 meters, fits to IQAN-MC3  
Black, key B (for inputs and VREF)

**5030218**

C3-cable: 2,5 meters, fits to IQAN-MC3  
Black, key C (for inputs and VREF)

**5030219**

C4-cable: 2,5 meters, fits to IQAN-MC3  
Black, key D (for outputs)

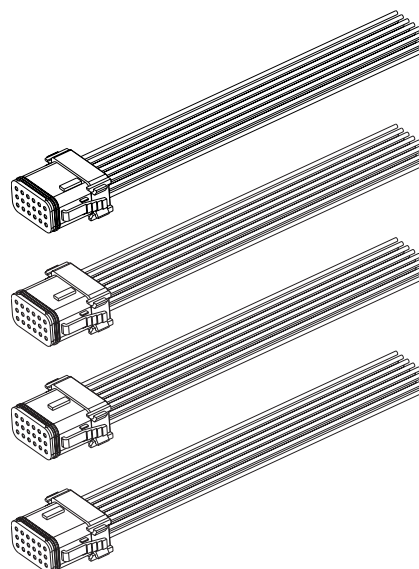

**20077763**

C1-C2 cables: 2,5 meters, fits to IQAN-LC6-X05

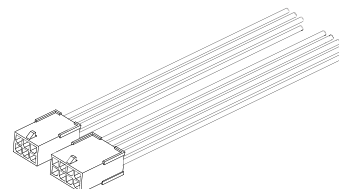

**20077777**

C1-C4 cables: 2,5 meters, fits to IQAN-XC21

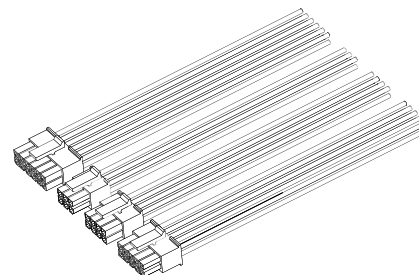

# Communication cables

**5030024**

RS232-cable: 1,5 meters, fits to IQAN-MDM

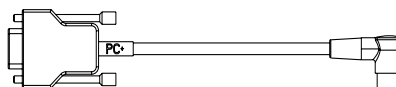

**5030089**

Panel mount serial adapter cable: 1 meter, fits to IQAN-TOC2, -TOC8.  
(Allows use of 5030024)

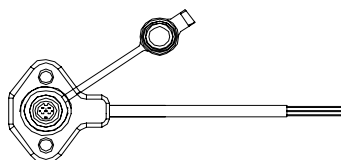

**5030110**

USB cable: 1,5 meters, fits to IQAN-MDL2  
(phase-out)

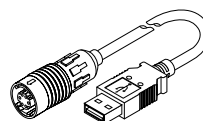

**5030124**

Panel mount USB adapter cable: 0,4 meter, fits to IQAN-MC2, -MD3

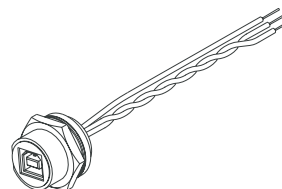

**5030184**

FAKRA to SMA antenna adapter cable: 0,2 meter, fits to IQAN-G1

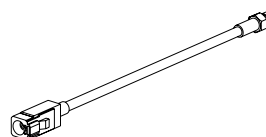

**20077744**

Power/CAN cable: 2,0 meters, fits to IQAN-G2

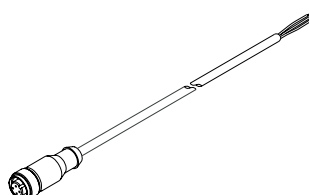

**20077780**

Ethernet cable: 1,5 meters, fits to IQAN-MD4

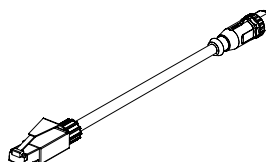

**20077785**

Panel mount Ethernet adapter cable: 1,5 meter, fits to IQAN-MD4

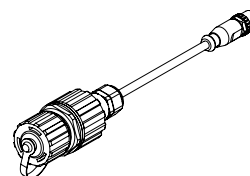

# System cables / miscellaneous

**5030087**  
IQAN-TOC2 + 2x IQAN-LST or LSL (-S), 2.5 meters

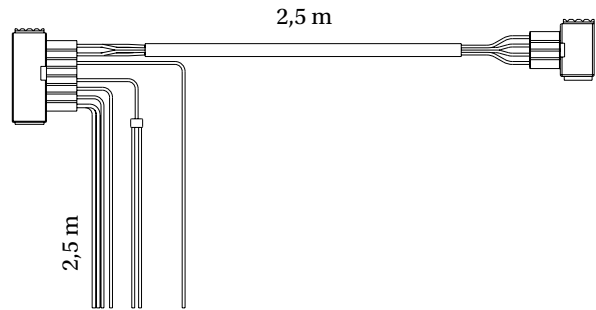

**5030092**  
IQAN-TOC2 + 1x IQAN-LST or LSL (-S), 2.5 meters

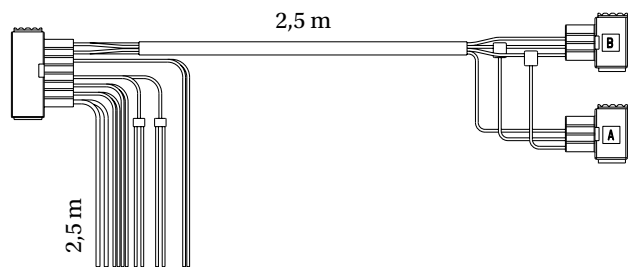

**2830018**  
IQAN-LL to IQAN-LC5-C02 adapter cable,  
for replacing -LL joysticks with -LC5-C02 joysticks  
in existing installations, 0.3 meters

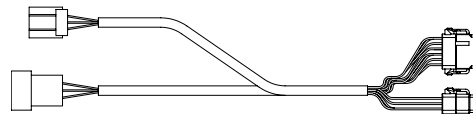

**20077743**  
IQAN-G2 modem antenna, low profile,  
magnetic style with cable and SMA connector,  
for implementing remote diagnostics in IQAN  
systems, 3 meters

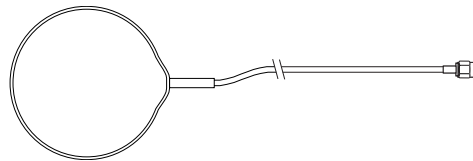

**20077778**  
Steel (painted black) mounting bracket, adapts  
RAM™ or Southco swivel mounts to IQAN-MD4-7.

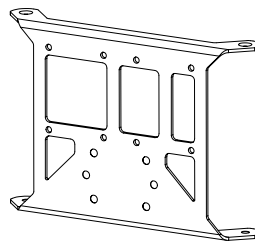

**20077779**  
Steel (painted black) mounting bracket, adapts  
RAM™ or Southco swivel mounts to IQAN-MD4-5.



**20077790**  
Larger plastic ring for 4th axis control of the IQAN-  
LC6-X05 joystick handle. Fits over existing ring.

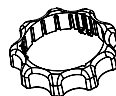

# Address and termination

## Address units (Id-Tags)

AMP/Tyco terminals, fits to IQAN-Lx, -XP2, -XT2, -XA2, -XS2  
 Deutsch DTM terminals, fits to IQAN-LC5-C0x, -MD3, -MD4  
 Deutsch DT terminals, fits to IQAN-MC3, -MC31  
 Molex Micro-Fit 3.0 terminals, fits to IQAN-XC21  
 sold in 10-pack only.

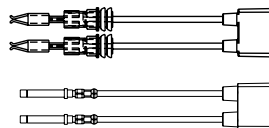

## Address Id-Tags (10 pack)

Address	Resistance (ohms)	AMP/Tyco Ordering No.	Deutsch DTM Ordering No.	Deutsch DT Ordering No.	Molex Micro-Fit Ordering No.
0	294	5030060	5030160	20085050	20085020
1	590	5030061	5030161	20085051	20085021
2	976	5030062	5030162	20085052	20085022
3	1.5K	5030063	5030163	20085053	20085023
4	2.23K	5030064	5030164	20085054	20085024
5	3.36K	5030065	5030165	20085055	20085025
6	5.3K	5030066	5030166	20085056	20085026
7	9.53K	5030067	5030167	20085057	20085027

## Address with termination Id-Tags (10 pack)

Address	Resistance (ohms)	AMP/Tyco Ordering No.	Deutsch DTM Ordering No.	Deutsch DT Ordering No.	Molex Micro-Fit Ordering No.
0T	432	5030070	5030170	20085060	20085030
1T	768	5030071	5030171	20085061	20085031
2T	1.21K	5030072	5030172	20085062	20085032
3T	1.82K	5030073	5030173	20085063	20085033
4T	2.74K	5030074	5030174	20085064	20085034
5T	4.17K	5030075	5030175	20085065	20085035
6T	6.9K	5030076	5030176	20085066	20085036
7T	14K	5030077	5030177	20085067	20085037

## Termination unit

CAN Bus termination, available in all terminal types  
 sold in 10-pack only.

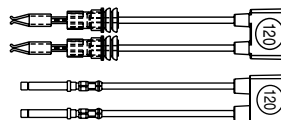

## Termination Tag

Function	Resistance (ohms)	AMP/Tyco Ordering No.	Deutsch DTM Ordering No.	Deutsch DT Ordering No.	Molex Micro-Fit Ordering No.
Termination	120	5030083	5030183	20085068	20085038

# Connector kits

Temperature sensor (legacy)  
Part / Ordering No: **5031007**



Part	pcs.	AMP No.
Housing	1	963040-3
Contact JPT	2	929940-1
Seal JPT	2	828904-1

IQAN-LSL, -LST (-S)  
Part / Ordering No: **5031097**



Part	pcs.	AMP No.
Housing	1	1-963207-1
Contact JPT	4	929940-1
Seal JPT	4	828904-1

IQAN-MDM, -LF1 (phase-out)  
Part / Ordering No: **5031022**



Part	pcs.	AMP No.
Housing	1	1-963212-1
Contact JPT	6	929940-1
Seal JPT	6	828904-1
Cavity plug	1	828922-1

IQAN-LSL-E0-//-Lx (-S)  
IQAN-LSL-E1-//-// (-S)  
(switch or detent options)  
Part / Ordering No: **5031098**



Part	pcs.	AMP No.
Housing	1	1-963210-1
Contact JPT	2	929940-1
Seal JPT	2	828904-1

IQAN-LL, -LM (phase-out)  
Part / Ordering No: **5031048**

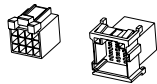

Part	pcs.	AMP No.
Housing	1	1-967622-1
Contact JPT	10	927779-1
Housing	1	1-967627-2
Contact JPT	12	2-963745-1
Second lock	2	967632-1

IQAN-TOC2  
Part / Ordering No: **5031105**

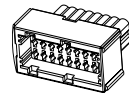

Part	pcs.	AMP No.
Housing	1	1-963217-1
Contact JPT	16	929940-1
Seal JPT	16	828904-1

IQAN-X\_2, -TOC8, -MDL2, -MC2  
Part / Ordering No: **5031063**



Part	pcs.	AMP No.
Housing	1	1-963226-1
Contact JPT	6	929929-1
Contact MT	36	963711-2
Seal JPT	6	828905-1
Seal MT	36	963530-1
Cover	1	962371-1

IQAN-LSL, -LST (-D)  
Part / Ordering No: **5031113**

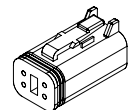

Part	pcs.	Deutsch No.
Housing	1	DT06-4S-C015
Wedge	1	W4S-P012
Contact	4	1062-16-0122

IQAN-SP035, -SP500, -ST (-B)  
Part / Ordering No: **5031086**



Part	pcs.	AMP No.
Housing	1	282191-1
Contact JPT	3	929940-1
Seal JPT	3	828904-1

Sensors: FP4000, ATS90  
Part / Ordering No: **5035012**

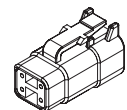

Part	pcs.	Deutsch No.
Housing	1	DTM06-4S
Wedge	1	WM4S
Contact	4	1062-20-0222
Seal plug	4	0413-204-2005

# Connector kits

IQAN-LSL-E0-//-Lx (-D)  
IQAN-LSL-E1-//-// (-D)  
(switch or detent option)  
Part / Ordering No: **5035014**

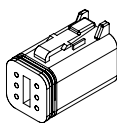

Part	pcs.	Deutsch No.
Housing	1	DT06-6S-CE06
Wedge	1	W6S-P012
Contact	6	1062-16-0122

IQAN-LSL-E1-//-Lx (-D)  
(switch and detent options)  
Part / Ordering No: **5035015**

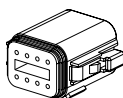

Part	pcs.	Deutsch No.
Housing	1	DT06-08SA-CE06
Wedge	1	W8S-P012
Contact	8	1062-16-0122

IQAN-MD3, -MD4, C1 & C2,  
grey & black  
Part / Ordering No: **20073081**

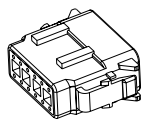

Part	pcs.	Deutsch No.
Housing	1	DTM06-12SA
Housing	1	DTM06-12SB
Wedge	2	WM12S
Contact	24	1062-20-0222
Seal plug	24	0413-204-2005

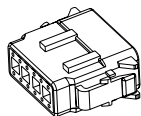

IQAN-G1, C1, grey  
Part / Ordering No: **20072406**

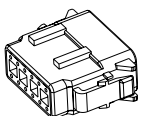

Part	pcs.	Deutsch No.
Housing	1	DTM06-12SA
Wedge	1	WM12S
Contact	12	1062-20-0222
Seal plug	12	0413-204-2005

IQAN-LC5-X05, C1  
IQAN-LC5-C0x, C1 or C3  
Sensors: RS60, RS70, ACC100  
Part / Ordering No: **20072408**

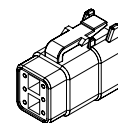

Part	pcs.	Deutsch No.
Housing	1	DTM06-6S
Wedge	1	WM6S
Contact	6	1062-20-0222
Seal plug	6	0413-204-2005

IQAN-LC5-C0x, C1, C2 & C3  
Part / Ordering No: **5035007**

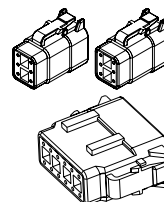

Part	pcs.	Deutsch No.
Housing	2	DTM06-12SA
Wedge	2	WM6S
Housing	1	DTM06-12SA
Wedge	1	WM12S
Contact	24	1062-20-0222
Seal plug	24	0413-204-2005

Sensors: FP2000, FP3000, RM50  
Part / Ordering No: **5035010\***

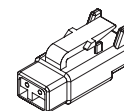

Part	pcs.	Deutsch No.
Housing	1	DTM06-2S
Wedge	1	WM2S
Contact	2	1062-20-0222

\* -same as kit 01786ECD

Sensors: RF50, RF55, RS52, RS53,  
GS50, GS60, ATS50, ADS50, ACC50  
Part / Ordering No: **5035011\***

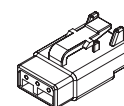

Part	pcs.	Deutsch No.
Housing	1	DTM06-3S
Wedge	1	WM3S
Contact	3	1062-20-0222

\* -same as kit 01787ECD



# Connector kits

IQAN-MC3, -MC31, C1-C4  
Part / Ordering No: **5035016**

Part	pcs.	Deutsch No.
Housing	2	DT16-18SA
Housing	2	DT16-18SB
Housing	1	DT16-18SC
Housing	1	DT16-18SD
Contact	72	1062-16-0122
Seal plug	24	114017

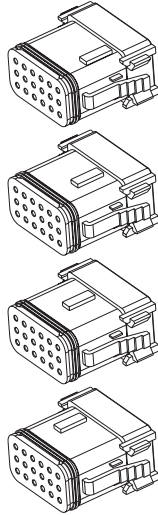

IQAN-LC6-X05, C1-C2  
Part / Ordering No: **2007764**

Part	pcs.	Molex No.
Housing	1	43020-0801
Housing	1	43020-0601
Contact	14	43031-0008

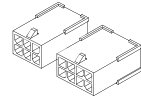

IQAN-XC21, C1-C4  
Part / Ordering No: **2007776**

Part	pcs.	Molex No.
Housing	1	43025-1000
Housing	1	43025-0800
Housing	1	43025-0600
Housing	1	43025-1200
Contact	36	43030-0008

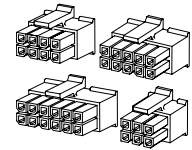

IQAN-LC5-X05-MP handle, 6 position  
Part / Ordering No: **5035017**

Part	pcs.	Deutsch No.
Housing	1	DTM04-6P
Wedge	1	WM6P
Contact	6	1060-20-0222
Seal plug	6	0413-204-2005

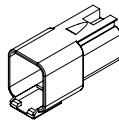

IQAN-LC5-X05-MP handle, 12 position  
Part / Ordering No: **5035018**

Part	pcs.	Deutsch No.
Housing	1	DTM04-12PA
Wedge	1	WM12P
Contact	12	1060-20-0222
Seal plug	12	0413-204-2005

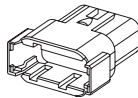

# Crimping tools

## 5031061 IQAN tool kit

Consists of	use	Color	Part No.
Crimp tool	JPT* no seal	Yellow	5031049 <sup>1)</sup>
Crimp tool	JPT* with seal	Red	5031050 <sup>1)</sup>
Crimp tool	MT** seal/no seal	Blue	5031051 <sup>1)</sup>
Extraction tool kit	All types	All	5035003 <sup>2)</sup>
Pin box	Spare parts	All	5031057 <sup>2)</sup>



\* Junior Power Timer, \*\* Micro Timer

<sup>1)</sup>Not available as separate items, only part of IQAN tool kit

<sup>2)</sup>Available as separate item

## 5035003 Extraction tool kit, included in IQAN tool kit

Consists of	use	Color	Part No.
Extraction tool	JPT*	Yellow	5031053 <sup>1)</sup>
Extraction tool	JPT* (for single latch CAN or Sensor connectors)	Red	5031054 <sup>1)</sup>
Extraction tool	MT**	Blue	5031055 <sup>1)</sup>



\* Junior Power Timer, \*\* Micro Timer

<sup>1)</sup>Not available as separate items, only part of Extraction tool kit

## 5031057 Pin box, included in IQAN tool kit

Includes pin	Wire size	pcs.	AMP No.
JPT* no seal	0.75 mm <sup>2</sup> (18 AWG)	50	927779-1 <sup>1)</sup>
JPT* no seal	1.5 mm <sup>2</sup> (14 AWG)	25	927777-1 <sup>1)</sup>
JPT* with seal	0.75 mm <sup>2</sup> (18 AWG)	50	929940-1 <sup>1)</sup>
JPT* with seal	1.5 mm <sup>2</sup> (14 AWG)	25	929938-1 <sup>1)</sup>
JPT* with seal	0.75 mm <sup>2</sup> (18 AWG)	25	2-963745-1 <sup>1)</sup>
JPT* seal	0.75 mm <sup>2</sup> (18 AWG)	50	828904-1 <sup>1)</sup>
JPT* seal	1.5 mm <sup>2</sup> (14 AWG)	25	828905-1 <sup>1)</sup>
JPT* plug	n/a	25	828922-1 <sup>1)</sup>
MT** no seal	0.75 mm <sup>2</sup> (18 AWG)	100	962945-2 <sup>1)</sup>
MT** with seal	0.75 mm <sup>2</sup> (18 AWG)	100	963711-2 <sup>1)</sup>
MT** seal	0.75 mm <sup>2</sup> (18 AWG)	100	963530-1 <sup>1)</sup>
MT** plug	n/a	100	963531-1 <sup>1)</sup>



\* Junior Power Timer, \*\* Micro Timer

<sup>1)</sup>Not available as separate items, only part of Pin box

# Software

## IQANdevelop platform

Contents of software package	Part No. 20005604 Read	Part No. 20005606 Change	Part No. 20004179 Develop	Part No. 20005607 PRO
software USB flash drive	X	X	X	X
software licence no.	X	X	X	X
IQANsimulate software				X

Software IQANdevelop Read is also available in a version without licence no. from our website.  
Printed user manual is not included. PDF documents are contained in the installation files.

## IQANdesign platform IQAN Studio softwares

Contents of software package	Part No. 20073643 IQAN Creative Studio	Part No. 20073644 IQAN Productive Studio	Part No. 20073642 IQAN Active Studio
software USB flash drive	X	X	X
software licence no.	X	X	X

Communication cables are not included. Please choose cables to fit your requirements from page 4.  
Printed user manuals are not included. PDF documents are contained in the installation files.

### **WARNING**

**FAILURE OR IMPROPER SELECTION OR IMPROPER USE OF THE PRODUCTS AND/OR SYSTEMS DESCRIBED HEREIN OR RELATED ITEMS CAN CAUSE DEATH, PERSONAL INJURY AND PROPERTY DAMAGE.**

This document and other information from Parker Hannifin Corporation, its subsidiaries and authorized distributors provide product and/or system options for further investigation by users having technical expertise. It is important that you analyze all aspects of your application, including consequences of any failure, and review the information concerning the product or system in the current product catalogue. Due to the variety of operating conditions and applications for these products or systems, the user, through its own analysis and testing, is solely responsible for making the final selection of the products and systems and assuring that all performance, safety and warning requirements of the application are met.

The products described herein, including without limitation, product features, specifications, designs, availability and pricing, are subject to change by Parker Hannifin Corporation and its subsidiaries at any time without notice.

### **Offer of Sale**

Please contact your Parker representation for a detailed "Offer of Sale".

# Parker Worldwide

## Europe, Middle East, Africa

**AE – United Arab Emirates,** Dubai

Tel: +971 4 8127100  
parker.me@parker.com

**AT – Austria,** Wiener Neustadt

Tel: +43 (0)2622 23501-0  
parker.austria@parker.com

**AT – Eastern Europe,** Wiener Neustadt

Tel: +43 (0)2622 23501 900  
parker.easteurope@parker.com

**AZ – Azerbaijan,** Baku

Tel: +994 50 22 33 458  
parker.azerbaijan@parker.com

**BE/LU – Belgium,** Nivelles

Tel: +32 (0)67 280 900  
parker.belgium@parker.com

**BG – Bulgaria,** Sofia

Tel: +359 2 980 1344  
parker.bulgaria@parker.com

**BY – Belarus,** Minsk

Tel: +48 (0)22 573 24 00  
parker.poland@parker.com

**CH – Switzerland,** Etoy

Tel: +41 (0)21 821 87 00  
parker.switzerland@parker.com

**CZ – Czech Republic,** Klecany

Tel: +420 284 083 111  
parker.czechrepublic@parker.com

**DE – Germany,** Kaarst

Tel: +49 (0)2131 4016 0  
parker.germany@parker.com

**DK – Denmark,** Ballerup

Tel: +45 43 56 04 00  
parker.denmark@parker.com

**ES – Spain,** Madrid

Tel: +34 902 330 001  
parker.spain@parker.com

**FI – Finland,** Vantaa

Tel: +358 (0)20 753 2500  
parker.finland@parker.com

**FR – France,** Contamine s/Arve

Tel: +33 (0)4 50 25 80 25  
parker.france@parker.com

**GR – Greece,** Athens

Tel: +30 210 933 6450  
parker.greece@parker.com

**HU – Hungary,** Budaoers

Tel: +36 23 885 470  
parker.hungary@parker.com

**IE – Ireland,** Dublin

Tel: +353 (0)1 466 6370  
parker.ireland@parker.com

**IT – Italy,** Corsico (MI)

Tel: +39 02 45 19 21  
parker.italy@parker.com

**KZ – Kazakhstan,** Almaty

Tel: +7 7273 561 000  
parker.easteurope@parker.com

**NL – The Netherlands,** Oldenzaal

Tel: +31 (0)541 585 000  
parker.nl@parker.com

**NO – Norway,** Asker

Tel: +47 66 75 34 00  
parker.norway@parker.com

**PL – Poland,** Warsaw

Tel: +48 (0)22 573 24 00  
parker.poland@parker.com

**PT – Portugal,** Leca da Palmeira

Tel: +351 22 999 7360  
parker.portugal@parker.com

**RO – Romania,** Bucharest

Tel: +40 21 252 1382  
parker.romania@parker.com

**RU – Russia,** Moscow

Tel: +7 495 645-2156  
parker.russia@parker.com

**SE – Sweden,** Spånga

Tel: +46 (0)8 59 79 50 00  
parker.sweden@parker.com

**SK – Slovakia,** Banská Bystrica

Tel: +421 484 162 252  
parker.slovakia@parker.com

**SL – Slovenia,** Novo Mesto

Tel: +386 7 337 6650  
parker.slovenia@parker.com

**TR – Turkey,** Istanbul

Tel: +90 216 4997081  
parker.turkey@parker.com

**UA – Ukraine,** Kiev

Tel: +48 (0)22 573 24 00  
parker.poland@parker.com

**UK – United Kingdom,** Warwick

Tel: +44 (0)1926 317 878  
parker.uk@parker.com

**ZA – South Africa,** Kempton Park

Tel: +27 (0)11 961 0700  
parker.southafrica@parker.com

## North America

**CA – Canada,** Milton, Ontario

Tel: +1 905 693 3000

**US – USA,** Cleveland

(industrial)  
Tel: +1 216 896 3000

**US – USA,** Elk Grove Village

(mobile)  
Tel: +1 847 258 6200

## Asia Pacific

**AU – Australia,** Castle Hill

Tel: +61 (0)2-9634 7777

**CN – China,** Shanghai

Tel: +86 21 2899 5000

**HK – Hong Kong**

Tel: +852 2428 8008

**ID – Indonesia,** Tangerang

Tel: +62 21 7588 1906

**IN – India,** Mumbai

Tel: +91 22 6513 7081-85

**JP – Japan,** Fujisawa

Tel: +81 (0)4 6635 3050

**KR – South Korea,** Seoul

Tel: +82 2 559 0400

**MY – Malaysia,** Shah Alam

Tel: +60 3 7849 0800

**NZ – New Zealand,** Mt Wellington

Tel: +64 9 574 1744

**SG – Singapore**

Tel: +65 6887 6300

**TH – Thailand,** Bangkok

Tel: +662 186 7000

**TW – Taiwan,** New Taipei City

Tel: +886 2 2298 8987

**VN – Vietnam,** Ho Chi Minh City

Tel: +84 8 3999 1600

## South America

**AR – Argentina,** Buenos Aires

Tel: +54 3327 44 4129

**BR – Brazil,** Cachoeirinha RS

Tel: +55 51 3470 9144

**CL – Chile,** Santiago

Tel: +56 2 623 1216

**MX – Mexico,** Toluca

Tel: +52 72 2275 4200

Ed. 2015-04-21



### EMEA Product Information Centre

Free phone: 00 800 27 27 5374

(from AT, BE, CH, CZ, DE, DK, EE, ES, FI, FR, IE, IL, IS, IT, LU, MT, NL, NO, PL, PT, RU, SE, SK, UK, ZA)

### US Product Information Centre

Toll-free number: 1-800-27 27 537

www.parker.com

Your local authorized Parker distributor