

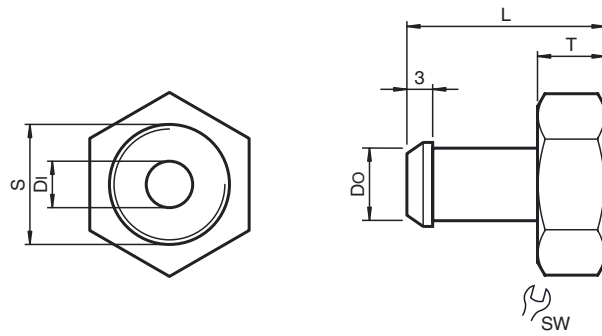

Dimensions



Model Number

SM 30

Cable protector

Features

- Cable Protector

Technical data

Mechanical specifications

Material	
Housing	Stainless steel 1.4305 / AISI 303
Seal	NBR

Technical details

Cable protectors protect the connecting cable from physical damage.

		Order code: SM 8	SM 12	SM 18	SM 30
Dimensions					
Length	L [mm]	20	24	24	24
Thickness	T [mm]	6	8	8	8
Thread	S	M8 x 1	M12 x 1	M18 x 1	M30 x 1.5
Internal diameter	DI [mm]	7	7	9	12.5
External diameter	DO [mm]	8	10	10	14
Width across the flats	SW	10	14	19	32

Release date: 2013-12-18 16:50 Date of issue: 2013-12-18 011513_eng.xml