

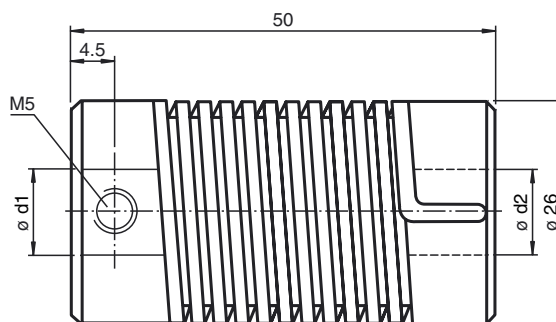

Dimensions



Model Number

9401 12*12

Spring steel coupling

Features

- Universally suitable for backlash-free rotation transmission
- Highly vibration-isolating
- Well misalignment compensation
- Low torsion spring stiffness
- Small reset forces
- No movable parts
- Very rugged construction

Technical data

Ambient conditions

Operating temperature -30 ... 120 °C (-22 ... 248 °F)

Mechanical specifications

Shaft diameter d1 = 12 mm , d2 = 12 mm

Material

Spring spring steel, nickel plated

End piece Diecast zinc

Mass 100 g

Rotational speed max. 3000 min

Max. torque 1.5 Nm

Tightening torque, fastening screws 1.2 Nm

Radial offset max. ± 1.5 mm

Axial offset max. ± 1 mm

Angle error max. ± 5 °

Torsion angle at torque 0.75 Nm drive shaft view

CW rotation direction 40 °

CCW rotation direction 60 °

Moment of inertia 95 kg m² x 10⁻⁷

Mounting clamp screws M5 x 6, DIN 916

Tightening torque of clamping screws max. 3 Nm