

MLV11-8-500/48/112

Diffuse mode sensor

MLV11-8-500/48/112

with 5-pin M12 connector, 90° adjustable position

CE

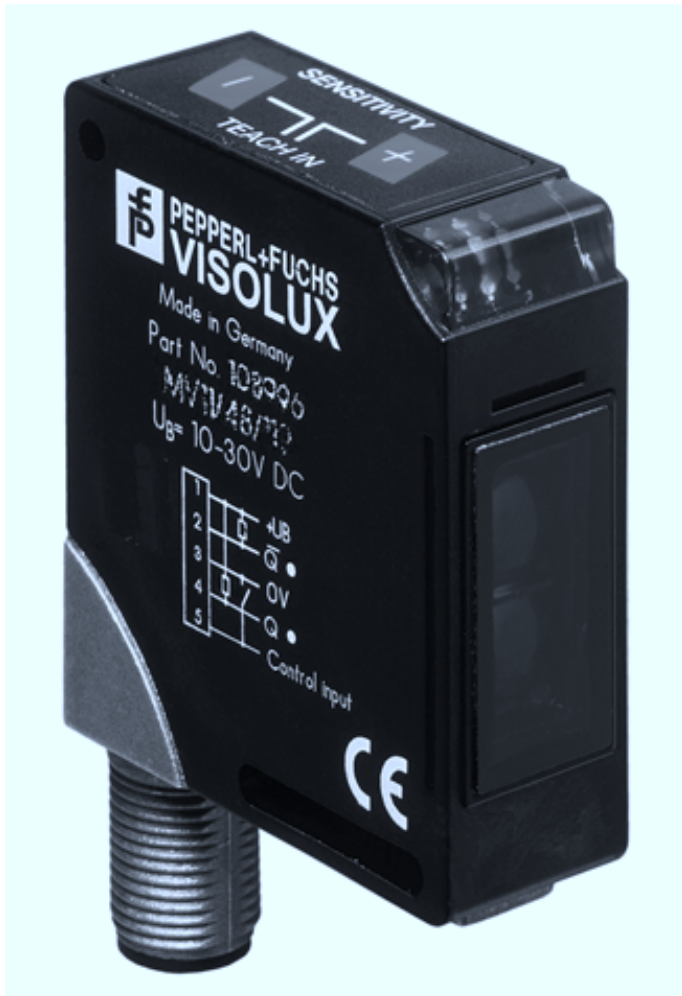

- ◆ Visible red light
- ◆ Automatic adjustment of switching points (sensitivity) via TEACH-IN
- ◆ Multifunction input
- ◆ Parameterisation via optical communication link (e.g. optional time increments)
- ◆ Protection degree IP68

General specifications

Detection range	0 ... 500 mm adjustable
Light source	LED
Approvals	CE
Adjustment range	50 ... 500 mm
Reference target	standard white 100 mm x 100 mm
Light type	red, modulated light
Diameter of the light spot	25 mm at a distance of 500 mm
Ambient light limit	10000 Lux

Indicators/operating means

Operating display	LED green
Function display	TEACH-IN: LED green flashing switching state: LED yellow pre-fault indicator: LED red flashing
Operating elements	membrane keys for setting sensitivity and TEACH IN

Electrical specifications

Operating voltage	10 ... 30 V DC
Ripple	10 %
No-load supply current I_0	≤ 25 mA
Time delay before availability t_v	≤ 80 ms

Input

Test input	inactive: ≥ 7 V or unwired; active: ≤ 3 V
------------	---

Output

Output of the pre-fault indication	npn, dynamic/static configurable
Switching type	light/dark switching
Signal output	2 switch outputs npn, parameterisable as - NO/NC (antivalent) - NO and pre-fault indication - NC and pre-fault indication
Switching voltage	max. 30 V DC
Switching current	max. 200 mA
Voltage drop U_d	≤ 2.5 V
Switching frequency f	≤ 1000 Hz
Response time	≤ 0.5 ms
Timer function	parameterisable

Standard conformity

Standards	EN 60947-5-2
-----------	--------------

Ambient conditions

Ambient temperature	-25 ... 70 °C (248 ... 343 K)
Storage temperature	-40 ... 70 °C (233 ... 343 K)

Mechanical specifications

Protection degree	IP68
Connection	5-pin M12 x 1 connector, 90° adjustable position
Material	
Housing	PBT
Optical face	scratch resistant plastic pane
Mass	60 g

Release date: 2006-10-17 18:36 Date of issue: 2006-10-17 109123_ENG.xml

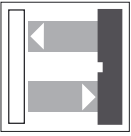

MLV11-8-500/48/112

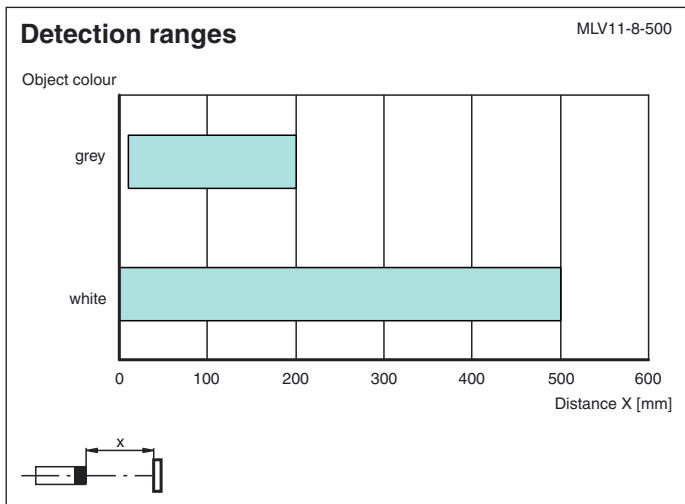
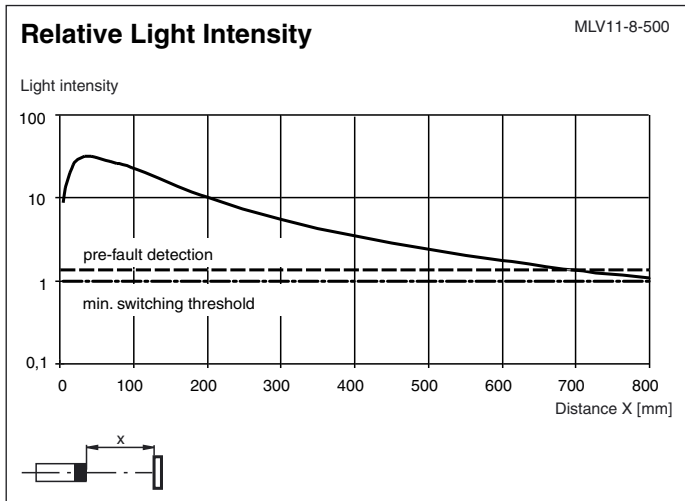
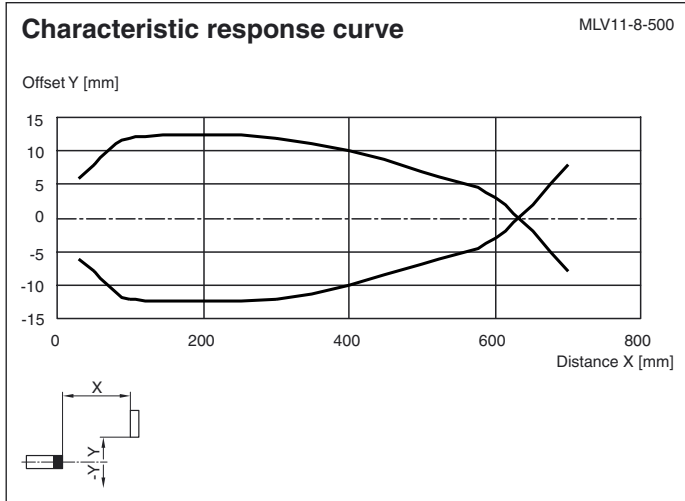

Release date: 2006-10-17 18:36 Date of issue: 2006-10-17 109123_ENG.xml

Dimensions

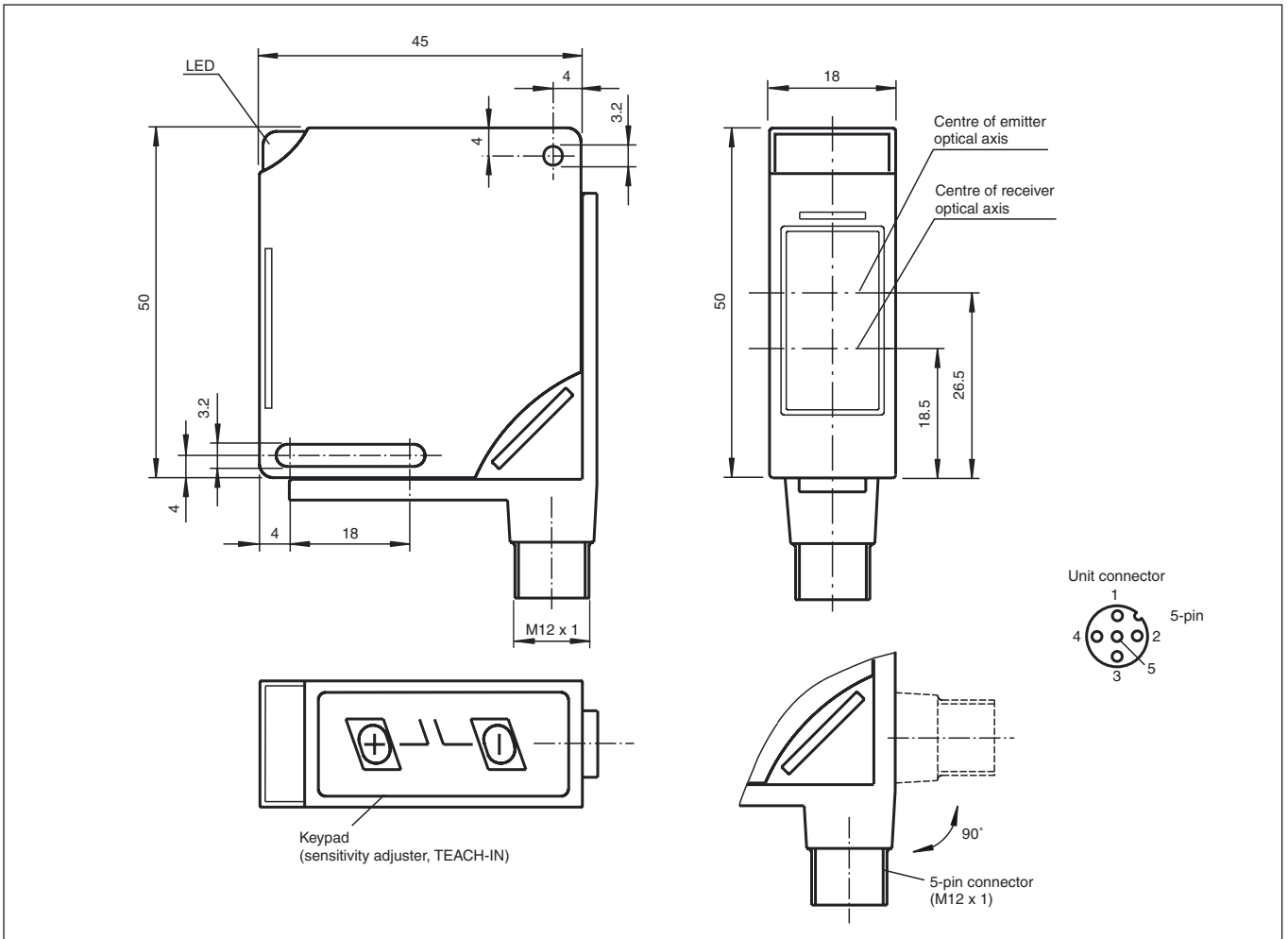

Electrical connection

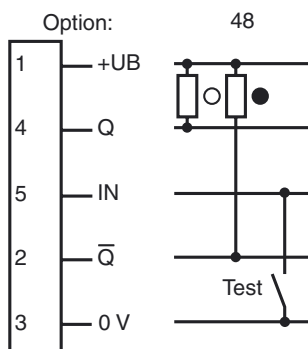

○ = light on, ● = dark on