

Model Number

UB1500-F42-UK-V95

Single head system

Features

- Relay output for high power
- Extremely small unusable area
- TEACH-IN
- Interference suppression (adjustable divergence of sound cone in close range)
- Temperature compensation
- NO/NC selectable

Diagrams

Characteristic response curve

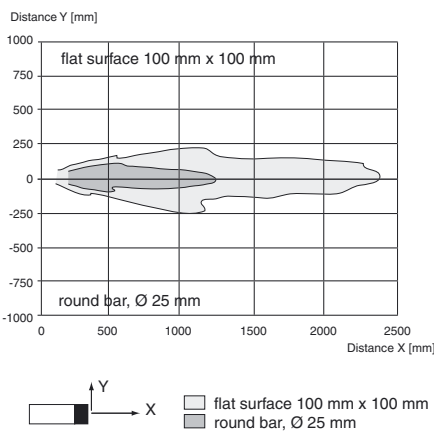

Release date: 2012-03-29 13:54 Date of issue: 2014-12-12 111683_eng.xml

Technical data

General specifications	
Sensing range	70 ... 1500 mm
Adjustment range	90 ... 1500 mm
Unusable area	0 ... 70 mm
Standard target plate	100 mm x 100 mm
Transducer frequency	approx. 175 kHz
Response delay	approx. 150 ms
Indicators/operating means	
LED green	solid green: Power on
LED yellow	solid: switching state switch output flashing: program function
LED red	normal operation: "fault" program function: no object detected
Electrical specifications	
Operating voltage U_B	20 ... 253 V AC/DC
No-load supply current I_0	≤ 60 mA
Output	
Output type	1 relay output
Rated operating current I_o	3 A
Repeat accuracy	≤ 0.5 % of switching point
Switching frequency f	≤ 3 Hz
Range hysteresis H	1 % of the set operating distance
Temperature influence	± 1 % of full-scale value
Ambient conditions	
Ambient temperature	-25 ... 70 °C (-13 ... 158 °F)
Storage temperature	-40 ... 85 °C (-40 ... 185 °F)
Mechanical specifications	
Degree of protection	IP65
Connection	5-pin V95 connector (7/8"-16 UN 2A)
Material	
Housing	PBT
Transducer	epoxy resin/hollow glass sphere mixture; foam polyurethane, cover PBT
Mass	
Mass	260 g
Compliance with standards and directives	
Standard conformity	
Standards	EN 60947-5-2:2007 IEC 60947-5-2:2007

Dimensions

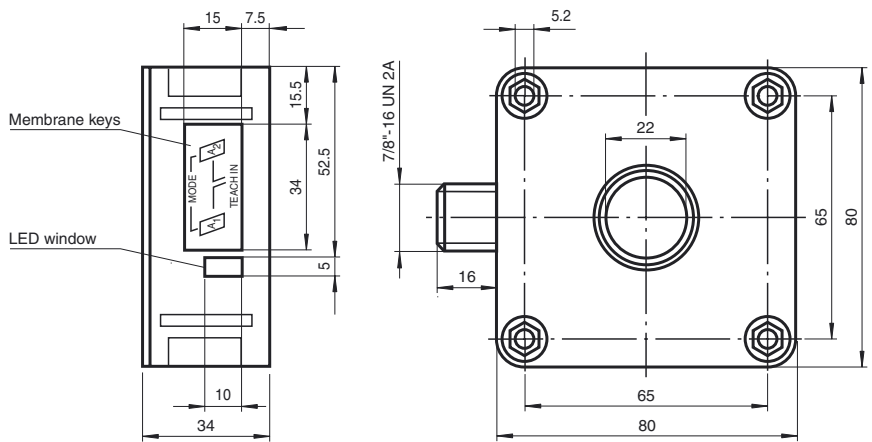

Electrical Connection

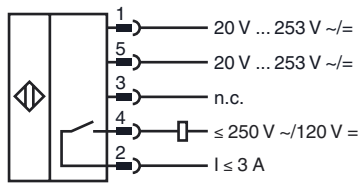

Pinout

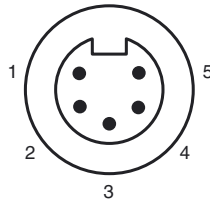

Accessories

V95-G-Y
Female connector, 7/8" - 16 UN, 5-pin, field attachable

V95-W-5M-PVC
Female cordset, 7/8", 5-pin, PVC cable

V95-W
Female cordset, field attachable

V95-W-2M-PVC
Female cordset, 7/8", 5-pin, PVC cable

MH 04-3505
Mounting aid for FP and F42 sensors

MHW 11
Mounting brackets for sensors

Safety notes:

The supply circuit is separated from the relay circuit by basic insulation.

Safety class II is only guaranteed when using cable connectors listed in the accessories. The connector cable may only be separated from the unit when the power is off.



CAUTION:

The UB...-F42(S)-UK-V95 ultrasonic sensor is not suitable for use in environments subject to explosion hazards.

Conformity: EN 60947-5-2
Housing insulation: Safety class II
Degree of contamination: 3
Overvoltage category: III

Parameterisation:

You can use 2 keys to parameterise the sensor. In order to start the switch point 1 learning mode, press the A1 key; in order to start the switch point 2 learning mode, press the A1 key.

If you keep both keys pressed as you switch on the power supply, the sensor will switch over to the sensitivity adjustment mode of operation.

In case the parameterisation procedure is not completed within 5 minutes, the sensor will discontinue the process and retain all previous settings.

Additional Information

Possible operating modes

1. Switch point operation

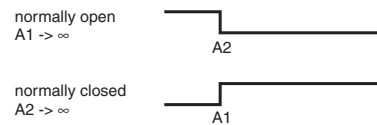

2. Window operation

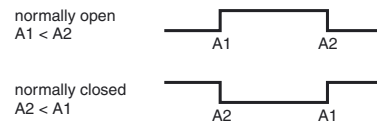

3. Hysteresis operation

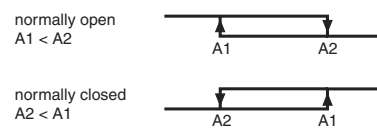

4. Object presence detection mode

A1 -> ∞, A2 -> ∞: Sensor detects object presence within sensing range

Note A1 -> ∞, A2 -> ∞ means: cover sensor with hand or remove all objects from sensing range

Teaching in switch points:

Teaching in A1 switch point by pressing A1 key.

- Keep A1 key pressed for > 2 s The sensor enters the switch point 1 learning mode
- Position target object in the desired distance The sensor indicates via LED lights whether the target object has been detected. In case the object has been detected, the yellow LED will flash; if the object has not been detected, the red LED flashes.
- Briefly press the A1 key The sensor completes the switch point 1 TEACH-IN process and saves this value in non-volatile memory. In the event of an uncertain object (flashing red LED), the value learned is invalid. The system exits the TEACH-IN mode.

Analogously, the A2 switch point is learned in the same fashion as described above using the A2 key.

Switching hysteresis operation mode <--> switch point/window operation mode:

- Keep both A1 and A2 keys pressed The sensor indicates the current operation mode through the green LED.
 permanent green: Switch point/window operation mode
 flashing green: Hysteresis operation mode
- after 2 seconds: The sensor changes the operation mode which can be identified through the green LED.
 permanent green: Switch point/window operation mode
 flashing green: Hysteresis operation mode
- Release keys The green LED of the sensor keeps indicating the operation mode selected for additional 5 seconds

Suppression of disturbing targets

Some types of installation or particular conditions during operation of an ultrasonic sensor may admit that undesired objects (such as shelf brow posts, edges of machines) are closer than the actual target as they enter the recording range. In this case, the sensor would normally detect these objects rather than the desired target. So in order to ensure an error-free operation, it may be necessary to suppress those objects.

Objects can be suppressed if they meet the following conditions:

- The disturbing target must not hide the actual target completely.
- The amplitude of the disturbing signal must be smaller than the amplitude of the desired signal.
- The disturbing target must remain in the edge region of the sound lobe and must not enter its center.

Sound lobe

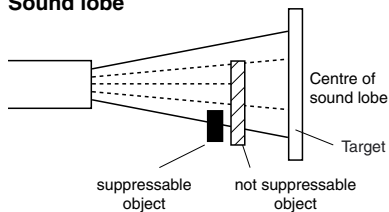

The suppression of the disturbing target is effected through reduction of the response sensitivity. This figure shows its effect on the response characteristics of the sensor. The sensor is preset on step 1 by the manufacturer.

Release date: 2012-03-29 13:54 Date of issue: 2014-12-12 111683_eng.xml

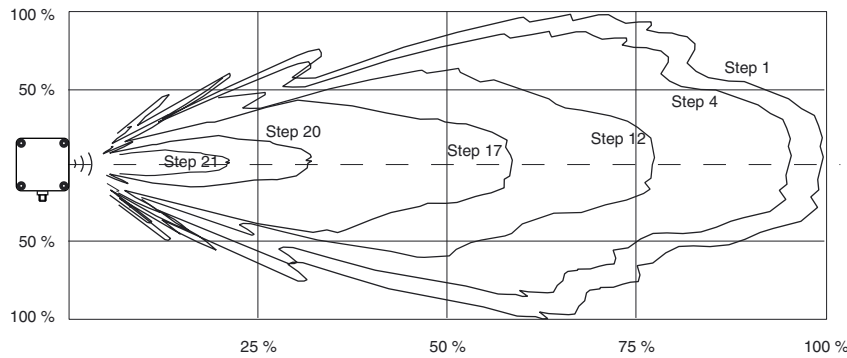

Sensitivity adjustment for suppression of disturbing targets

Remove the actual target object from the detection range.

- Keep A1 and A2 keys pressed as you switch on power supply

The sensor enters the sensitivity adjustment mode of operation.
The sensor sensitivity can be adjusted in 24 steps.
Step 1 = high response
Step 24 = low response
- Briefly press the A1 key

Response is increased. The LED lights indicate the actual state of the sensor.

 - flashing red: no disturbing target detected
 - flashing yellow: disturbing target detected
 - permanent red: upper setting limit is reached.
- Briefly press the A2 key

Response is decreased. The LED lights indicate the actual state of the sensor.

 - flashing red: no disturbing target detected
 - flashing yellow: disturbing target detected
 - permanent red: lower setting limit is reached.
- Press both A1 and A2 keys at once

Exiting sensitivity adjustment. The sensor response is saved in non-volatile memory.
In the event the sensitivity adjustment is not exited through this procedure, the sensor will exit this operation mode automatically after 5 minutes, and the previous sensitivity value remains valid.

Release date: 2012-03-29 13:54 Date of issue: 2014-12-12 111683_eng.xml