

Model Number

SLPC10-2

with 2 separate fail-safe semiconductor outputs

Features

- Sensing range up to 10 m
- 2-radial design
- Beam spacing 500 mm
- Self-monitoring (type 4 according to IEC/EN 61496-1)
- Red transmission light
- Usable with or without start/restart disable
- Integrated relay monitor
- 7-segment diagnostic display
- Integrated function display
- Pre-fault indication
- OSSD outputs as semiconductor or relay outputs

Accessories

PG SLP-2

Protective glass panes for SLP series

Dimensions

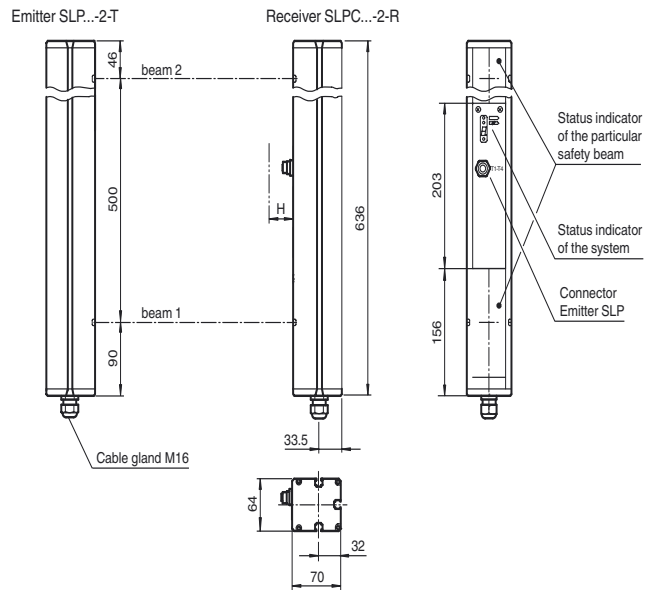

Electrical connection

Emitter SLP

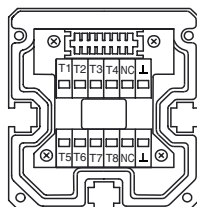

T1 - Emitter channel 1
T2 - Emitter channel 2
L - 0 V

Receiver SLPC

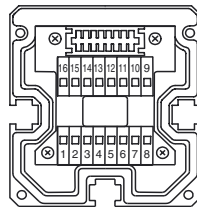

Receiver SLPC (semiconductor outputs)	Receiver SLPC/31 (Relay outputs)
4 - n.c.	1 - Functional earth
5 - -	2 - 0 V
6 - +	3 - 24 V
7 - OSSD 1	4 - Relay output 1
8 - OSSD 2	5 - Relay output 2
	6 - Input, Relay monitor
	7 - Input, Start release
	8 - Input, Reset
	9 - PNP-output, Soiled optics
	10 - n.c.
	11 - PNP-output, Startup readiness
	12 - PNP-output, Indicator OSSD OFF
	13 - PNP-output, Indicator OSSD ON

Release date: 2012-04-04 14:52 Date of issue: 2012-04-04 11:1842_eng.xml

Technical data**General specifications**

Effective detection range	0.2 ... 10 m
Light source	LED
Light type	modulated visible red light
Approvals	TÜV
Tests	IEC/EN 61496
Safety type according to IEC/EN 61496	4
Marking	CE
Target size	static: 32 mm dynamic: 50 mm (at v = 1.6 m/s of the obstacle)
Beam spacing	500 mm
Number of beams	2
Operating mode	Start/restart disable, relay monitor,
Angle of divergence	< 5 °

Functional safety related parameters

Safety Integrity Level (SIL)	SIL 3
Performance level (PL)	PL e
Category	Cat. 4
Mission Time (T _M)	20 a
PFH _d	3.54 E-9
Type	4

Indicators/operating means

Diagnostics display	7-segment display
Function display	LED red: per receiver channel off: interruption flashes: receiver continuously on: reception with sufficient stability control on the front plate: LED red: OSSD off LED green: OSSD on
Pre-fault indication	LED red next to receiver flashes
Controls	10 DIP switch in receiver terminal compartment

Electrical specifications

Operating voltage	U _B	24 V DC -15% / +25% , galvanically isolated
No-load supply current	I ₀	max. 250 mA
Protection class		III

Input

Activation current	approx. 10 mA
Activation time	0.03 ... 1 s
Test input	Reset-input for system test
Function input	Relay monitor, start release

Output

Output of the pre-fault indication	1 PNP, +U _B -2 V, max. 300 mA
Safety output	2 separated fail safe semiconductor outputs
Signal output	1 PNP each, max. 300 mA for start readiness, OSSD on, OSSD off
Switching voltage	Operating voltage -2 V
Switching current	max. 0.5 A
Response time	20 ms

Ambient conditions

Ambient temperature	0 ... 50 °C (32 ... 122 °F)
Storage temperature	-20 ... 70 °C (-4 ... 158 °F)
Relative humidity	max. 95 %, not condensing

Mechanical specifications

Protection degree	IP65
Connection	M16 cable gland , terminal compartment with cage-terminals, M12-connector for emitter
Connection options	Further electrical connection options on request: Connector DIN 43 651 Hirschmann, emitter: 6-pin+PE, receiver: 11-pin+PE
Material	
Housing	extruded aluminum profile, RAL 1021 (yellow) coated
Optical face	Plastic pane
Mass	Per 2300 g

General information

System components	
Emitter	SLP10-2-T
Receiver	SLPC10-2-R

Curves/Diagrams

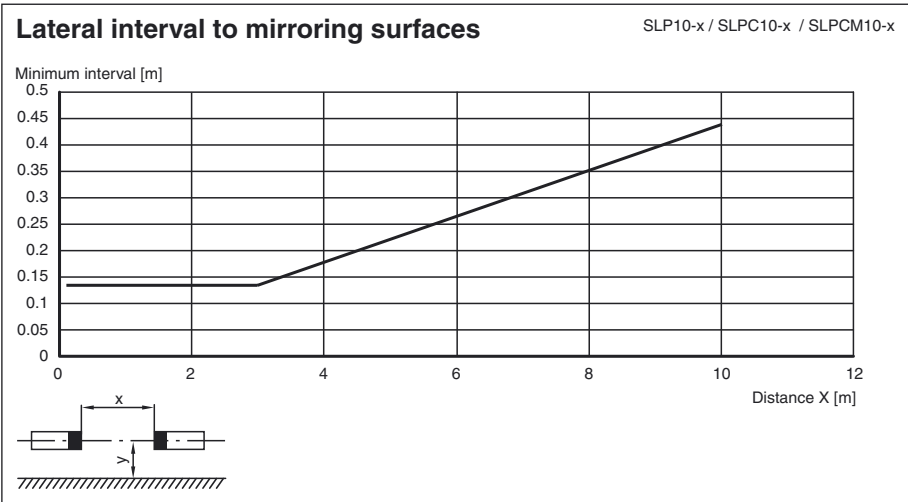
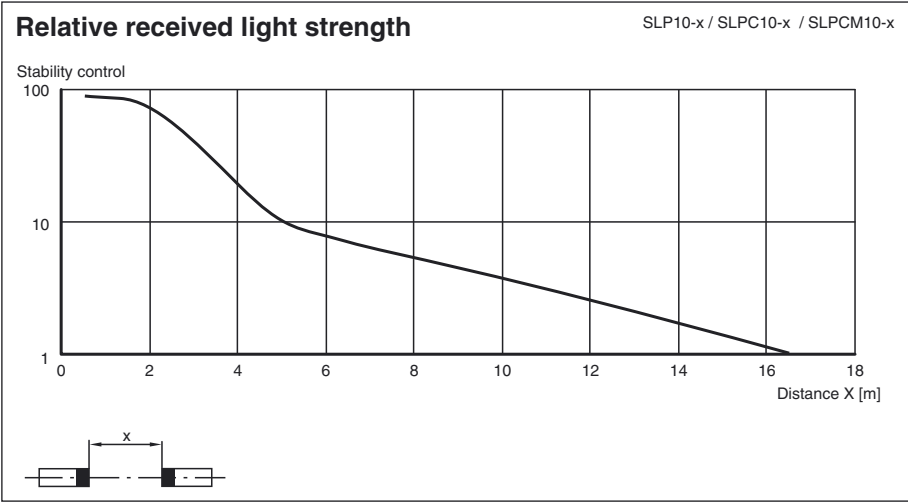
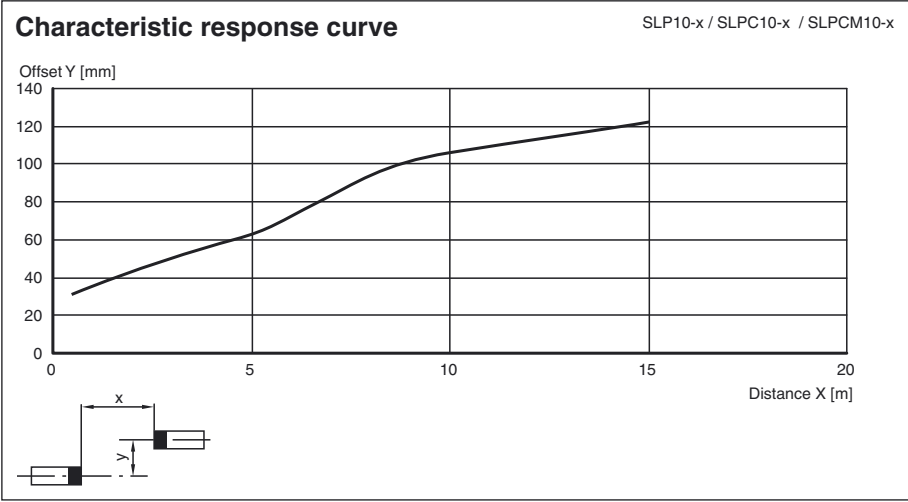

Release date: 2012-04-04 14:52 Date of issue: 2012-04-04 11:1842_eng.xml

Additional information

Socket assignment on the front side of the device

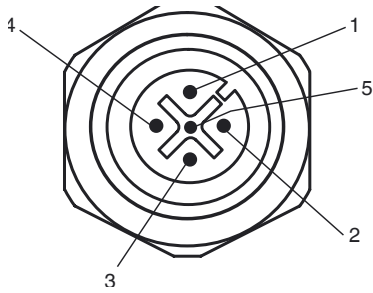

T1 - T4 transmitter control

Socket	Function
1	Transmitter channel 1
2	Transmitter channel 2
3	0 V

System accessories

- Mounting set MS SLP
- Profile alignment aid PA SLP/SLC
- Laser alignment aid BA SLP
- Ground pillar UC SLP/SLC
- Housing for pillar Enclosure UC SLP/SLC
- Collision protector Damping UC SLP/SLC
- Redirection mirror for multi-side protection of hazardous areas SLP-2-M

Release date: 2012-04-04 14:52 Date of issue: 2012-04-04 111842_eng.xml