

**Model Number**

**SLPCM10-4-L/31**

Safety light grid with integrated control unit  
with 2 relay outputs with two force-guided normally open contacts

**Features**

- Detection range up to 10 m
- 4-Radial design
- Beam spacing 300 mm
- Self-monitoring (type 4 according to IEC/EN 61496-1)
- Red transmission light
- Usable with or without start/restart disable
- Sequential and parallel muting in various operating modes
- Emergency muting for the correction of the material jam
- Integrated relay monitor
- 7-segment diagnostic display
- Integrated function display
- Pre-fault indication
- OSSD outputs as semiconductor or relay outputs

**Accessories**

**PG SLP-4**  
Mounting aid Safety

**Dimensions**

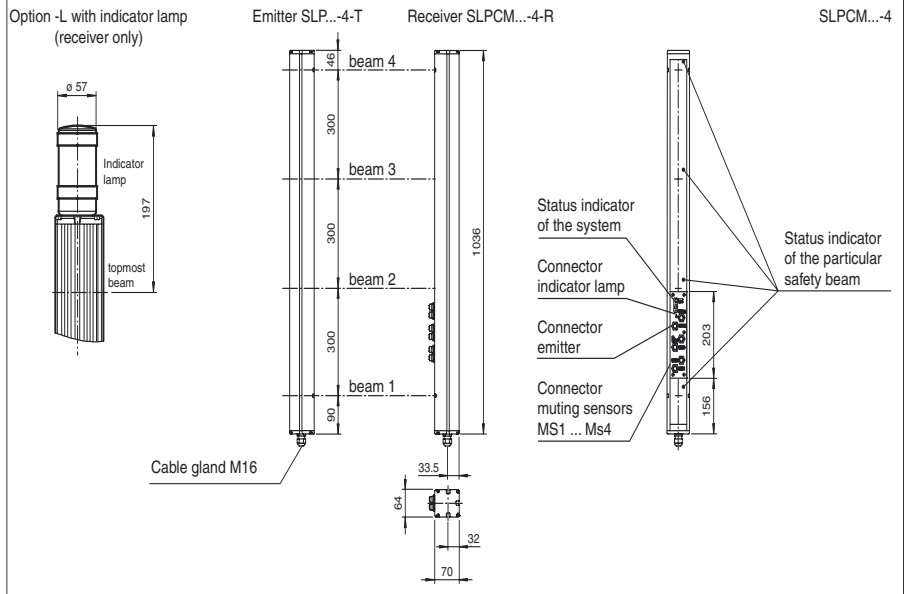

**Electrical connection**

Emitter SLP

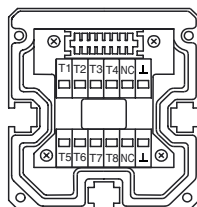

- T1 - Emitter channel 1
- T2 - Emitter channel 2
- T3 - Emitter channel 3
- T4 - Emitter channel 4
- ⊥ - 0V

Receiver SLPCM

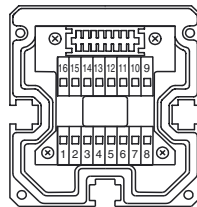

Receiver SLPCM (semiconductor outputs)	Receiver SLPCM/31 (Relay outputs)
4 - n.c.	1 - Functional earth
5 - -	2 - 0V
6 - +	3 - 24V
7 - OSSD 1	4 - Relay monitor
8 - OSSD 2	5 - Start release
	6 - Reset
	7 - PNP-output, Soiled optics
	8 - PNP-output, Muting lamp
	9 - PNP-output, Startup readiness
	10 - PNP-output, Indicator OSSD OFF
	11 - PNP-output, Indicator OSSD ON

Release date: 2009-12-14 11:22 Date of issue: 2009-12-14 11:4868\_ENG.xml

**Technical data****General specifications**

Effective detection range	0.2 ... 10 m
Light source	LED
Light type	red, modulated light
Approvals	TÜV
Tests	IEC/EN 61496
Safety type according to IEC/EN 61496	4
Marking	CE
Obstacle size	static: 32 mm dynamic: 50 mm (at v = 1.6 m/s of the obstacle)
Beam spacing	300 mm
Number of beams	4
Operating mode	Start/restart disable, relay monitor, muting operating modes
Angle of divergence	< 5 °

**Functional safety related parameters**

Safety Integrity Level (SIL)	SIL 3
Performance level (PL)	PL e
Category	Cat. 4
Mission Time (T <sub>M</sub> )	20 a
PFH <sub>d</sub>	3.54 E-9

**Indicators/operating means**

Diagnosis display	7-segment display
Function display	LED red: per receiver channel off: interruption flashes: receiver continuously on: reception with sufficient stability control on the front plate: LED red: OSSD off LED green: OSSD on LED yellow: types of muting operation
Muting display	Indicator lamp
Pre-fault indication	LED red next to receiver flashes
Operating elements	10 DIP switch in receiver terminal compartment

**Electrical specifications**

Operating voltage	U <sub>B</sub>	24 V DC -15 % / +25 %, electrically isolated
No-load supply current	I <sub>0</sub>	max. 250 mA
Protection class		III

**Input**

Activation current	approx. 10 mA
Activation time	0.03 ... 1 s
Test input	Reset-input for system test
Function input	Relay monitor, start release, muting sensors (max. 4)

**Output**

Output of the pre-fault indication	1 PNP, +U <sub>B</sub> -2 V, max. 300 mA
Safety output	2 relay outputs, compelled connection NO-contact
Signal output	1 PNP each, max. 300 mA for startup readiness, OSSD on, OSSD off, muting lamp, signals in parallel in the lamp socket
Switching voltage	20 ... 60 V DC, 12 ... 25 V AC <sub>rms</sub>
Switching current	0.01 ... 2 A
Switch power	100 VA
Response time	40 ms

**Ambient conditions**

Ambient temperature	0 ... 50 °C (273 ... 323 K)
Storage temperature	-20 ... 70 °C (253 ... 343 K)
Relative humidity	max. 95 %, not condensing

**Mechanical specifications**

Protection degree	IP65
Connection	Cable screwed connection M16 , terminal compartment with cage terminals, M12 connector for transmitters, muting lamp, etc., muting sensors, lamp socket for muting lamp, etc.
Connection options	Further electrical connection options on request: Connector DIN 43 651 Hirschmann, emitter: 6-pin+PE, receiver: 11-pin+PE
Material	
Housing	aluminium extruded structural profile, RAL 1021 (yellow) coated
Optical face	Plastic pane
Mass	Per 3700 g

**General information**

System components	
Emitter	SLP10-4-T
Receiver	SLPCM10-4-R-L/31

Curves/Diagrams

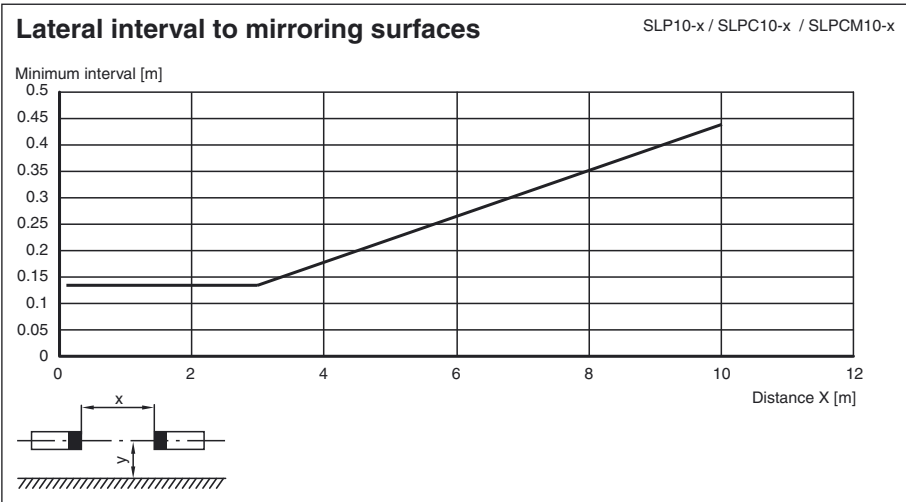
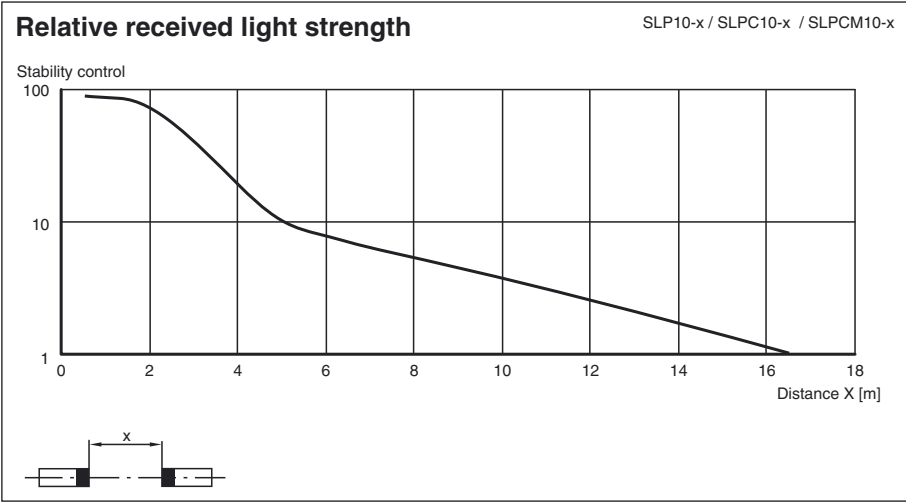
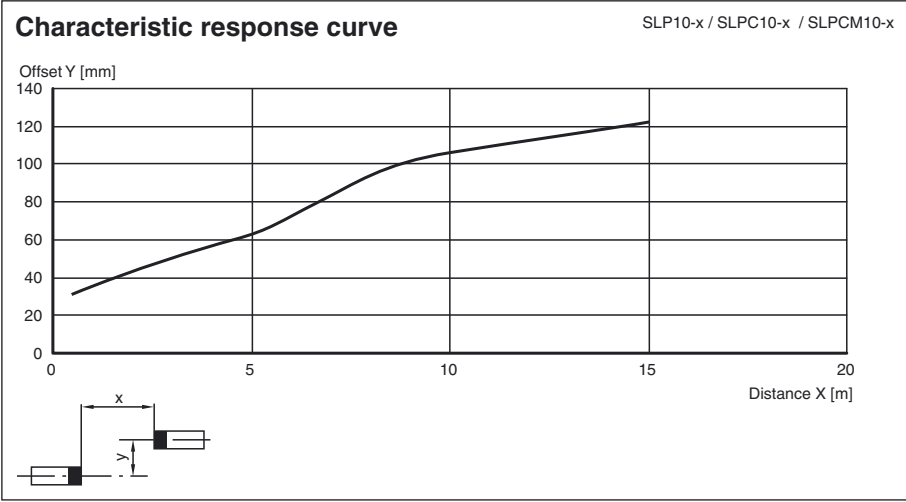

Release date: 2009-12-14 11:22 Date of issue: 2009-12-14 11:4868\_ENG.xml

**Additional information**

**Socket assignment on the front side of the device**

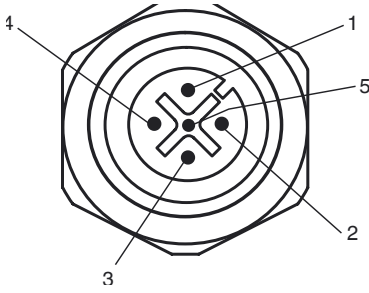

Indicator lamp control

Socket	Function
1	OSSD on
2	OSSD off
3	0 V
4	Readiness for startup
5	Muting (monitored)

**T1 - T4 transmitter control**

Socket	Function
1	Transmitter channel 1
2	Transmitter channel 2
3	0 V
4	Transmitter channel 3
5	Transmitter channel 4

**Muting sensor inputs MS1 - MS4**

Socket	Function
1	+ 24 V
3	0 V
4	Sensor signal

**System accessories**

- Mounting set MS SLC
- Profile alignment aid PA SLP/SLC
- Laser alignment aid BA SLP
- Ground pillar UC SLP/SLC
- Housing for pillar Enclosure UC SLP/SLC
- Collision protector Damping UC SLP/SLC
- Redirection mirror SLP-4-M