



Model Number

V11-W-10M-PVC

Female cordset, M12, 3-pin, PVC cable

Features

- Knurled nut suitable for tool assembly
- Immunity to vibration, with mechanical latching
- Gold plated contacts
- Degree of protection IP67 / IP68 / IP69K

Dimensions

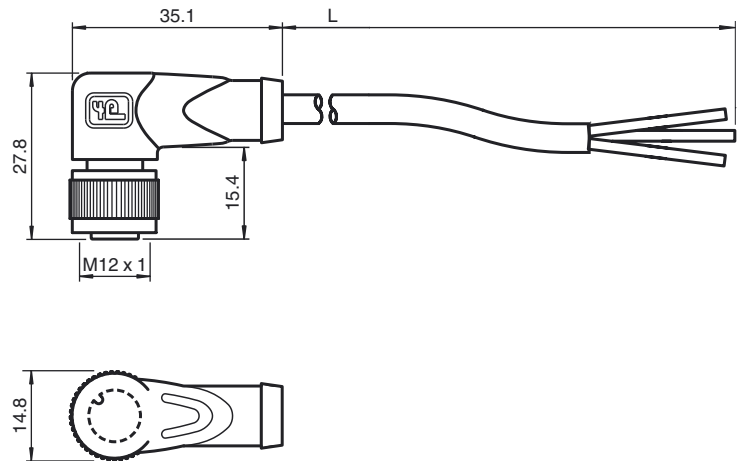

Technical data

General specifications

Number of pins	3
Connection 1	socket
Construction type 1	right angle
Threading 1	M12
Connection 2	cable end

Electrical specifications

Operating voltage	U_B	max. 250 V AC/DC
Operating current		max. 4 A
Contact resistance		< 10 mΩ

Ambient conditions

Ambient temperature	-25 ... 100 °C (-13 ... 212 °F)
	For temperatures over 80 °C (176 °F) reduced elongation at rupture
Pollution Degree	3

Mechanical specifications

Contact elements	spring-loaded contact socket	
Pin diameter	1 mm	
Degree of protection	IP67 / IP68 / IP69k	
Material		
Contacts	CuSn / Au	
Contact surface	Au	
Body	TPU, black	
Cable	PVC	
Slotted nut	Diecast zinc	
Core insulation	PVC	
Cable	fine-strand, flexible	
Sheath diameter	Ø 4.8 mm	
Bending radius	> 10 x cable diameter, moving	
Color	grey	
Cores	3 x 0.34 mm ²	
Conductor construction	19 x 0.15 mm Ø	
Length	L	10 m
Flammability		
Contact material	94 HB	
Housing	94 V-2	

Compliance with standards and directives

Standard conformity	
Degree of protection	EN 60529:2000
Standards	IEC 61076-2-101:2008
Flammability	Grip: UL 94

Electrical connection

