

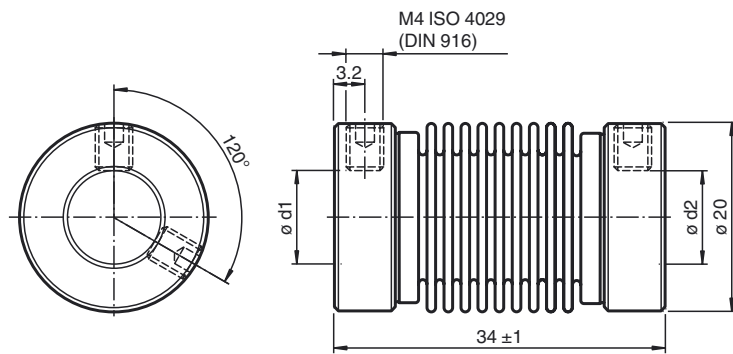

## Dimensions



## Model Number

**9460 6\*6**

Stainless steel bellows coupling

## Features

- Backlash-free, angle synchronous rotation transmission
- Optimal misalignment compensation
- Very high torsion spring stiffness
- Small reset forces
- Vibration- isolating
- Bellows and screws made of stainless steel

## Technical data

### Ambient conditions

Operating temperature	-30 ... 120 °C (-22 ... 248 °F)
-----------------------	---------------------------------

### Mechanical specifications

Shaft diameter	d1 = 6 mm , d2 = 6 mm
Material	Stainless steel 1.4305 / AISI 303
Mass	30.1 g
Rotational speed	max. 10000 min
Max. torque	0.8 Nm
Radial offset	max. ± 0.3 mm
Axial offset	max. ± 0.5 mm
Angle error	max. ± 4 °
Torsion spring stiffness	140 Nm / rad
Radial spring stiffness	10 N / mm
Moment of inertia	18.81 kg m <sup>2</sup> x 10 <sup>-7</sup>
Mounting	clamp screws , M4 DIN 916
Tightening torque of clamping screws	max. 0.15 Nm