

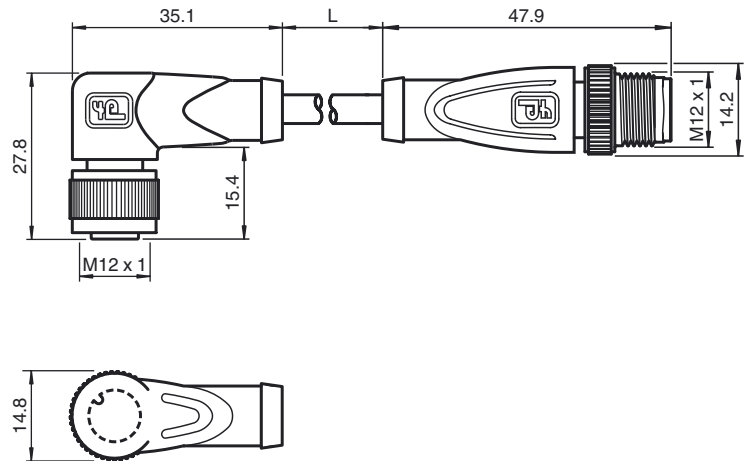

**Dimensions**



**Model Number**

**V1-W-3M-PUR-H/S-V1-G**

Connecting cable, M12, 4-pin, irradiated PUR cable

**Features**

- Knurled nut suitable for tool assembly
- Immunity to vibration, with mechanical latching
- Gold-plated and machined contacts
- Protection degree IP67 / IP68 / IP69K
- Halogen-free
- Flexible sheathing

**Technical data**

**General specifications**

Number of pins	4
Connection 1	socket
Construction type 1	right angle
Threading 1	M12
Connection 2	Male connector
Construction type 2	straight
Threading 2	M12

**Electrical specifications**

Operating voltage	U <sub>B</sub>	max. 300 V DC max. 250 V AC
Operating current		max. 4 A
Contact resistance		< 10 mΩ

**Ambient conditions**

Ambient temperature	40 ... 90 °C (104 ... 194 °F) cable, fixed: -50 ... 105 °C (-58 ... 221 °F) cable, flexing: -40 ... 105 °C (-40 ... 221 °F)
Pollution Degree	3

**Mechanical specifications**

Contact elements	spring-loaded contact socket
Pin diameter	1 mm
Protection degree	IP67 / IP68 / IP69K
<b>Material</b>	
Contacts	CuSn / Au
Contact surface	Au
Body	TPU, black
Cable	PUR, irradiated
Slotted nut	Diecast zinc
Sleeve connector	Diecast zinc
Core insulation	TPE-E
<b>Cable</b>	fine-strand, flexible
Sheath diameter	Ø 4.8 mm
Bending radius	> 10 x cable diameter, moving > 5 x cable diameter, single bend
Color	orange
Cores	4 x 0.34 mm <sup>2</sup>
Conductor construction	19 x 0.15 mm Ø
Length	L 3 m
<b>Flammability</b>	
Contact material	94 HB
Housing	94 V-2

**Compliance with standards and directives**

Standard conformity	
---------------------	--

**Electrical connection**

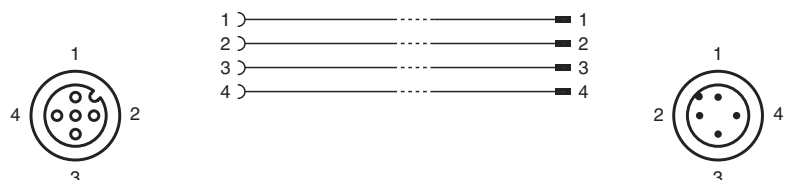

Release date: 2013-08-23 13:19 Date of issue: 2013-08-23 124242\_eng.xml



Protection degree	EN 60529:2000
Standards	IEC 61076-2-101:2008
Flammability	Grip: UL 94

Release date: 2013-06-23 13:19 Date of issue: 2013-06-23 124242\_eng.xml