

Dimensions

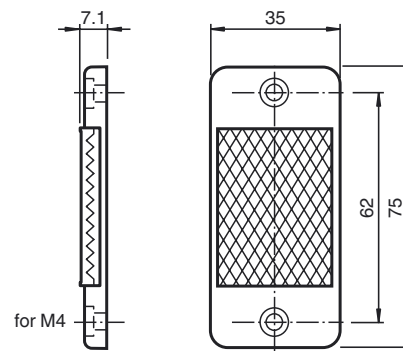

Model Number

REF-H75

Reflector, rectangular 75 mm x 35 mm,
mounting holes

Features

- Mounting holes for simple installation

Technical data

General specifications

Construction type rectangular

Ambient conditions

Ambient temperature -20 ... 60 °C (-4 ... 140 °F)

Mechanical specifications

Material PMMA/ABS

Dimensions 75 mm x 35 mm x 7.1 mm

Mounting mounting holes