



Model Number

ML4.2-8-H-60-IR/40b/95/110

Background suppression sensor with 4-pin, M8 x 1 connector

Features

- Precise background suppression
- Very small black-white difference
- Small, sharp light spot
- Highly visible LEDs for Power-On, switching status, short-circuit, and undervoltage
- Metal-reinforced fastening holes
- Tamper-proof version with no adjustments
- Push-pull output

Product information

The ML4.2 series is characterized by a robust, powerful and standard design in a miniature housing. The housing offers IP67/ IP69K degree of protection, a scratch- and chemical-resistant lens, highly visible LEDs and robust all-metal bushings for mounting. Adjustable and tamper-proof sensors are available with a universal push-pull output and an electrical light ON/dark ON switch. The sensors have a high ambient light limit. Reflections from the background are suppressed. The unusually small, sharp light spot and the quick response time offer maximum switching precision on object edges.. Both red and infrared light sources are available. A high-performance fixed focus background suppressor is a useful feature. The sensors are suitable for precise object detection and open up a wide range of application fields.

Release date: 2013-05-07 10:23 Date of issue: 2013-05-16 18:452_eng.xml

Dimensions

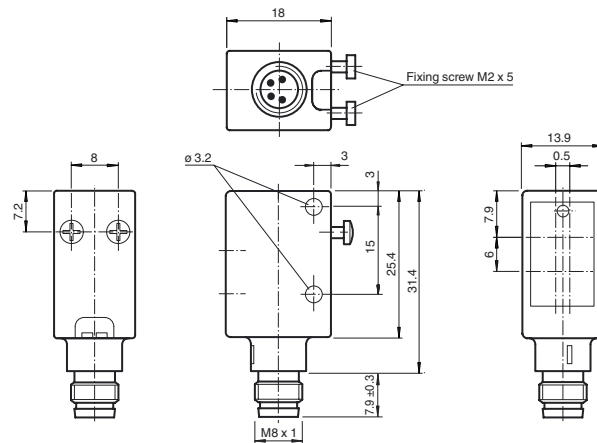

Electrical connection

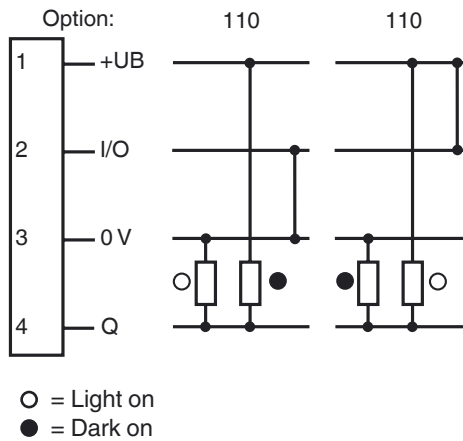

Pinout



Indicators/operating means

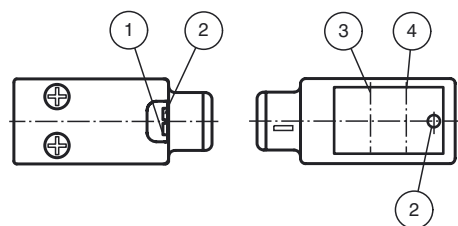

1	operating display	green
2	indication of the switching state	yellow
3	receiver axis	
4	emitter axis	

Technical data**General specifications**

Detection range	10 ... 60 mm
Detection range max.	10 ... 80 mm
Background suppression	starts from 80 mm
Light source	IRED
Light type	modulated infrared light , 880 nm
Black/White difference (6 %/90 %)	approx. 10 mm
Diameter of the light spot	approx. 4 mm at 60 mm
Angle of divergence	approx. 5 °
Ambient light limit	
Continuous light	40000 Lux
Modulated light	5000 Lux

Functional safety related parameters

MTTF _d	1940 a
Mission Time (T _M)	20 a
Diagnostic Coverage (DC)	0 %

Indicators/operating means

Operating display	LED green, statically lit Power on , Undervoltage indicator: Green LED, pulsing (approx. 0.8 Hz) , short-circuit : LED green flashing (approx. 4 Hz)
Function display	LED yellow: lights when object is detected

Electrical specifications

Operating voltage	U _B	10 ... 30 V DC
Ripple		10 %
No-load supply current	I ₀	< 25 mA

Output

Switching type	light/dark on electrically switchable	
Signal output	Push-pull output, short-circuit protected, reverse polarity protected	
Switching voltage	max. 30 V DC	
Switching current	max. 100 mA	
Voltage drop	U _d	≤ 2.5 V DC
Switching frequency	f	1000 Hz
Response time		0.5 ms

Ambient conditions

Ambient temperature	-20 ... 60 °C (-4 ... 140 °F)
Storage temperature	-20 ... 75 °C (-4 ... 167 °F)

Mechanical specifications

Protection degree	IP67 / IP69K
Connection	M8 x 1 connector, 4-pin
Material	
Housing	ABS
Optical face	glass pane
Mass	approx. 10 g

Compliance with standards and directives

Standard conformity	
Product standard	EN 60947-5-2:2007 IEC 60947-5-2:2007
Shock and impact resistance	IEC / EN 60068. half-sine, 40 g in each X, Y and Z directions
Vibration resistance	IEC / EN 60068-2-6. Sinus. 10 -150 Hz, 5 g in each X, Y and Z directions

Approvals and certificates

CE conformity	yes
UL approval	cULus Listed
CCC approval	CCC approval / marking not required for products rated ≤36 V

Accessories**OMH-4.1**

Mounting Clamp

OMH-ML6

Mounting bracket

OMH-ML6-U

Mounting bracket

OMH-ML6-Z

Mounting bracket

V31-GM-2M-PVC

M8, 4-pin socket, PVC cable

V31-WM-2M-PVC

M8, 4-pin socket, PVC cable

Other suitable accessories can be found at www.pepperl-fuchs.com

Curves/Diagrams

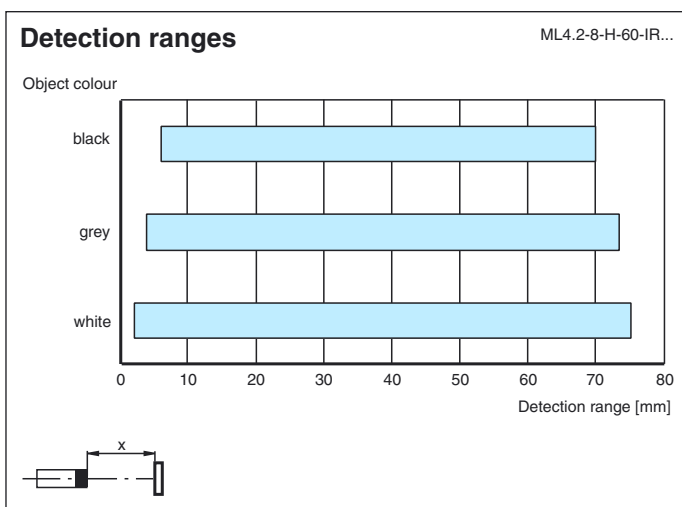
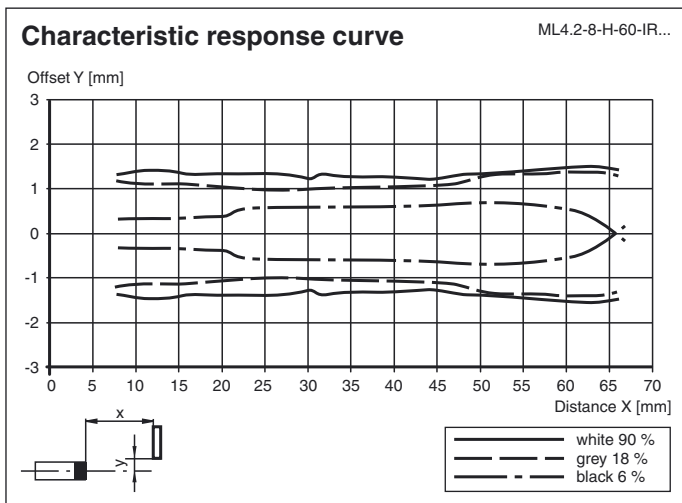

Release date: 2013-05-07 10:23 Date of issue: 2013-05-16 189452_eng.xml

Refer to "General Notes Relating to Pepperl+Fuchs Product Information".

Pepperl+Fuchs Group
www.pepperl-fuchs.com

USA: +1 330 486 0001
fa-info@us.pepperl-fuchs.com

Germany: +49 621 776 4411
fa-info@de.pepperl-fuchs.com

Singapore: +65 6779 9091
fa-info@sg.pepperl-fuchs.com