

Dimensions

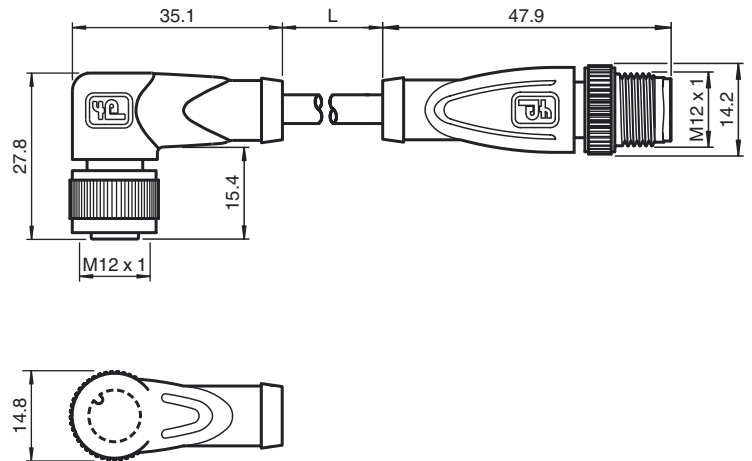

Model Number

V11-W-3M-PUR-V11-G
 Connecting cable, M12 to M12, PUR cable 3-pin

Features

- Knurled nut suitable for tool assembly
- Immunity to vibration, with mechanical latching
- Gold-plated and machined contacts
- Degree of protection IP67 / IP68 / IP69K
- Halogen-free
- Suitable for 2- and 3-wire technology

Technical data

General specifications

Number of pins	3
Connection 1	socket
Construction type 1	right angle
Threading 1	M12
Connection 2	Male connector
Construction type 2	straight
Threading 2	M12

Electrical specifications

Operating voltage	U_B	max. 300 V DC
Test voltage		> 1500 V _{eff} AC
Operating current		max. 4 A
Volume resistance		< 5 mΩ

Ambient conditions

Ambient temperature	-25 ... 100 °C (-13 ... 212 °F) for temperatures over 80 °C (176 °F) reduced elongation at tear
Pollution Degree	3

Mechanical specifications

Contact elements	spring-loaded contact socket	
Pin diameter	1 mm	
Degree of protection	IP67 / IP68 / IP69k	
Material		
Contacts	CuSn / Au	
Contact surface	Au	
Body	TPU, green	
Cable	PUR	
Slotted nut	Diecast zinc	
Sleeve connector	Diecast zinc	
Core insulation	PP	
Cable	fine-strand, flexible	
Sheath diameter	Ø4.8 mm	
Bending radius	> 10 x cable diameter, moving	
Color	grey	
Cores	3 x 0.34 mm ²	
Conductor construction	19 x 0.15 mm Ø	
Length	L	3 m
Flammability		
Contact material	94 V-2	
Housing	94 V-2	

Electrical connection



Release date: 2014-03-25 14:41 Date of issue: 2014-03-25 187923_eng.xml

Refer to "General Notes Relating to Pepperl+Fuchs Product Information".

Pepperl+Fuchs Group
 www.pepperl-fuchs.com

USA: +1 330 486 0001
 fa-info@us.pepperl-fuchs.com

Germany: +49 621 776 4411
 fa-info@de.pepperl-fuchs.com

Singapore: +65 6779 9091
 fa-info@sg.pepperl-fuchs.com