



**Model Number**

**GLV18-8-450/25/102/159**

Diffuse mode sensor  
with 3-pin, M12 x 1 plastic connector

**Features**

- Efficient Line in a short M18 plastic housing for standard applications
- Very high detection range
- 4 LEDs indicator for 360° visibility
- Optimized potentiometer design for a clear control button layout in the application
- Version with front optical face
- DC voltage version

**Product information**

The GLV/GLK18 series sensors help improve the efficiency of machines and systems. The design of the M18 plastic housing, the connection technology, and sensor properties are highly standardized. Concentrating on the key sensor requirements has produced a robust and reliable product series for DC and AC/DC voltage systems without any over-engineering. The mounting set included in the scope of delivery and the optimized potentiometer design ensure fast assembly and easy configuration.

Release date: 2012-12-17 08:01 Date of issue: 2013-01-09 188563\_eng.xml

**Dimensions**

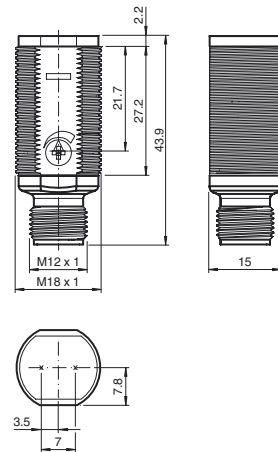

**Electrical connection**

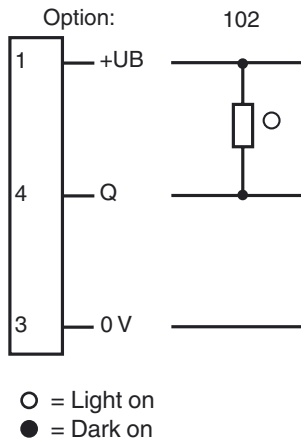

**Pinout**

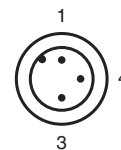

**Indicators/operating means**

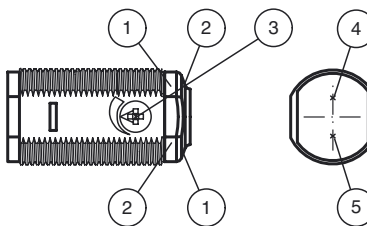

1	Operating display	green
2	Signal display	yellow
3	Sensitivity adjustment	
4	Emitter	
5	Receiver	

**Technical data****General specifications**

Detection range	50 ... 450 mm adjustable
Detection range max.	0 ... 450 mm
Reference target	100 mm x 100 mm Kodak white
Light source	LED
Light type	modulated visible red light , 640 nm
Diameter of the light spot	approx. 30 mm at 400 mm
Angle of divergence	approx. 4 °
Optical face	frontal
Ambient light limit	30000 Lux
Hysteresis	H < 15 %

**Functional safety related parameters**

MTTF <sub>d</sub>	920 a
Mission Time (T <sub>M</sub> )	20 a
Diagnostic Coverage (DC)	0 %

**Indicators/operating means**

Operating display	LED green, statically lit Power on
Function display	LED yellow: lights when object is detected ; flashes when falling short of the stability control
Controls	sensitivity adjustment

**Electrical specifications**

Operating voltage	U <sub>B</sub>	10 ... 30 V DC
No-load supply current	I <sub>0</sub>	< 20 mA

**Output**

Switching type	light on	
Signal output	1 NPN, short-circuit protected open collector	
Switching voltage	max. 30 V DC	
Switching current	max. 100 mA	
Voltage drop	U <sub>d</sub>	≤ 1.5 V DC
Switching frequency	f	500 Hz
Response time		≤ 1 ms

**Ambient conditions**

Ambient temperature	-25 ... 60 °C (-13 ... 140 °F)
Storage temperature	-40 ... 70 °C (-40 ... 158 °F)

**Mechanical specifications**

Protection degree	IP67
Connection	Connector M12 x 1, 3-pin
Material	
Housing	PC
Optical face	PMMA
Connector	plastic
Mass	approx. 10 g

**Compliance with standards and directives**

Standard conformity	
Product standard	EN 60947-5-2:2007 IEC 60947-5-2:2007

**Approvals and certificates**

Protection class	II, rated insulation voltage ≤ 250 V AC with pollution degree 1-2 according to IEC 60664-1
UL approval	cULus Listed, Class 2 Power Source
CCC approval	Products with a maximum operating voltage of ≤36 V do not bear a CCC marking because they do not require approval.

**Accessories****CPZ18B03**

Mounting Bracket with swivel nut

**BF 18**

Mounting flange, 18 mm

**BF 18-F**

Mounting flange with dead stop, 18 mm

**BF 5-30**

Universal mounting bracket for cylindrical sensors with a diameter of 5 ... 30 mm

**V11-G-2M-PUR**

Cable socket, M12, 3-pin, PUR cable

**V11-W-2M-PUR**

Cable socket, M12, 3-pin, PUR cable

Other suitable accessories can be found at [www.pepperl-fuchs.com](http://www.pepperl-fuchs.com)

**Curves/Diagrams**

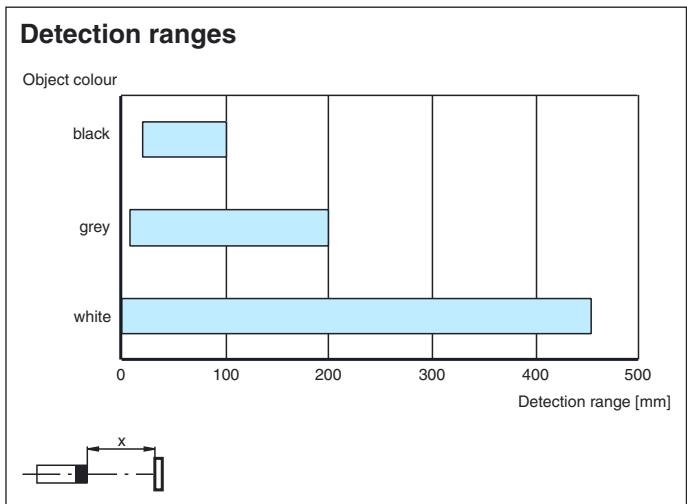
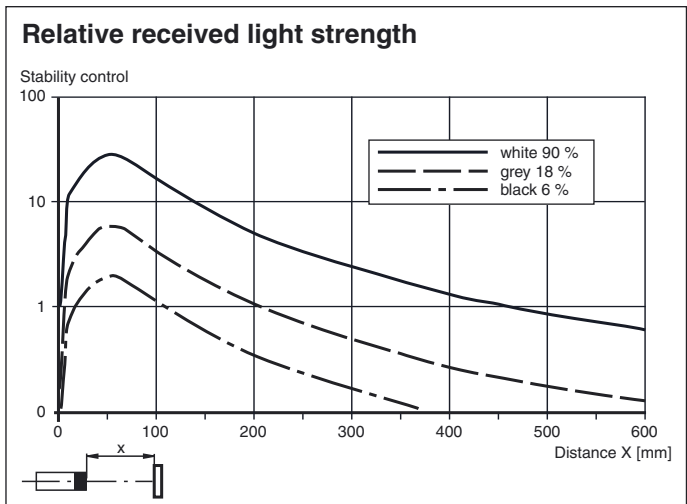
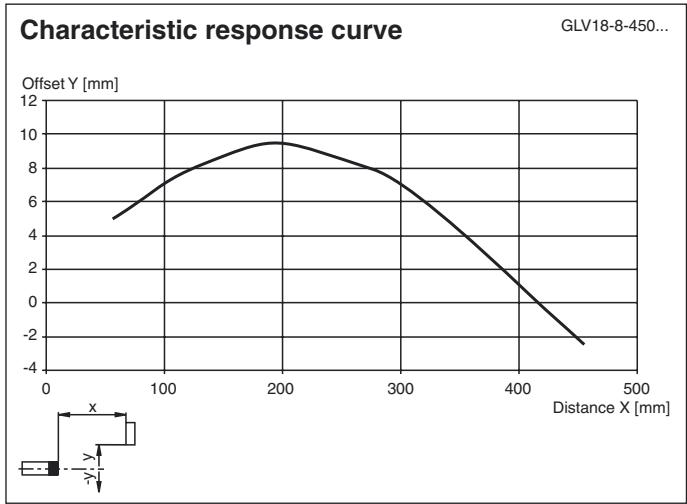

Release date: 2012-12-17 08:01 Date of issue: 2013-01-09 188563\_eng.xml