

Model Number

SB4 Housing 4

Empty housing for Evaluation unit SB4

Features

- Housing of the SafeBox with back-plane for completion

Dimensions

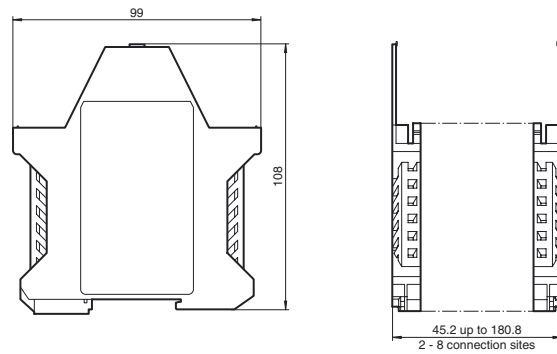

Technical data

General specifications

Approvals TÜV, cULus

Mechanical specifications

Material Polyamide (PA)

Model number

Number of plug-in stations	Description	Housing width (mm)
2	SB4 Housing 2	45.2
3	SB4 Housing 3	67.8
4	SB4 Housing 4	90.4
5	SB4 Housing 5	113.0
6	SB4 Housing 6	135.6
7	SB4 Housing 7	158.2
8	SB4 Housing 8	180.8

Release date: 2007-07-31 13:08 Date of issue: 2011-02-23 190771_ENG.xml

Subject to modifications without notice

Pepperl+Fuchs Group
www.pepperl-fuchs.com

USA: +1 330 486 0001
fa-info@us.pepperl-fuchs.com

Germany: +49 621 776-4411
fa-info@pepperl-fuchs.com

Copyright Pepperl+Fuchs
Singapore: +65 6779 9091
fa-info@sg.pepperl-fuchs.com