



Model Number

TopScan-S-M3S/L900

Active infrared scanner
Profile length 900 mm

Features

- Moving presence sensor for swing doors
- Configurable for a wide range of door leaf widths
- Category 2, tested and certified to DIN 18650/EN 16005
- Modular construction with master/slave modules
- Safe function even on difficult floors
- Each beam can be adjusted individually
- Easy adjustment of transmitter for hinge side/ opposite hinge side
- Four-beam version

Product information

The TopScan-S is a presence sensor for automatic revolving doors that operates according to the active infrared principle in background evaluation, and can be installed for mobile use in addition to static use. The modular structure consisting of master and slave modules means that the systems can be configured for different door panel widths up to 1400 mm. Up to 7 individually adjustable beams can be used in one device. This ensures test object detection across the entire door width. The sensors are certified according to the current DIN 18650/EN 16005 standard and, in conjunction with an appropriate, safe controller, fulfill all requirements for testable active opto-electronic protective devices (AOPDs) in Category 2.

Dimensions

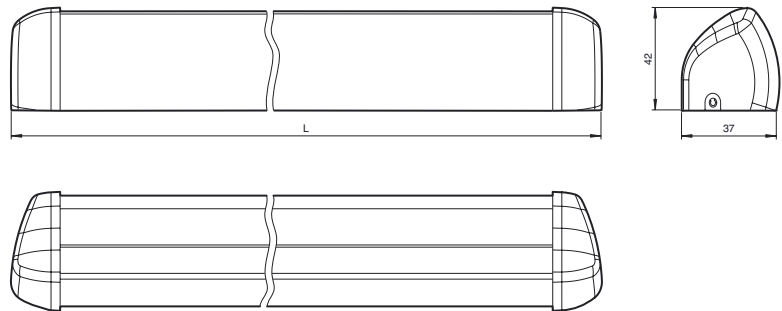

Electrical connection

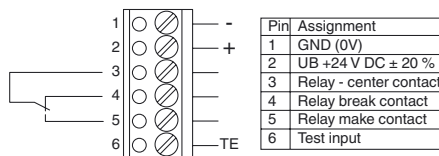

Explanation:
Relay:
Relay is inactive during detection
Relay is active in free detection field

Test input:
Test input is inactive at: U_{low} = -3 V ... +5 V DC
Test input is active at: U_{high} = +11 V ... +30 V DC

Indicators/operating means

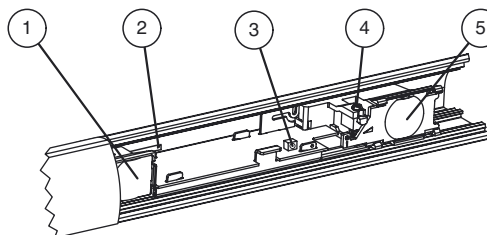

1	Emitter
2	Changeover switch adjuster, left/right
3	Function display
4	Detection range adjuster
5	Receiver

Technical data**General specifications**

Detection range min.	0 ... 1500 mm
Detection range max.	0 ... 2500 mm
Reference target	Minimum degree of reflection of the floor: 6 % Minimum degree of reflection to objects being detected: 0 %
Light source	IREd
Light type	modulated infrared light 875 nm
Black/White difference (6%/90%)	< 2 % at 2000 mm sensor range
Number of beams	4 (number of built-in sensor modules AIR)
Operating mode	Background evaluation
Diameter of the light spot	1.1 cm x 8.3 cm at 2000 mm sensor range
Resolution	Reference object CA DIN 186850-1/EN 16005 in all applicable locations

Functional safety related parameters

Safety Integrity Level (SIL)	SIL 1
Performance level (PL)	PL c
Category	Cat. 2
MTTF _d	880 a per module
Mission Time (T _M)	20 a
Diagnostic Coverage (DC)	90 %

Indicators/operating means

Function indicator	LED red/green
Control elements	Detection range adjuster ; Adjuster for edge monitoring left/right

Electrical specifications

Operating voltage	U _B	24 V DC +/- 20 %
No-load supply current	I ₀	270 mA

Input

Test input	active at U = 11 V DC at 30 V DC inactive at U = -3 V DC at 5 V DC
------------	--

Output

Switching type	Relay de-energized at object inside the scanning range
Signal output	Relay, 1 alternator
Switching voltage	5 V ... 30 V AC/DC
Switching current	max. 300 mA
Response time	≤ 70 ms

Ambient conditions

Ambient temperature	-10 ... 50 °C (14 ... 122 °F)
Relative humidity	Humidity at 20 °C: < 90 % Humidity at 60 °C: < 50 %

Mechanical specifications

Housing length L	900 mm
Mounting height	max. 2500 mm
Degree of protection	IP52 , IP54 Optional (with special seal)
Connection	screw terminals ; Cable cross-section 0.3 mm ² ... 1.3 mm ² (AWG26-16), single-stranded/multistranded CU
Material	
Housing	aluminum / ABS
Optical face	PMMA
Note	Safety fuse ≤ 1 A (slow-blow) according to IEC 60127-2 Sheet 1 Recommendation: after a short circuit, check that the device is functioning correctly.

Compliance with standards and directives

Directive conformity	
Machinery Directive 2006/42/EC	EN 12978:2003+A1:2009 EN ISO 13849-1:2008 + AC:2009 EN 16005:2012 Chapter 4.6.8
EMC Directive 2004/108/EC	EN 61000-6-2:2005; EN 61000-6-3:2007
Standard conformity	
Standards	EN 61508-1:2010 DIN 18650-1:2010 Chapter 5.7.4 EN 62471:2009-03

Approvals and certificates

CCC approval	CCC approval / marking not required for products rated ≤36 V
TÜV approval	TÜV NORD

Operating principle

The TopScan-S is an active infrared triangulation sensor.

The device operates according to the active infrared principle in background evaluation mode, and is designed for installation on door panels for mobile use, in addition to static use. This makes the TopScan-S ideal for protection of closing edges on automatic revolving door panels. A sensor mounted directly on the door panel of a revolving door provides the best protection possible, as it always monitors the immediate vicinity in front of the current door panel position.

Typical applications

- Protection mechanism for closing edges on automatic doors
- Anti-collision protection for people/objects in the vicinity of revolving or carousel doors.

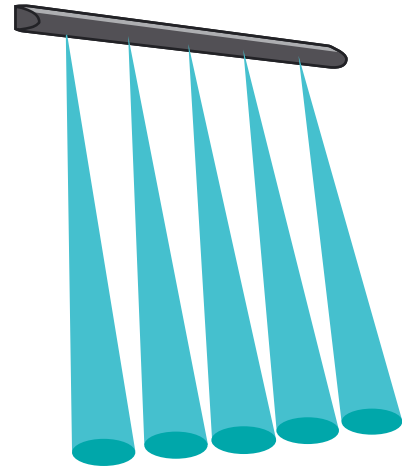
Detection area**Accessories****DoorScan Weather Cap L1200**

All-weather hood for DoorScan® and TopScan series sensing strips

AIR17-S Master

Replacement/extension sensor module

AIR17-S Slave

Replacement/extension sensor module

TopScan-S Profile L1400

Housing profile TopScan-S

TopScan-S Cover L1400

Housing cover TopScan-S

TopScan-S Cap Set

End cover for TopScan-S aluminum profile section

TopScan-S Gasket IP54

Housing seal TopScan-S

AIR 16 S Einclipsbar Set

Bearing block for AIR17-S sensor module for installation in TopScan-S profile section

TopScan-S Cable Loop Basic

Metal cable protector

TopScan-S Test Kit

Adjustment accessories TopScan-S

TopScan-S Cable 240 mm

Ribbon cable for connecting sensor modules

Other suitable accessories can be found at www.pepperl-fuchs.com

Construction

The TopScan-S consists of an aluminum profile with front panel, and can be adapted to different door widths up to 1400 mm as required. The profile is equipped with sensor modules and constructed according to the master/slave principle. A 900 mm door would require a master and three slaves for example, while a 7-beam system with master and six slaves represents the maximum version for a 1400 mm door. Within the housing, there are multiple sensors that must be positioned according to specific application requirements.

DIN

The TopScan-S is intended for providing protection for automatic revolving doors according to DIN 18650 / EN 16005. When used as intended, the sensor should only be able to influence the movement of the door via the door controller rather than directly, as the combination of a safe door controller and a sensor is a prerequisite for the system to be considered a protective device according to EN ISO 13849-1, Performance Level "c" Category 2.



Modification of the construction/arrangement of the equipment without consulting the manufacturer could lead to hazardous situations.

Objects that enter the sensor's protection area are detected by infrared beams and cause the relay contact output to become disabled. The light spot created on the floor by the infrared beam is approx. 1,1 cm x 8,3 cm large (at approx. 2 m installation height). The angle of the two lens systems can be changed by means of adjustment. This allows a detection range (detection height of objects) of up to 2.50 m max. to be set. The device is equipped with test objects for setting the detection range. The sensor reacts to objects in the detection range, largely irrespective of surface color and structure. Even reflective and extremely dark objects are detected. Multiple sensors can be operated in a master/slave combination, in order to adapt the protection field to existing requirements. A 6-pin screw terminal is used to connect the master module with the door controller. The slave modules are connected to the master module by means of ribbon cable, and are also powered via the master module. The master module and slave module are located in the same aluminum profile.

Design of the device

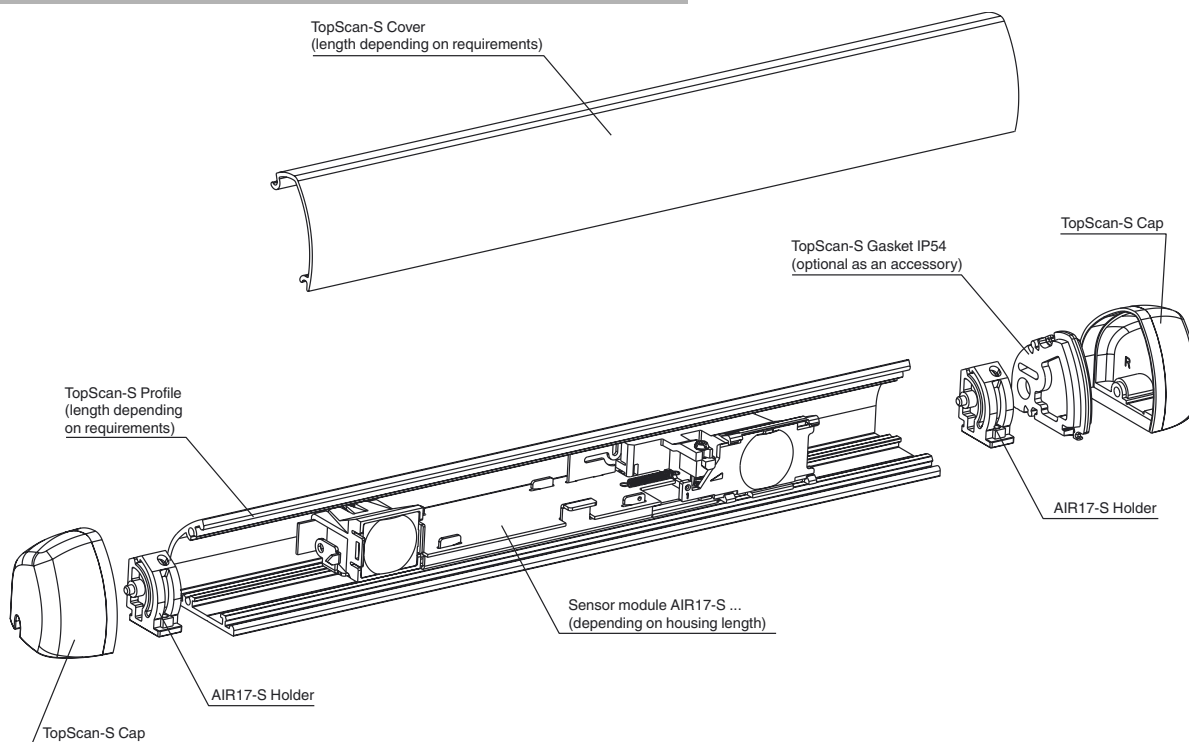

Additional information

Test

If you use the TopScan-S as a protective device, the device must be tested at regular intervals by the door controller. Only perform the test if no object is detected. We recommend performing the test before each movement of the door. Connect the door controller test signal to the master module via the 6-pin screw terminal (Pin6).

Test sequence:

Time t_0 : The door controller activates the test request.

Time t_1 : Following a switch-on delay of 70 ms max., the sensor must switch to detection mode.

Time t_2 : After 200 ms, the sensor must still be in detection mode.

After this point, the test request from the door controller can be canceled.

This action ends the test and the sensor is available again after about 70 ms.

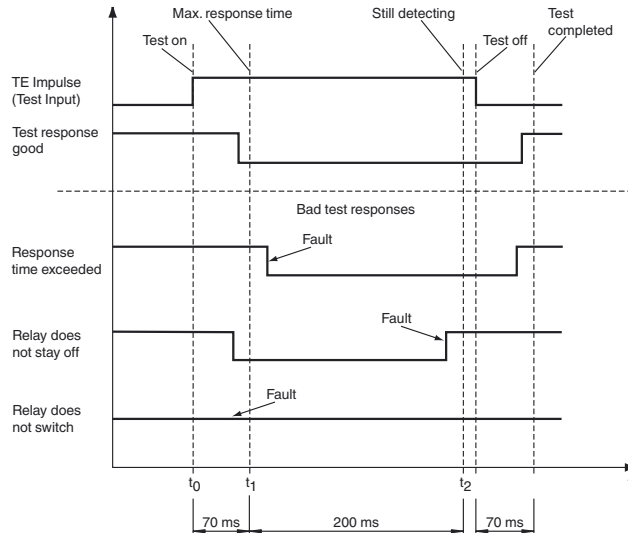

The door controller must query the sensor at times t_1 and t_2 .

The interior and exterior sides of the door must be switched on and off alternately (muting) -> and/or removed from the evaluation by the door controller.

Example:

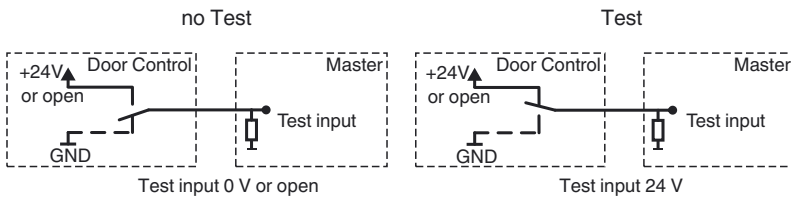

If the device is not used as a safety sensor in accordance with DIN 18650, there is no need to connect the test input.

Detection area

Depending on requirements and the door width, a master module can be extended with up to seven slave modules.

We recommend that the straight transmitter/receiver beam of the relevant sensor module be mounted no further than 10 cm from the closing edge.

Mounting notes regarding different door widths can be found in the following illustration.

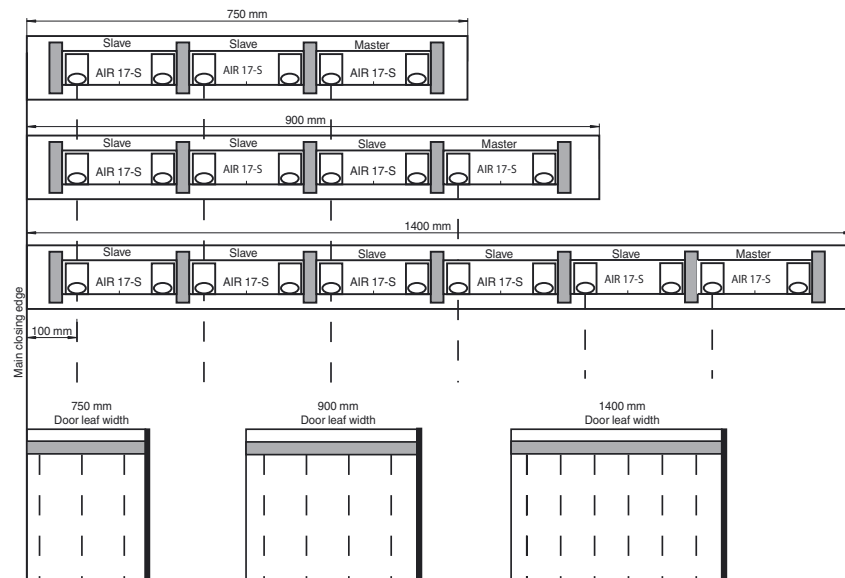

The wider the door, the more slave modules required.