



Model Number

V15-W-5M-PUR-ABG5

Female cordset, M12, 4-pin, PUR cable, screen on pin 5

Features

- Shield applied to Pin 5
- Knurled nut suitable for tool assembly
- Immunity to vibration, with mechanical latching
- Protection degree IP67 / IP68 / IP69K
- Halogen-free

Dimensions

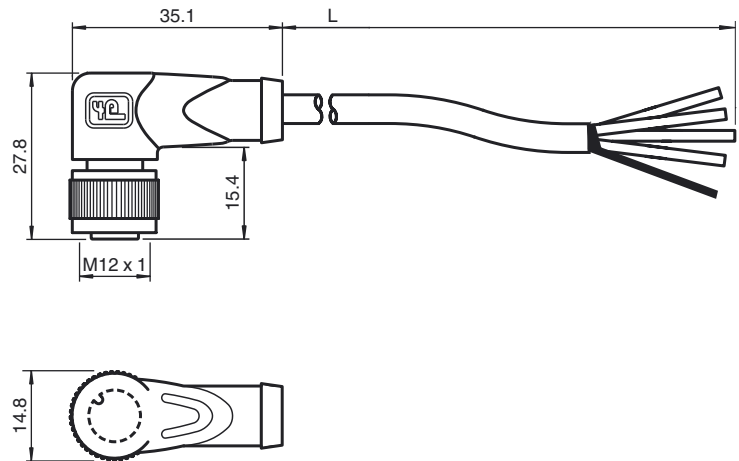

Technical data

General specifications

Number of pins	4 + 1 x screen
Connection 1	socket
Construction type 1	right angle
Threading 1	M12
Connection 2	cable end

Electrical specifications

Operating voltage	U_B	max. 60 V AC/DC
Operating current		max. 4 A
Contact resistance		< 10 mΩ

Ambient conditions

Ambient temperature	Body: -40 ... 90 °C (-40 ... 194 °F) cable, flexing: -25 ... 80 °C (-13 ... 176 °F) cable, fixed: -25 ... 80 °C (-13 ... 176 °F)
Pollution Degree	3

Mechanical specifications

Contact elements	spring-loaded contact socket	
Pin diameter	1 mm	
Protection degree	IP67 / IP68 / IP69K	
Material		
Contacts	CuSn / Au	
Contact surface	Au	
Body	TPU, black	
Cable	PUR	
Slotted nut	Diecast zinc	
Core insulation	PP	
Cable	fine-strand, flexible	
Sheath diameter	Ø 4.8 mm	
Bending radius	> 10 x cable diameter, moving 5 x cable diameter, single bend	
Color	grey	
Cores	4 x 0.34 mm ²	
Conductor construction	19 x 0.15 mm Ø	
Shield	grid covering 85 %	
Length	L	5 m
Flammability		
Contact material	94 HB	
Housing	94 V-2	

Compliance with standards and directives

Standard conformity	
Protection degree	EN 60529:2000

Electrical connection

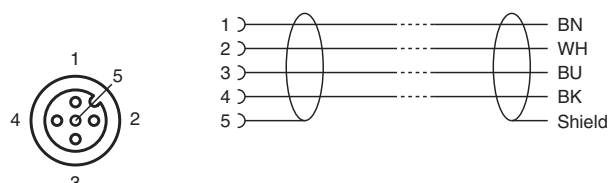



Standards	IEC 61076-2-101:2008 Limited to a maximum of 500 VDC for insulation strength and surge voltage strength
Flammability	Grip: UL 94

Release date: 2013-08-16 16:20 Date of issue: 2013-08-29 199081_eng.xml