

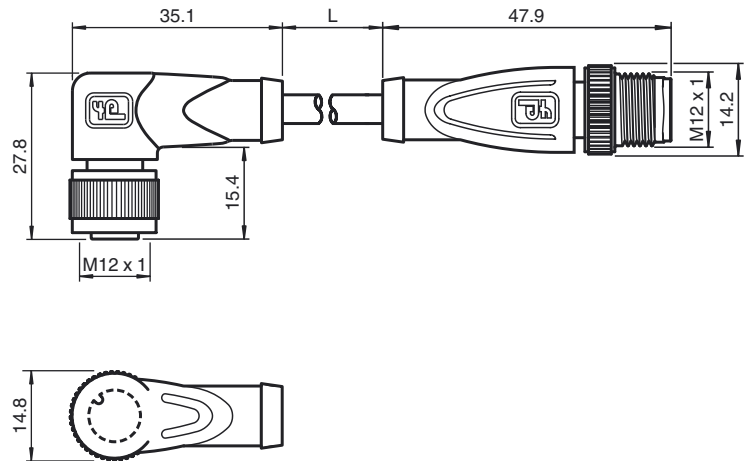

Dimensions



Model Number

V15-W-1M-PUR-V15-G

Connecting cable, M12 to M12, PUR cable 5-pin

Features

- Knurled nut suitable for tool assembly
- Immunity to vibration, with mechanical latching
- Gold plated contacts
- Degree of protection IP67 / IP68 / IP69K
- Halogen-free
- Suitable for 2-, 3- and 4-wire technology

Technical data

General specifications

Number of pins	5
Connection 1	socket
Construction type 1	right angle
Threading 1	M12
Connection 2	Male connector
Construction type 2	straight
Threading 2	M12

Electrical specifications

Operating voltage	U_B	max. 60 V DC
Test voltage		> 1500 V _{eff} AC
Operating current		max. 4 A
Volume resistance		< 5 mΩ

Ambient conditions

Ambient temperature	-25 ... 100 °C (-13 ... 212 °F) for temperatures over 80 °C (176 °F) reduced elongation at tear
Pollution Degree	3

Mechanical specifications

Contact elements	spring-loaded contact socket
Pin diameter	1 mm
Degree of protection	IP67 / IP68 / IP69k
Material	
Contacts	CuSn / Au
Contact surface	Au
Body	TPU, black
Cable	PUR
Slotted nut	Diecast zinc
Sleeve connector	Diecast zinc
Core insulation	PP
Cable	fine-strand, flexible
Sheath diameter	Ø4.8 mm
Bending radius	> 10 x cable diameter, moving
Color	grey
Cores	5 x 0.34 mm ²
Conductor construction	19 x 0.15 mm Ø
Length	L 1 m
Flammability	
Contact material	94 V-2
Housing	94 V-2

Electrical connection



Release date: 2014-06-23 16:05 Date of issue: 2014-06-23 200813_eng.xml

Refer to "General Notes Relating to Pepperl+Fuchs Product Information".