

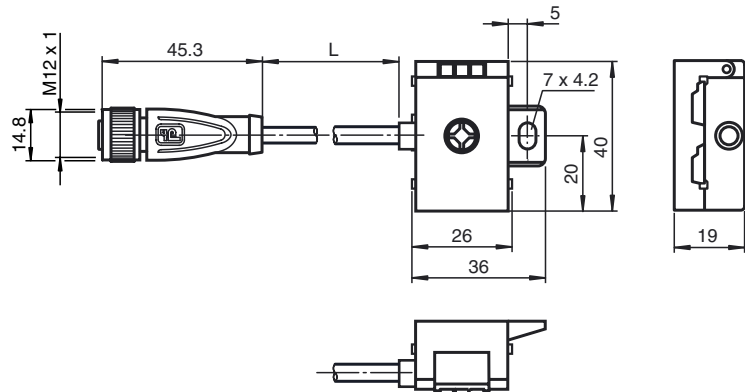

## Dimensions



## Model number

### VAZ-2T1-FK-4M-PUR-V1-G

Splitter box AS-Interface and auxiliary voltage to 1 x M12 round connector

## Features

- Compact design
- Fixing component with captive screw
- Simple and fast mounting
- Gold plated contacts
- Housing made of fiberglass reinforced plastic
- Oil and abrasion resistant PUR line appropriate for drag chains
- Immunity to vibration
- Reverse polarity protected and yellow marking for AS-Interface flat cable
- Halogen-free

## Electrical connection

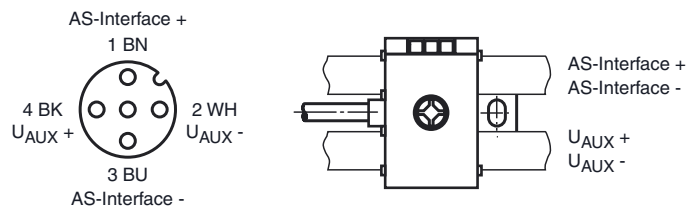

## Technical data

### General specifications

Construction type	Socket, straight Flat cable terminals AS-Interface/ext. auxiliary voltage
-------------------	--

### Electrical specifications

Rated operating voltage	$U_e \leq 35 \text{ V PELV (AS-Interface, } U_{AUX})$
Rated operating current	$I_e \leq 4 \text{ A}$
Surge protection	$U_{AUX}, U_{in}$ : Over voltage category III, safe isolated power supplies (PELV)
Pulse withstand voltage	500 V

### Electrical isolation

AUX/AS-Interface	safe isolation, Rated insulation voltage 40 V DC
------------------	--

### Ambient conditions

Ambient temperature	-25 ... 75 °C (-13 ... 167 °F)
Storage temperature	-25 ... 85 °C (-13 ... 185 °F)
Pollution Degree	3

### Mechanical specifications

Degree of protection	IP67 / IP68 / IP69k
Connection	AS-Interface flat cable: Insulation penetration technology Flat cable ext. auxiliary voltage $U_{AUX}$ : Insulation penetration technology Plug connection: M12 x 1 socket (V1)

### Material

Housing	PA 66-GF25 Ultramid
Body	black PUR
Cable	PUR

### Cable

Sheath diameter	Ø4.8 mm
Color	grey
Cores	4 x 0.34 mm <sup>2</sup>
Length	L 4 m
Mass	150 g
Tightening torque, fastening screws	1.65 Nm

### Compliance with standards and directives

Standard conformity	
Degree of protection	EN 60529