



Model Number

UB800-F12-EP-V15

Single head system

Features

- Evaluation limits can be taught-in
- Selectable sound lobe width
- Synchronization options
- Very small unusable area
- Temperature compensation

Diagrams

Characteristic response curve

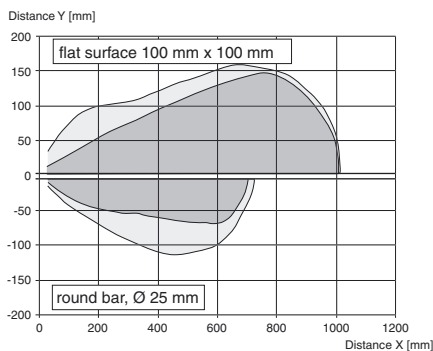

Technical data

General specifications	
Sensing range	30 ... 800 mm
Adjustment range	50 ... 800 mm
Unusable area	0 ... 30 mm
Standard target plate	100 mm x 100 mm
Transducer frequency	approx. 310 kHz
Response delay	approx. 100 ms
Indicators/operating means	
LED green	Operating display
LED yellow	Evaluation range indicator, Ready for programming
LED red	Ready for programming, Fault
Electrical specifications	
Operating voltage U_B	10 ... 30 V DC
No-load supply current I_0	≤ 30 mA
Input/Output	
Synchronization	1 synchronous connection, bi-directional 0-level: $-U_B \dots +1$ V 1-level: $+4$ V $\dots +U_B$ input impedance: > 12 kΩ synchronization pulse: ≥ 100 μs, synchronization interpulse period: ≥ 2 ms
Synchronization frequency	
Common mode operation	≤ 45 Hz
Multiplex operation	≤ 45/n Hz, n = number of sensors
Input	
Input type	1 program input Switching distance 1: $-U_B \dots +1$ V, Switching distance 2: $+3$ V $\dots +U_B$ Input impedance: > 10 kΩ
Pulse length	≥ 1 s
Output	
Output type	Push-pull output, short-circuit protected, reverse polarity protected
Rated operating current I_e	200 mA, short-circuit/overload protected
Default setting	Switch point A1: 50 mm, Switch point A2: 800 mm, wide sound lobe
Voltage drop U_d	≤ 3 V
Repeat accuracy	≤ 1 %
Switching frequency f	6 Hz
Range hysteresis H	1 % of the set operating distance
Temperature influence	± 1.5 % of full-scale value
Ambient conditions	
Ambient temperature	-15 ... 70 °C (5 ... 158 °F)
Storage temperature	-40 ... 85 °C (-40 ... 185 °F)
Mechanical specifications	
Connection type	Connector M12 x 1, 5-pin
Protection degree	IP54
Material	
Housing	Frame: nickel plated, die cast zinc, Laterals: glass-fiber reinforced plastic PC
Transducer	
	epoxy resin/hollow glass sphere mixture; foam polyurethane, cover PBT
Mass	60 g
Compliance with standards and directives	
Standard conformity	
Standards	EN 60947-5-2:2007 IEC 60947-5-2:2007

Approvals and certificates

UL approval	cULus Listed, General Purpose
CSA approval	cCSAus Listed, General Purpose
CCC approval	CCC approval / marking not required for products rated ≤36 V

Release date: 2011-08-16 09:03 Date of issue: 2013-10-25 202066_eng.xml

Dimensions

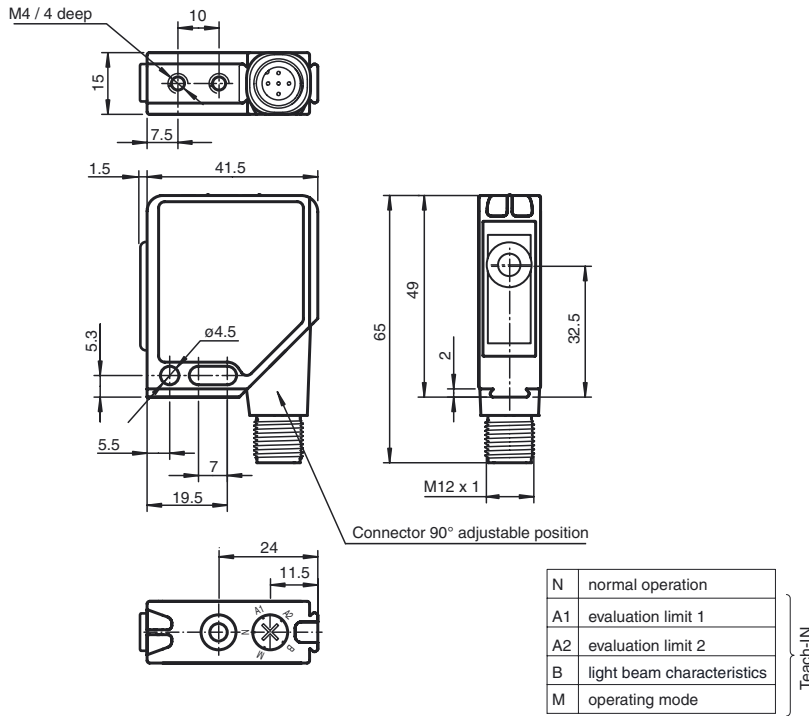

Electrical Connection

Standard symbol/Connections:
(version EP, pnp/npn)

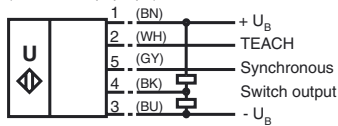

Core colours in accordance with EN 60947-5-2.

Pinout

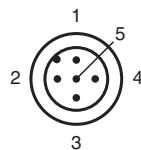

Wire colors in accordance with EN 60947-5-2

1	BN	(brown)
2	WH	(white)
3	BU	(blue)
4	BK	(black)
5	GY	(gray)

Additional Information

Programmable operation modes

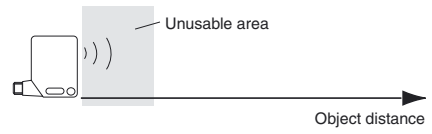

1. Switching point mode

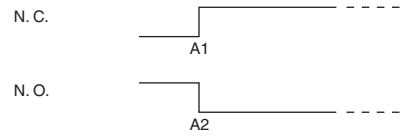

2. Window mode

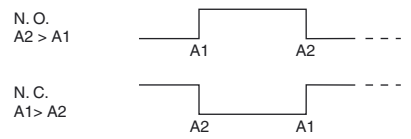

3. Hysteresis mode

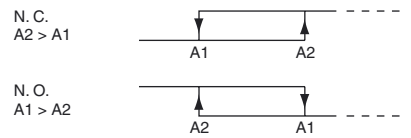

Accessories

OMH-K01

dove tail mounting clamp

OMH-K02

dove tail mounting clamp

OMH-K03

dove tail mounting clamp

OMH-01

Mounting aid for round steel ø 12 mm or sheet 1.5 mm ... 3 mm

OMH-06

Mounting aid for round steel ø 12 mm or sheet 1.5 mm ... 3 mm

OMH-MLV12-HWG

Mounting bracket for series MLV12 sensors

OMH-MLV12-HWK

Mounting bracket for series MLV12 sensors

V15-G-2M-PVC

Female cordset, M12, 5-pin, PVC cable

V15-W-2M-PUR

Female cordset, M12, 5-pin, PUR cable

Function description

The sensor can be fully programmed by means of a push button and a selector switch on the top of the housing. A special feature of this sensor is the option of adapting the breadth of the ultrasonic beam to suit the ambient conditions at the point of use.

Normal operation

During normal operation the output stage of the sensor operates in accordance with the taught-in evaluation limits, the programmed mode of operation and characteristic of the sonic beam. In this made the selector switch must remain at the N position.

LED	Condition
Green LED	Continuous: Ready for operation
Yellow LED	Object detected within the evaluation limits

If the selector switch is not in the N position when the power supply is switched on, then this is indicated by simultaneous flashing of the green and yellow LEDs. However, the function of the output stage is as for the switch position N.

Teaching in of the switching points:

Within a time window of 5 minutes after switch-on of the power supply the sensor is ready for adaptation of the switching points to the requirements of the respective application.

Note: For switching point mode, depending on the desired output behaviour (N. O. or N. C.), it is necessary to teach only one switching point, either A1 or A2. For the operating modes window mode and hysteresis mode, both A1 and A2 are required to be taught to the sensor.

- Place the object that is to be detected at the desired position.
- Set the selector switch to position A1 or A2.
- Now actuate the TEACH-IN button.

LED	before pressing button	on pressing button	after pressing button
Green	Off	Off	On
Yellow	Flashes: Positive detection of object	On	switching output state
Red	Flashes: No object detected On: Object not positively detected	Off	Off

- The teach-in procedure for the evaluation range limit can be repeated by repeatedly actuating the TEACH-IN button.
- Return the selector switch to position N.

Note: Acceptance of the switching point into the permanent memory of the sensor does not take place until the selector switch is reset to N. If this acceptance does not take place within a time window of 5 minutes, the sensor continues to operate with unchanged values and the red and yellow LEDs flash.

With the Output functions window mode and hysteresis mode, the teach in sequence of the switching points is arbitrary. With the output function switching point mode, the last taught point (A1 or A2) determines the output behaviour (N. O. or N. C.).





Alternatively, the switching points can be set electrically, via the teach-in input. In this case the selector switch is left in the N position. The two switching points are taught in by applying the potentials $-U_B$ (A1) and $+U_B$ (A2), respectively, for at least 500 ms to the teach-in input.

Parameter assignment of the operating mode

Within a time window of 5 minutes from switching on the power supply the sensor is ready for adaptation of the output function.

- Set the selector switch to position M (Mode). The current set operating mode is indicated by the flashing sequence of the green LED.
- The optional operating modes are selected by briefly actuating the TEACH-IN button (See flashing sequence of the green LED).

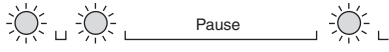
Release date: 2011-08-16 09:03 Date of issue: 2013-10-25 202066_eng.xml

Operating mode	Flashing sequence of the green LED	T button
Switching point mode		
Window mode		
Hysteresis mode		





- Return the selector switch to position N when the desired operating mode is displayed.

Note: Acceptance of the operating mode into the permanent memory of the sensor does not take place until the selector switch is set to N. If this acceptance does not take place within a time window of 5 minutes, the sensor continues to operate with unchanged operating mode and the red and yellow LEDs flash.

Parameter assignment of the ultrasonic beam breadth

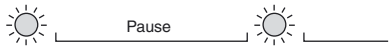
Within a time window of 5 minutes from switching on the power supply the sensor is ready for adaptation of the ultrasonic beam breadth.

- Set the selector switch to position B (Beam). The flashing sequence of the green LED indicates the currently set ultrasonic beam breadth.
- The optional beam breadths are selected by brief actuation of the TEACH-IN button (See flashing sequence of the green LED).

Characteristic	Flashing sequence of the green LED	T-Button
Narrow beam		
Medium beam		
Broad beam		

- Return the selector switch to position N when the desired beam breadth is indicated.

Note: Acceptance of the ultrasonic beam breadth into the permanent memory of the sensor does not take place until the selector switch is set to N. If this acceptance does not take place within the 5 minute time window, the sensor continues its operation with an unchanged ultrasonic beam breadth and the red and yellow LEDs flash.

Synchronisation

A synchronisation connection is provided for the suppression of mutual interference. If this is unused, or connected to 0V, then the sensor operates with an internally generated clock-pulse rate. The synchronisation of a number of sensors can be achieved by the following means.

External synchronisation:

The sensor can be synchronised by the external application of a square-wave voltage. A synchronisation pulse at the synchronisation input leads to the execution of a measuring cycle. The pulse width must be greater than 1.2 ms. The measuring cycle starts with the falling ramp. A low level > 1 s or an open synchronisation input leads to the normal operation of the sensor. A high level at the synchronisation input deactivates the sensor.

Two operating modes are possible.

- A number of sensors are triggered by the same synchronisation signal. The sensors operate in common mode.
- The synchronisation pulses are fed cyclically to one sensor at a time. The sensors operate in multiplex mode.

Self-synchronisation:

The synchronisation connections of up to 5 sensors are connected together to provide the option of self-synchronisation. When the operating voltage is switched on these sensors operate in multiplex mode. The switch-in delay increases depending on the number of sensors to be synchronised. Synchronisation cannot take place during teach-in and vice-versa. The sensors must be operated unsynchronised for the teaching-in of the switch points.

Note:

If the synchronisation option is not used, then the synchronisation input is connected to earth (0V) or the sensor is operated with a V1 connection cable (4-pole).

Release date: 2011-08-16 09:03 Date of issue: 2013-10-25 202066_eng.xml