



Model Number

V1-W-1M-PVC

Female cordset, M12, 4-pin, PVC cable

Features

- Knurled nut suitable for tool assembly
- Immunity to vibration, with mechanical latching
- Gold plated contacts
- Degree of protection IP67 / IP68 / IP69K

Dimensions

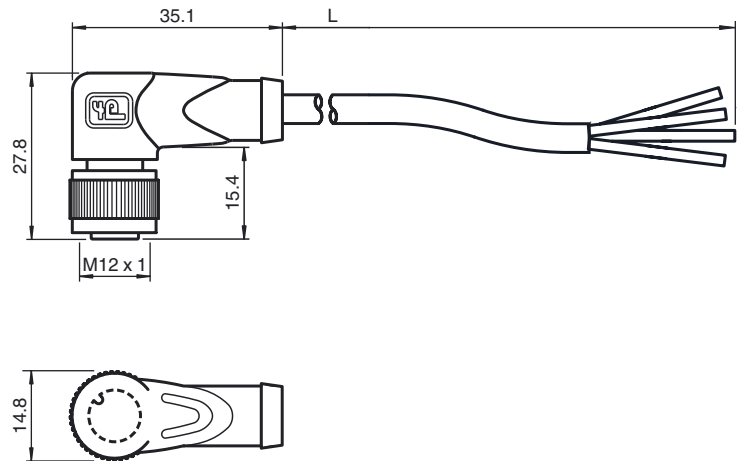

Technical data

General specifications

Number of pins 4

Electrical specifications

Operating voltage U_B max. 250 V AC/DC
 Operating current I_B max. 4 A
 Contact resistance < 10 m Ω

Ambient conditions

Ambient temperature Body: -40 ... 90 °C (-40 ... 194 °F)
 cable, fixed: -25 ... 70 °C (-13 ... 158 °F)
 cable, flexing: -5 ... 70 °C (23 ... 158 °F)
 Pollution Degree 3

Mechanical specifications

Contact elements spring-loaded contact socket
 Pin diameter 1 mm
 Degree of protection IP67 / IP68 / IP69k

Material

Contacts CuSn / Au
 Contact surface Au
 Body TPU, black
 Cable PVC
 Slotted nut Diecast zinc
 Core insulation PVC
 Cable fine-strand, flexible
 Sheath diameter \varnothing 4.8 mm
 Bending radius > 10 x cable diameter, moving
 Color grey
 Cores 4 x 0.34 mm²
 Conductor construction 19 x 0.15 mm \varnothing
 Length L 1 m

Flammability

Contact material 94 HB
 Housing 94 V-2
 Cable flame-resistant

Compliance with standards and directives

Standard conformity
 Degree of protection EN 60529:2000
 Standards IEC 61076-2-101:2008

Electrical connection

