

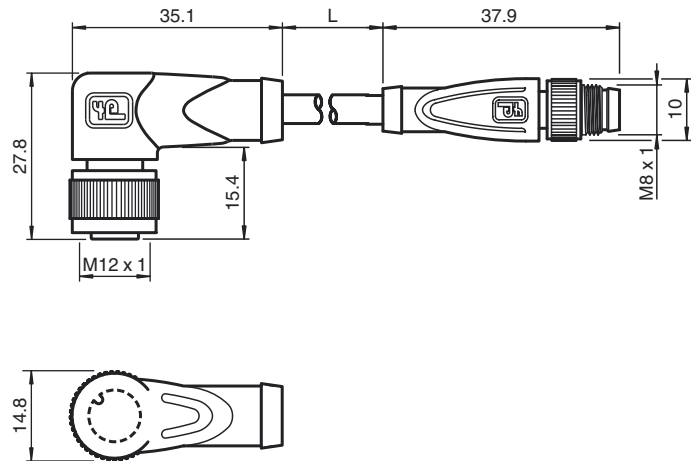

Dimensions



Model Number

V11-W-3M-PUR-V3-GM

Connection cable, M12 to M8, PUR cable, 3-pin

Features

- Knurled nut suitable for tool assembly
- Immunity to vibration, with mechanical latching
- Gold-plated and machined contacts
- Halogen-free
- Resistant to microbes and hydrolysis

Technical data

General specifications

Number of pins	3
Connection 1	socket
Construction type 1	right angle
Threading 1	M12
Connection 2	Male connector
Construction type 2	straight
Threading 2	M12

Electrical specifications

Operating voltage	U_B	max. 60 V AC/DC
Test voltage		> 1500 V _{eff} AC
Operating current		max. 3 A
Volume resistance		< 5 mΩ

Ambient conditions

Ambient temperature	cable, fixed: -40 ... 80 °C (-40 ... 176 °F) cable, flexing: -20 ... 80 °C (-4 ... 176 °F)
Pollution Degree	3

Mechanical specifications

Contact elements	spring-loaded contact socket
Pin diameter	1 mm
Protection degree	IP67
Material	
Contacts	CuSn / Au
Contact surface	Au
Body	TPU, green
Cable	PUR
Slotted nut	Diecast zinc
Sleeve connector	Diecast zinc
Core insulation	PP
Cable	fine-strand, flexible
Sheath diameter	Ø 4.3 mm
Bending radius	> 15 x cable diameter, induced > 8 x cable diameter, fixed
Color	grey
Cores	3 x 0.25 mm ²
Conductor construction	14 x 0.15 mm Ø
Length	L 3 m

Electrical connection

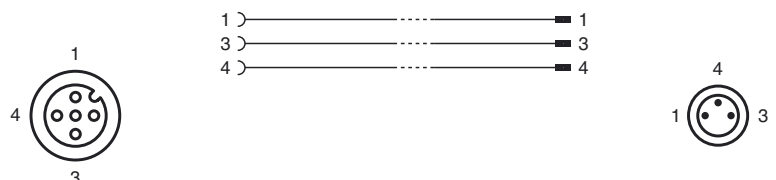

Release date: 2013-08-14 16:31 Date of issue: 2013-08-14 211561_eng.xml

Refer to "General Notes Relating to Pepperl+Fuchs Product Information".