



**Model Number**

**V1-W-BK3M-PUR-U**

Female cordset, M12

**Features**

- UL Recognized Component
- Suitable for drag chains
- Knurled nut suitable for tool assembly
- Immunity to vibration, with mechanical latching
- Halogen-free
- Gold plated contacts

**Dimensions**

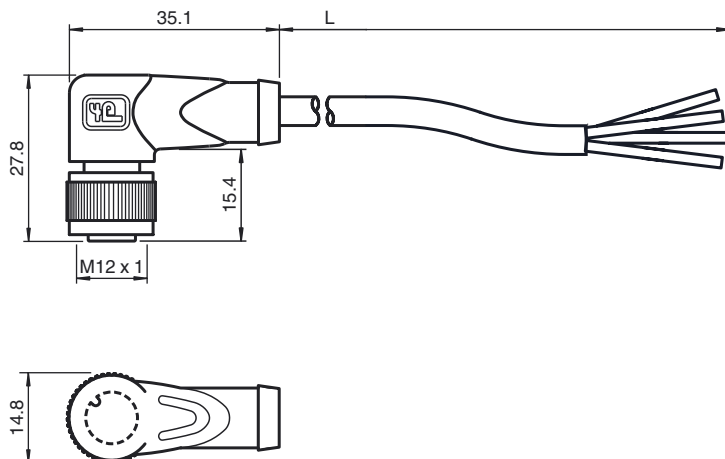

**Technical data**

**General specifications**

Number of pins	4
Connection 1	socket
Construction type 1	right angle
Threading 1	M12
Connection 2	cable end
UL File Number	E231213

**Electrical specifications**

Operating voltage	$U_B$	max. 250 V AC/DC
Operating current		max. 4 A
Volume resistance		< 5 mΩ

**Ambient conditions**

Ambient temperature	Body: -40 ... 90 °C (-40 ... 194 °F) cable, fixed: -40 ... 80 °C (-40 ... 176 °F) cable, flexing: -20 ... 80 °C (-4 ... 176 °F)
Pollution Degree	3

**Mechanical specifications**

Contact elements	spring-loaded contact socket
Pin diameter	1 mm
Degree of protection	IP67 / IP68 / IP69k
Material	
Contacts	CuSn / Au
Contact surface	Au
Body	TPU, black
Cable	PUR
Slotted nut	Diecast zinc
Core insulation	PP
Cable	extra-fine wire, flexible
Sheath diameter	Ø 4.3 mm
Bending radius	> 10 x cable diameter, moving > 5 x cable diameter, fixed
Color	black
Cores	4 x 0.34 mm <sup>2</sup>
Conductor construction	42 x 0.1 mm Ø
Length	L 3 m
Drag chain suitability	
Drag chain cycles	≥ 5000000
Motion velocity	≤ 3.3 m/s
Torsional stress	± 180 °/m
Flammability	
Contact material	HB
Housing	V-2
Cable	FT2

**Electrical connection**

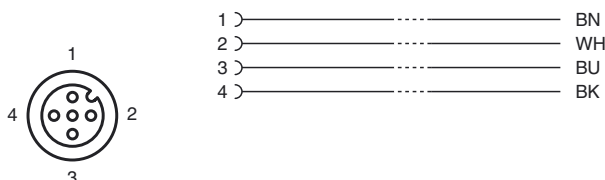

Release date: 2014-05-28 09:42 Date of issue: 2014-05-28 219133\_eng.xml

**Compliance with standards and directives**

Standard conformity

Degree of protection	EN 60529:2000
Standards	IEC 61076-2-101:2008
Flammability	Body: UL 94 Line: UL 1581 Section 1061; IEC 60332-1-2:2004
Halogen-free	IEC 60754-1:1994

**Approvals and certificates**

UL approval

Maximum permissible operating voltage	≤ 30 V
Maximum permissible ambient temperature	≤ 80 °C (≤ 176 °F)

Release date: 2014-05-28 09:42 Date of issue: 2014-05-28 219133\_eng.xml