



Model Number

V1-W-A2-BK20M-PUR-U

Cable socket, M12, LED, 4-pin, PUR cable

Features

- UL Recognized Component
- Built-in LED, as operating and function indicator
- Knurled nut suitable for tool assembly
- Immunity to vibration, with mechanical latching
- Gold-plated and machined contacts
- Flame resistant cable
- Resistant to microbes and hydrolysis
- Halogen-free

Dimensions

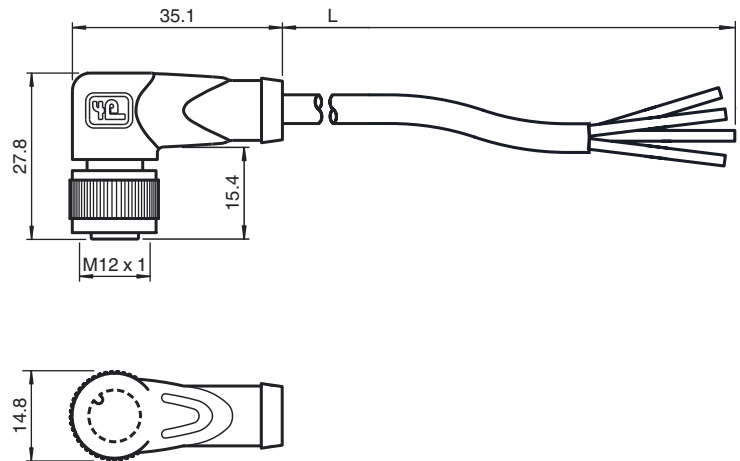

Technical data

General specifications

Number of pins	4
Connection 1	socket
Construction type 1	right angle
Threading 1	M12
Connection 2	cable end

Indicators/operating means

LED green	Operating display
LED yellow	Functional display NO contact

Electrical specifications

Operating voltage	U_B	max. 24 V DC \pm 15%
Operating current		max. 4 A
Contact resistance		< 10 m Ω

Ambient conditions

Ambient temperature	cable, fixed: -40 ... 80 °C (-40 ... 176 °F) cable, flexing: -20 ... 80 °C (-4 ... 176 °F)
Pollution Degree	3

Mechanical specifications

Contact elements	spring-loaded contact socket
Pin diameter	1 mm
Degree of protection	IP67 / IP68 / IP69k
Material	
Contacts	CuSn / Au
Contact surface	Au
Body	TPU, transparent
Cable	PUR
Slotted nut	Diecast zinc
Core insulation	PP
Cable	extra-fine wire, flexible
Sheath diameter	\varnothing 4.3 mm
Bending radius	> 10 x cable diameter, moving
Color	black
Cores	4 x 0.34 mm ²
Conductor construction	42 x 0.1 mm \varnothing
Length	L 20 m
Flammability	
Contact material	94 HB
Housing	94 V-2

Compliance with standards and directives

Standard conformity	
Degree of protection	EN 60529:2000
Standards	IEC 61076-2-101:2008

Electrical connection

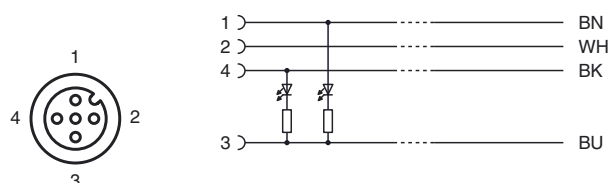



Approvals and certificates

UL approval cURus AWM 20549 AWM I/II A/B 80°C 300V FT2 (cable)

Release date: 2014-03-25 14:19 Date of issue: 2014-03-25 223119_eng.xml