



Model Number

ML9-54-G/25/136/115b

Retroreflective sensor
with fixed cable and M12 connector, 4-pin

Features

- Ultra bright LEDs for power on, pre fault indication and switching state
- Flashing power on LED in case of short-circuit
- TEACH-IN
- Automatic adjustment in case of soiling in contrast detection mode
- Not sensitive to ambient light, even with switched energy saving lamps
- Protected against mutual interference (no cross-talk)
- Protection class II

Dimensions

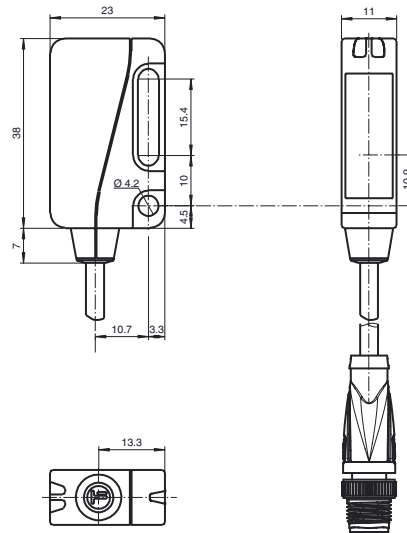

Electrical connection

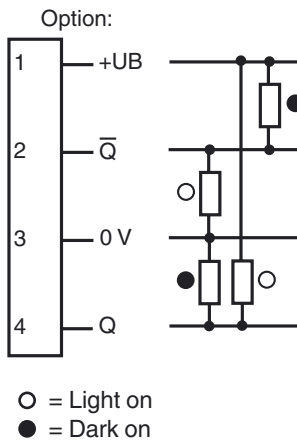

Pinout

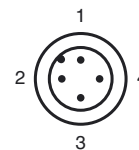

Indicators/operating means

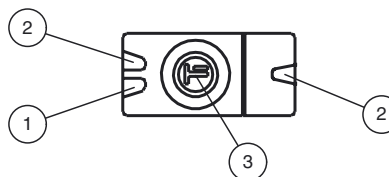

| | |
|---|------------|
| 1 | LED green |
| 2 | LED yellow |
| 3 | Teach-In |

Release date: 2014-07-21 13:25 Date of issue: 2014-07-21 223658_eng.xml

Refer to "General Notes Relating to Pepperl+Fuchs Product Information".

Pepperl+Fuchs Group
www.pepperl-fuchs.com

USA: +1 330 486 0001
fa-info@us.pepperl-fuchs.com

Germany: +49 621 776 4411
fa-info@de.pepperl-fuchs.com

Singapore: +65 6779 9091
fa-info@sg.pepperl-fuchs.com

Technical data**General specifications**

| | |
|----------------------------|--|
| Effective detection range | 0 ... 3.5 m in TEACH mode 0 ... 5.7 m in normal mode |
| Reflector distance | 0 ... 3.5 m in TEACH mode 0 ... 5.7 mm in normal mode |
| Threshold detection range | 7.6 m |
| Reference target | H85-2 reflector |
| Light source | LED |
| Light type | modulated visible red light , 660 nm |
| Polarization filter | yes |
| Angle deviation | max. $\pm 1^\circ$ |
| Diameter of the light spot | approx. 40 mm at detection range 1 m |
| Angle of divergence | 1.7 ° |
| Ambient light limit | 40000 Lux |

Functional safety related parameters

| | |
|--------------------------------|--------|
| MTTF _d | 1050 a |
| Mission Time (T _M) | 20 a |
| Diagnostic Coverage (DC) | 0 % |

Indicators/operating means

| | |
|---------------------------|--|
| Operation indicator | LED green, statically lit Power on , Undervoltage indicator: Green LED, pulsing (approx. 0.8 Hz) , short-circuit : LED green flashing (approx. 4 Hz) |
| Function indicator | LED yellow: switching state ; Stability control ; Teach-In |
| Control elements | Teach-In key |
| Contrast detection levels | 10 % - clean, water filled PET bottles |

Electrical specifications

| | | |
|------------------------|----------------|--------------------------|
| Operating voltage | U _B | 10 ... 30 V DC , class 2 |
| Ripple | | max. 10 % |
| No-load supply current | I ₀ | < 20 mA at 24 V DC |

Output

| | | |
|---------------------|--|---------|
| Switching type | light on | |
| Signal output | 2 push-pull (4 in 1) outputs, complementary, short-circuit proof, reverse polarity protected | |
| Switching voltage | max. 30 V DC | |
| Switching current | max. 100 mA | |
| Switching frequency | f | 1000 Hz |
| Response time | | 500 μs |

Ambient conditions

| | |
|---------------------|--------------------------------|
| Ambient temperature | -20 ... 60 °C (-4 ... 140 °F) |
| Storage temperature | -40 ... 75 °C (-40 ... 167 °F) |

Mechanical specifications

| | |
|----------------------|---|
| Degree of protection | IP67 |
| Connection | 200 mm connecting cable with 4-pin, M12x1 connector |
| Material | |
| Housing | PC (glass-fiber-reinforced Makrolon) |
| Optical face | glass |
| Mass | approx. 25 g |

Compliance with standards and directives

| | |
|---------------------|---|
| Standard conformity | |
| Product standard | EN 60947-5-2:2007 IEC 60947-5-2:2007 |
| Standards | EN 50178, UL 508 |

Approvals and certificates

| | |
|------------------|--|
| Protection class | II, rated voltage ≤ 50 V AC with pollution degree 1-2 according to IEC 60664-1 functional insulation acc. to DIN EN 50178 |
| UL approval | cULus |
| CCC approval | CCC approval / marking not required for products rated ≤ 36 V |

Accessories**OMH-ML9**

Mounting bracket

OMH-ML9-01

Threaded bolt M3

V1-G-2M-PUR

Female cordset, M12, 4-pin, PUR cable

V1-W-2M-PUR

Female cordset, M12, 4-pin, PUR cable

V1-G-5M-PUR

Female cordset, M12, 4-pin, PUR cable

V1-W-5M-PUR

Female cordset, M12, 4-pin, PUR cable

Other suitable accessories can be found at www.pepperl-fuchs.com

Curves/Diagrams

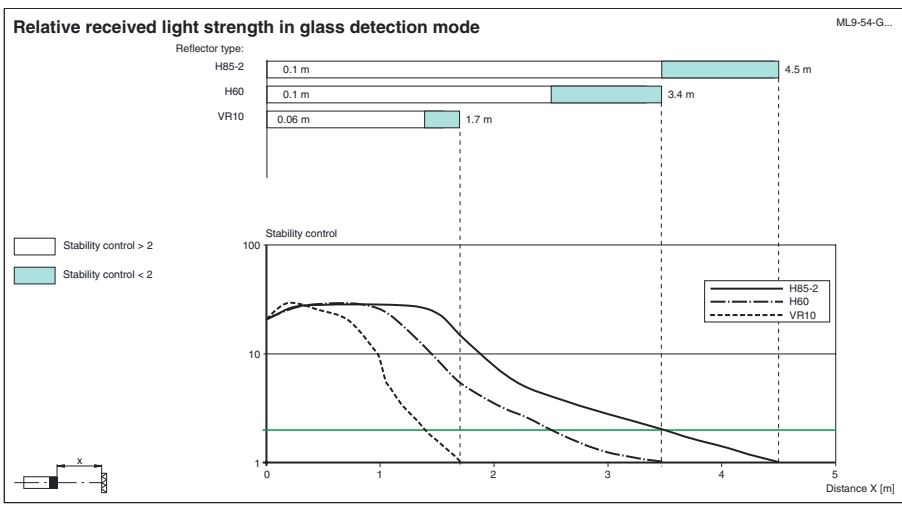
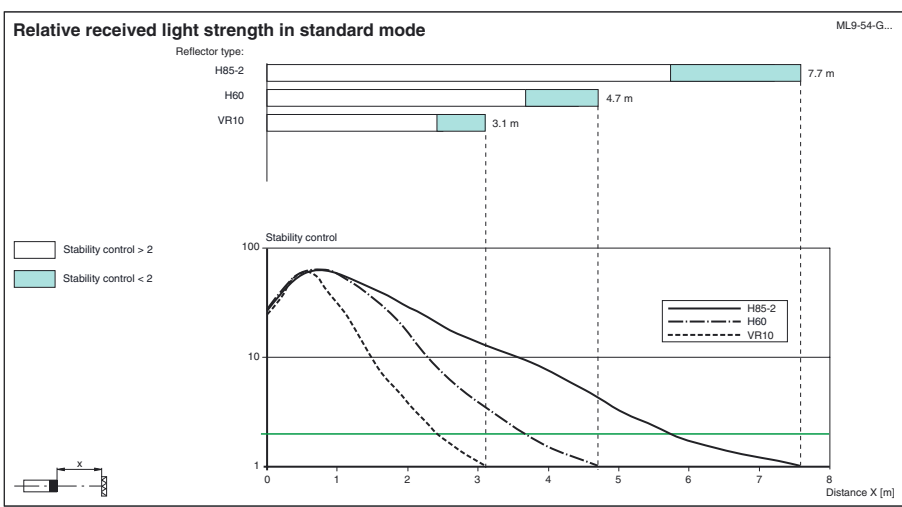
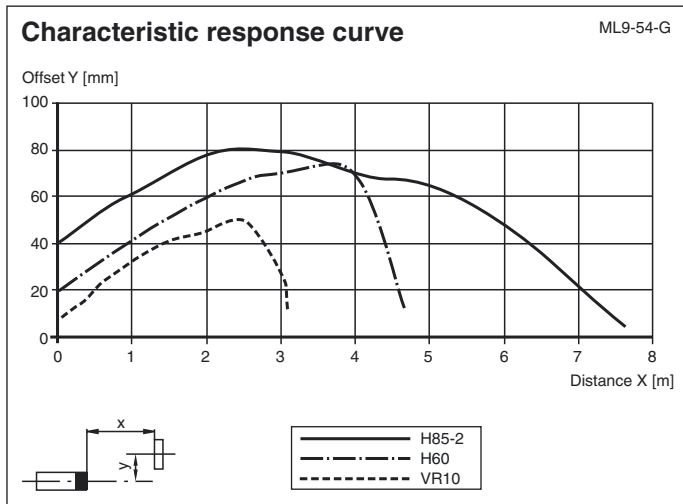

Release date: 2014-07-21 13:25 Date of issue: 2014-07-21 223658_eng.xml

Adjustment instructions

Adjustment instructions for devices with Teach-In

After the operating voltage has been applied, the LED is lit green. The sensor is automatically set to a state of maximum sensitivity (state as supplied) or the state of the most recent Teach-In setting.

Assemble the appropriate reflector opposite the light barrier.

Teach-In using the Teach key

- Align the sensor to an appropriate reflector.
- Press the Teach key - as confirmation, the green display LED is briefly turned off once.

Refer to "General Notes Relating to Pepperl+Fuchs Product Information".

- Hold the Teach key down until the yellow and green display LED is flashing at regular intervals (about 2.5 Hz). Then release the Teach key.
- During the internal set-up of the sensor, the green and yellow display LEDs flash alternately (about 2.5 Hz).
- Teach-In successful: The green and yellow display LEDs are lit. Contrast detection 10% is activated. The device is ready for operation.
- Teach-In not successful: The green and yellow display LEDs flash alternately and rapidly (about 8 Hz) for about 5 seconds. Then the sensor goes to the state with maximum sensitivity. After this happens, repeat the Teach-In procedure, starting with step 1.