



### Model Number

#### VMA-2+P-2M-PUR

Valve connector, Form A, 2+PE, PUR cable

### Features

- Valve connector according EN 175301-803 A/ISO 4400 (previously DIN 43650)
- Moulded seal
- Suitable for drag chains
- freely selectable cable models due to bridged protective earth
- Flame resistant cable
- Halogen-free

### Dimensions

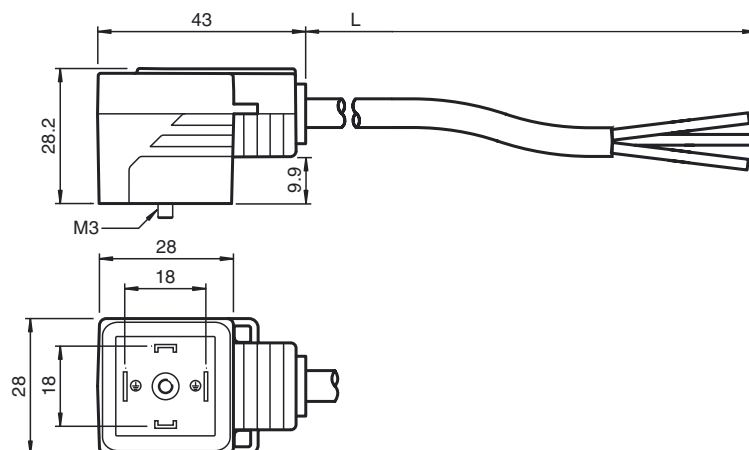

### Technical data

#### General specifications

Number of pins	2 + PE
Connection 1	Valve connector DIN
Construction type 1	right angle
Connection 2	cable end

#### Electrical specifications

Operating voltage	$U_B$	250 V AC/DC
Operating current		max. 10 A
Volume resistance		< 10 m $\Omega$

#### Ambient conditions

Ambient temperature	Body: -25 ... 80 °C (-13 ... 176 °F) cable, flexing: -20 ... 80 °C (-4 ... 176 °F) cable, fixed: -40 ... 80 °C (-40 ... 176 °F)
---------------------	---

Pollution Degree	3
------------------	---

#### Mechanical specifications

Degree of protection	IP65/IP67
Connection	Valve connector Form A

#### Material

Contacts	CuSn
Contact surface	Sn
Body	TPU, black
Cable	PUR
Core insulation	PP

#### Cable

Sheath diameter	$\varnothing$ 4.5 mm
Bending radius	> 50 mm > 22.5 mm, fixed
Color	dark grey (RAL 7021)
Cores	(2 + 1) x 0.5 mm <sup>2</sup> ; 20 AWG
Conductor construction	28 x 0.15 mm $\varnothing$

Length	L	2 m
--------	---	-----

#### Drag chain suitability

Drag chain cycles	$\geq$ 15000000
Motion velocity	$\leq$ 5 m/s
Traverse distance	0.9 m
Acceleration	$\leq$ 30 m/s <sup>2</sup>

### Electrical connection

